



CorePro LED PLC 4P



CorePro LED PLC 9W 840 4P G24q-3

De Philips CorePro LED PL-C integreert LED technologie in een traditionele fluorescentie-lampvorm. Dit product vormt een simpel retrofit-alternatief voor algemene verlichting: het voldoet aan de basiseisen voor verlichting, biedt significante besparingen op energieverbruik en is milieuvriendelijk.

Product gegevens

Algemene informatie	
Lampvoet	G24Q-3 [G24q-3]
Conform EU RoHS-richtlijn	Ja
Nominale levensduur (nom.)	30000 h
Schakelcyclus	50000
Meetreferentie van lichtstroom	Sphere
Eisen aan armatuurontwerp	
Kleurcode	840 [CCT of 4000K (841)]
Bundelhoek (nom.)	120 °
Lichtstroom (nom.)	1000 lm
Kleuraanduiding	Koel Wit (CW)
Gecorreleerde kleurtemperatuur (nom.)	4000 K
Lichtrendement (gespec.) (nom.)	100,00 lm/W
Kleurconsistentie	<6
Kleurweergave-index (nom.)	83
LLMF bij einde nominale levensduur (nom.)	70 %
Bedrijfs- en elektrische gegevens	
Ingangsfrequentie	30000-80000 Hz
Power (Rated) (Nom)	9 W
Lampstroom (max.)	400 mA
Lampstroom (min.)	250 mA

Opstarttijd (nom.)	0,5 s
Opwarmtijd tot 60% lichtopbrengst (nom.)	0.5 s
Arbeidsfactor (nom.)	0.9
Spanning (nom.)	20-50 V
Temperatuur	
T-omgeving (max.)	35 °C
T-omgeving (min.)	-20 °C
T-opslag (max.)	65 °C
T-opslag (min.)	-40 °C
T-behuizing maximaal (nom.)	76 °C
Regelsystemen en dimmers	
Dimbaar	Nee
Mechanische eigenschappen en behuizing	
Productlengte	200 mm
Lampvorm	Buis, enkelkneeps
Goedkeuring en toepassing	
Energie-efficiëntieklasse	F
Energiebesparend product	Yes

CorePro LED PLC 4P

Goedkeuringsmerktekens	TÜV CE-markering RoHS compliance KEMA Keur-certificaat
Energieverbruik kWh/1.000 uur	9 kWh
EPREL-registratienummer	403551
Productgegevens	
Volledige productcode	871869654117300
Productnaam voor bestelling	CorePro LED PLC 9W 840 4P G24q-3
EAN/UPC - Product	8718696541173

Bestelcode	54117300
Lokale code	CPLC9W840Q3
Numerator - Aantal per pak	1
Numerator - Dozen per buitendoos	10
SAP-materiaal	929001200902
Net Weight (Piece)	0,088 kg

Maatschets

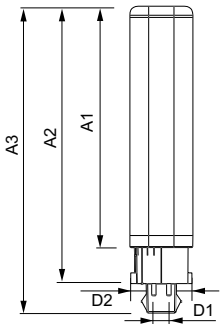

CorePro LED PLC 9W 840 4P G24q-3

Product	D1	D2	A1	A2	A3
CorePro LED PLC 9W 840 4P G24q-3	24,3 mm	28,4 mm	128,8 mm	148 mm	163,6 mm

Fotometrische gegevens

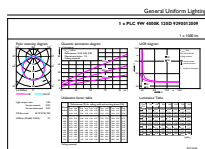

General Information 14

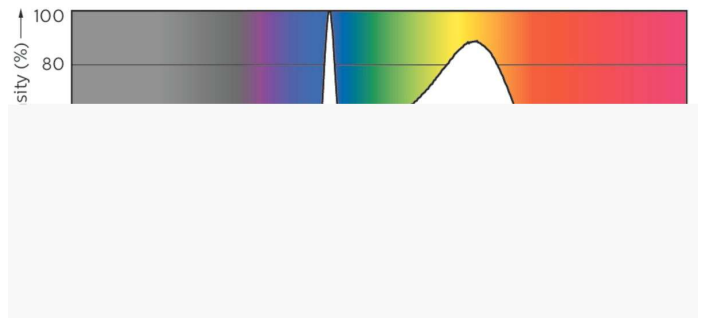

LEDtube PLC 100mm 9W G24Q-3 840 1000lm

LEDtube PLC 100mm 9W G24Q-3 840 1000lm

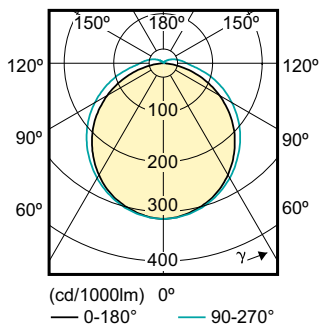

CorePro LED PLC 4P

Levensduur

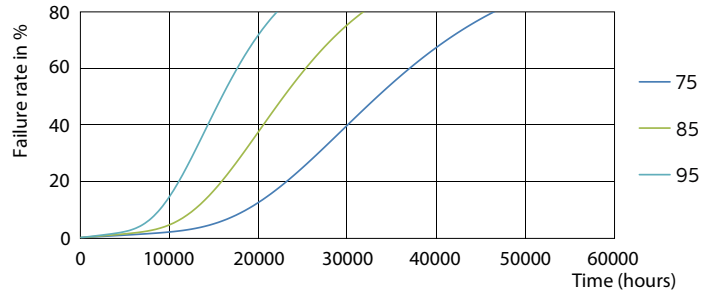
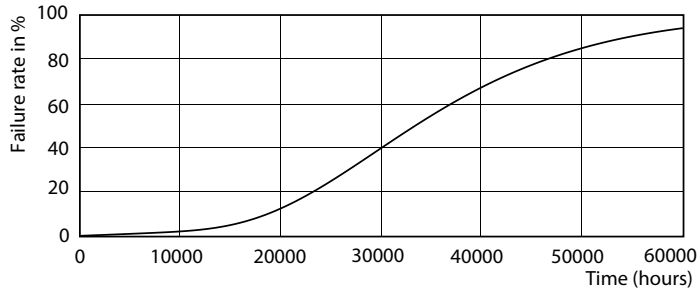

LEDtube PLC 100mm 9W G24Q-3 830 950lm

LEDtube PLC 100mm 9W G24Q-3 830 950lm

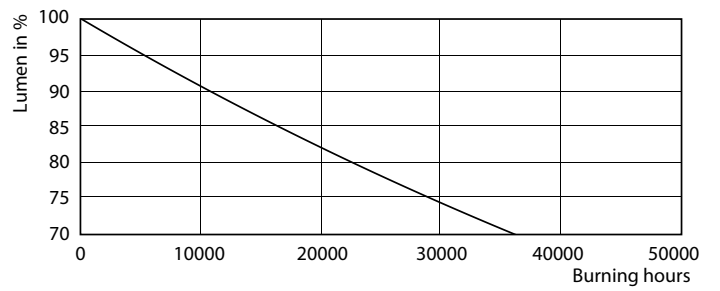
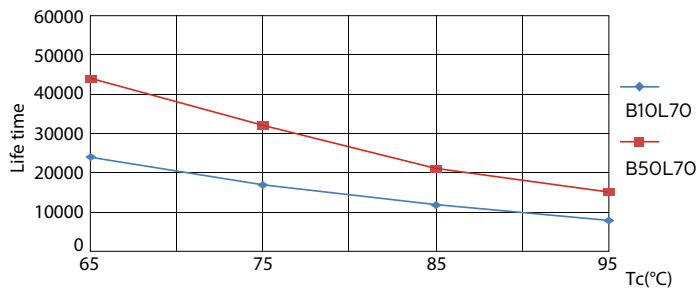

LEDtube PLC 100mm 9W G24Q-3 830 950lm

LEDtube PLC 100mm 9W G24Q-3 830 950lm

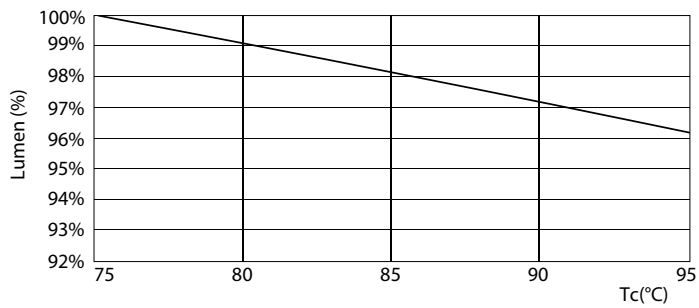

LEDtube PLC 100mm 9W G24Q-3 830 950lm

CorePro LED PLC 4P

