



# CorePro LED PLC 4P



## CorePro LED PLC 9W 840 4P G24q-3

De Philips CorePro LED PLC 4P is een LED-lichtbron in de vorm van een traditionele fluorescentielamp. Dit product vormt de ideale oplossing voor het opwaarderen van TL-verlichting in algemene verlichtingstoepassingen: het voldoet aan de basiseisen voor verlichting, biedt aanzienlijke energiebesparingen en is milieuvriendelijk.

### Product gegevens

Algemene informatie		Opwarmtijd tot 60% licht	
Lamptype	LED		0,5 s
Meetreferentie van lichtstroom	Sphere	Arbeidsfactor	0,9
Schakelcyclus	50.000	Spanning (nom.)	20-50 V
Nominale levensduur	30.000 hr	<b>Operationele temperatuur</b>	
Lampvoet	G24Q-3 [G24q-3]	Omgevingstemperatuurbereik	-20 °C t/m 35 °C
<b>Gegevens lichttechniek</b>		T-behuizing maximaal (nom.)	76 °C
Kleurcode	840 [CCT of 4000K]	<b>Dimbaarheid en regelsystemen</b>	
Bundelhoek (nom.)	120 graden	Dimbaar	Nee
Lichtstroom	1.000 lm	<b>Eigenschappen behuizing en afmetingen</b>	
Kleuraanduiding	Koelwit (CW)	Productlengte	200 mm
Gecorreleerde kleurtemperatuur (nom)	4000 K	Lampvorm	Buis, enkelkneeps
Lichtrendement (nominiaal)	100,00 lm/W	<b>Keurmerken en classificaties</b>	
Kleurconsistentie	<6	Energie-efficiëntielabel	F
Kleurweergave-index (CRI)	83	Energiebesparend product	Ja
LLMF bij einde nominale levensduur (nom.)	70 %	Keurmerken	TUV CE-markering RoHS-conform KEMA-KEUR-certificaat
<b>Bedrijfs- en elektrische gegevens</b>		Energieverbruik kWh/1.000 uur	9 kWh
Ingangsfrequentie	30000-80000 Hz	EPREL-registratienummer	403551
Ingangsfrequentie	30000-80000 Hz	CE-markering	Ja
Energieverbruik	9 W		
Opstarttijd (nom.)	0,5 s		

# CorePro LED PLC 4P

EU RoHS-conform	Ja
<b>Productgegevens</b>	
Full EOC	871869654117300
Productnaam voor bestelling	CorePro LED PLC 9W 840 4P G24q-3
Bestelcode	54117300
Lokale code	CPLC9W840Q3

Numerator - Aantal per pak	1
Numerator - Dozen per buitendoos	10
Materiaalnummer (12NC)	929001200902
Volledige productnaam	CorePro LED PLC 9W 840 4P G24q-3
EAN/UPC - Case	8718696541180

## Maatschets

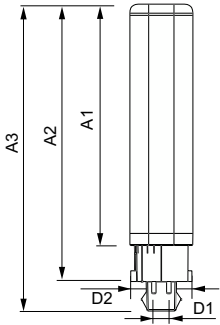

Product	D1	D2	A1	A2	A3
CorePro LED PLC 9W 840 4P G24q-3	24,3 mm	28,4 mm	128,8 mm	148 mm	163,6 mm

## Fotometrische gegevens

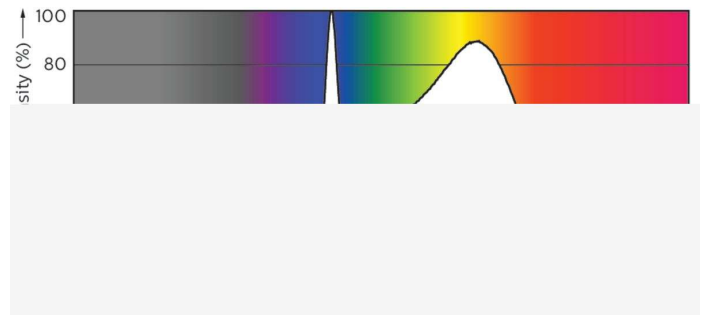
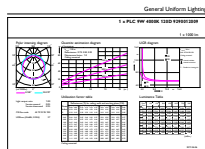

General uniform lighting - CorePro LED PLC 9W 840 4P G24q-3

Spectral Power Distribution Colour - CorePro LED PLC 9W 840 4P G24q-3

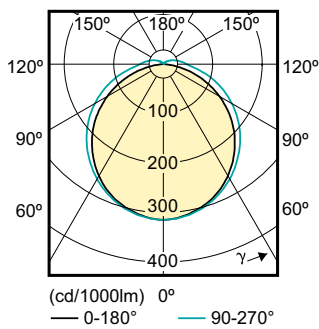

Light Distribution Diagram - CorePro LED PLC 9W 840 4P G24q-3

# CorePro LED PLC 4P

## Levensduur

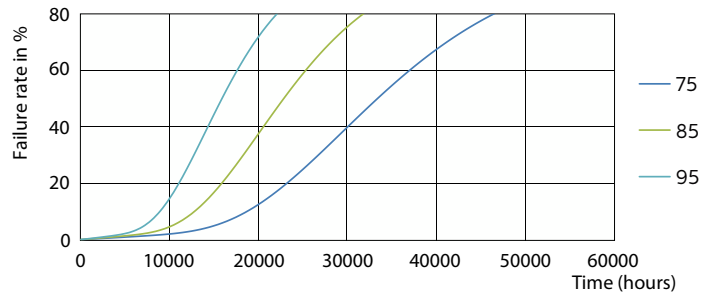
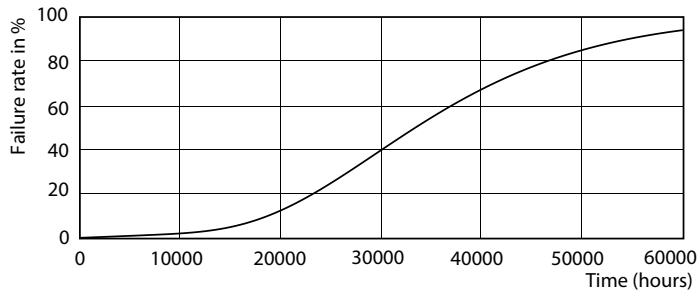

Life Expectancy Diagram - CorePro LED PLC 9W 840 4P G24q-3

Life Expectancy Diagram - CorePro LED PLC 9W 840 4P G24q-3

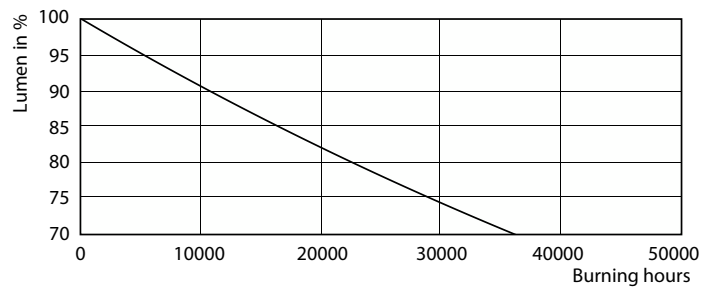
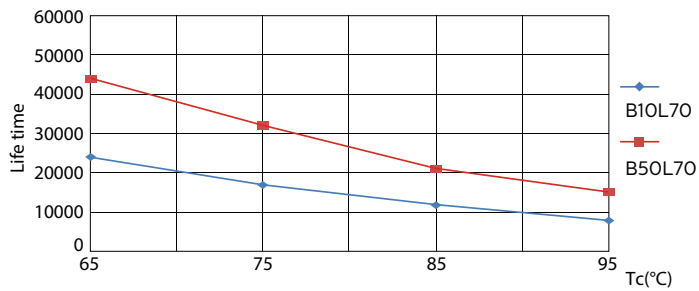

Life Expectancy Diagram - CorePro LED PLC 9W 840 4P G24q-3

Lumen Maintenance Diagram - CorePro LED PLC 9W 840 4P G24q-3

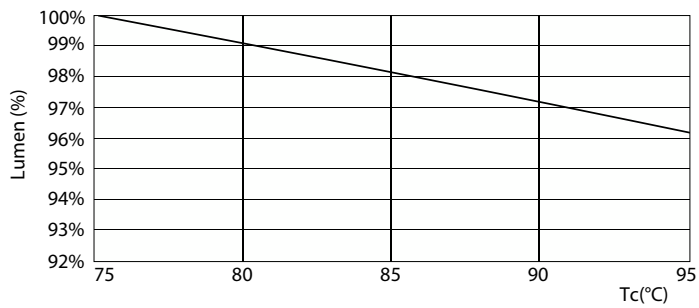

Lumen Maintenance Diagram - CorePro LED PLC 9W 840 4P G24q-3

## CorePro LED PLC 4P

