

Beacon 50W Mains Voltage - Hi-Spot ES50

BEACON ES50 S/C WHITE 240V
2041879

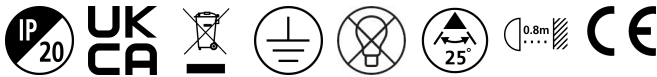

Product features



PRODUCT OVERVIEW

Product name	BEACON ES50 S/C WHITE 240V
Technology	LED/Halogen
Housing	Aluminium
Mount	Track mounting
Environment	Interior
General application	Hospitality, Museums & Galleries, Retail
ETIM Class	EC001744
E-number FI	4276121
E-number SE	7416257
E-number Norway	3223665
Warranty	5 years
LOR (%)	87
Light colour	N/A
Beam Angle (°)	25
Electrical protection	Class I
Housing colour	White
IP rating	IP20
Product EAN number	5025768418794
Light source included	N/A - Not Applicable

DATA TABLE

General data

Product name	BEACON ES50 S/C WHITE 240V
Technology	LED/Halogen
Housing	Aluminium
Mount	Track mounting
Environment	Interior
General application	Hospitality, Museums & Galleries, Retail

Beacon 50W Mains Voltage - Hi-Spot ES50

BEACON ES50 S/C WHITE 240V
2041879

ETIM Class	EC001744
E-number FI	4276121
E-number SE	7416257
E-number Norway	3223665
Warranty	5 years

Optical data

LOR (%)	87
Light colour	N/A
Adjustable chromaticity	N
Beam Angle (°)	25
Distribution type	Adjustable

Electrical data

Mains voltage (V)	230V
Electrical protection	Class I
Transformer required	No

Physical data

Housing colour	White
IP rating	IP20
Nominal Product Width (mm)	85
Nominal Product Height (mm)	114
Nominal Product Diameter (mm)	58
Max. Lamp Diameter (mm) - D	58
Weight (kg)	0.31

Packaging

Single packaging type	Carton
Product EAN number	5025768418794
Packaging single length / height (cm)	17.5
Packaging single width (cm)	15.0
Packaging single depth (cm)	17.5
Units per outer package	1
Packaging outer length / height (cm)	17.5
Packaging outer width (cm)	15.0
Packaging outer depth (cm)	17.5

PHOTOMETRY

Beacon 50W Mains Voltage - Hi-Spot ES50 BEACON ES50 S/C WHITE 240V 2041879

25°

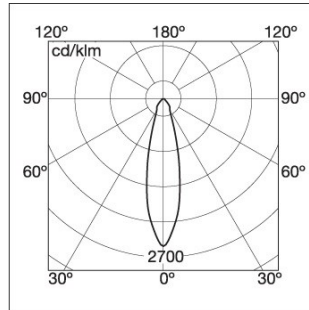
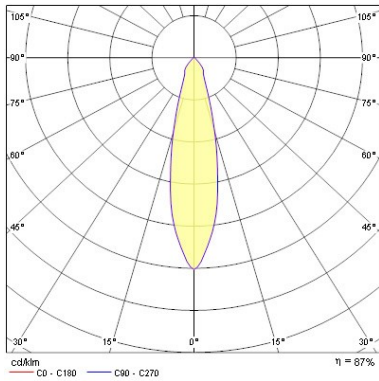
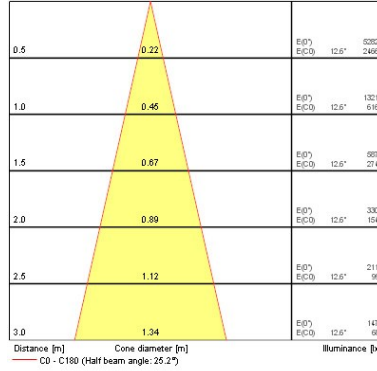
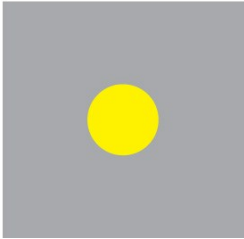

50W 25° lamp

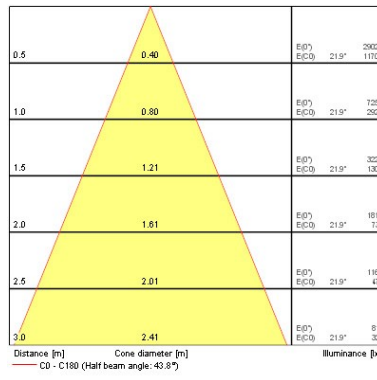
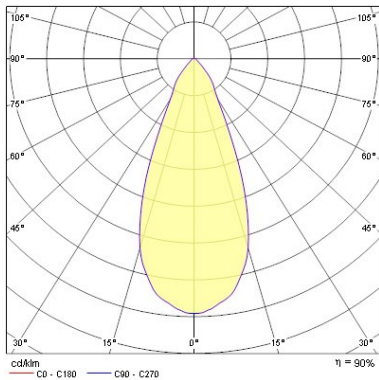
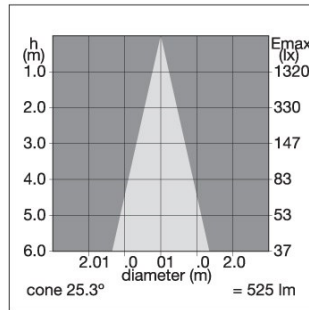

TECHNICAL DRAWINGS

Beacon 50W Mains Voltage - Hi-Spot ES50

BEACON ES50 S/C WHITE 240V
2041879

