



Sample image



Datasheet

Article number: 70016631



Designation: KG20.T103/33.KS51V

Description: Switch Global Disconnecter

IEC 60947-3 EN 60947-3, VDE 0660 Teil 107							
Tension assignée d'isolement Ui							
			<i>Tension (V) AC / DC</i>				
			690 AC				
Courant ininterrompu et thermique conventionnel Iu/Ith							
<i>Intensité (A)</i>		<i>Température Ambiante (°)</i>		<i>Température Maxi (°) Spécification complémentaire</i>			
25		50		55 Température ambiante +50°C durant 24 heures avec point à +55°C			
Courant assigné d'emploi Ie							
<i>Catégorie d'emploi</i>			<i>Tension (V)</i>		<i>Intensité (A)</i>		
AC-32A			20 - 400		20		
Puissance assignée d'emploi							
<i>Catégorie d'emploi</i>		<i>Tension (V)</i>		<i>Nb de phases</i>		<i>Nb de pôles</i>	
AC-3		220 - 240		3		3	
AC-3		380 - 440		3		3	
AC-3		660 - 690		3		3	
AC-23A		220 - 240		3		3	
AC-23A		380 - 440		3		3	
AC-23A		660 - 690		3		3	
Protection par fusible (IEC)							
<i>Caractéristique</i>			<i>Nombre de fusible</i>		<i>Intensité (A)</i>		
gG			1		35		
UL60947-4-1 , UL508							
Nominal Voltage							
			<i>Tension (V) AC / DC</i>				
			600 AC				
Tension assignée d'isolement Ui							
			<i>Tension (V) AC / DC</i>				
			600 AC				
Rated thermal current							
<i>Intensité (A)</i>		<i>Température Ambiante (°)</i>		<i>Additional Text</i>			
25		0 - 40		-			
Horsepower rating							
<i>Across-the-Line Motor Starting</i>		<i>Tension (V)</i>		<i>Nb de phases</i>		<i>Nb de pôles</i>	
DOL		110 - 120		1		2	
DOL		220 - 240		1		2	
DOL		277 - 277		1		2	
DOL		415 - 415		1		2	
DOL		440 - 480		1		2	
DOL		550 - 600		1		2	
DOL		110 - 120		3		3	
DOL		200 - 240		3		3	
DOL		415 - 415		3		3	
DOL		440 - 480		3		3	
DOL		550 - 600		3		3	
DOL		110 - 120		3		3	
DOL		200 - 240		3		3	
DOL		415 - 415		3		3	
DOL		440 - 480		3		3	
DOL		550 - 600		3		3	
Pilot duty rating code							
<i>Duty Code</i>							
A600							
SCCR / Max. fuse rating							
<i>Conditions of acceptability</i>							
This device is suitable for use on circuits capable of delivering not more than 10kA rms symmetrical amperes, 600V ac max. when protected by Type RK1 fuses.							
Suitable for use on a circuit capable of delivering not more than 65000 rms symmetrical amperes at 600V max., when protected by 40A Class J fuses.							
Temp. rating of wire							
<i>Temperature rating (°C)</i>			<i>Intensité (A) Text</i>				
60 - 75			-- --				
General Use							
<i>AC / DC</i>		<i>Tension (V)</i>		<i>Intensité (A)</i>		<i>Nb de phases</i>	
AC		277		25		1	
AC		600		25		1	
				<i>Nb de pôles</i>		<i>No. of contacts in series</i>	
				1		1	
				2		1	

General Use					
AC / DC	Tension (V)	Intensité (A)	Nb de phases	Nb de pôles	No. of contacts in series
AC	600	25	3	3	1
General Information					
Text					
- The operating handle and position indicating means to be used with these manual motor controllers should be provided from the manufacturer, or the operating handle and position indicating means to be used should have been previously evaluated in combination with the manual motor controllers.					
- When intended for use as a motor disconnecter the device shall be provided with a method of being locked in the OFF-position.					
CSA					
Nominal Voltage					
Tension (V) AC / DC					
600 AC					
Tension assignée d'isolement Ui					
Tension (V) AC / DC					
600 AC					
Rated thermal current					
Intensité (A)					
25					
Température Ambiante (°) Additional Text					
0 - 40 -					
Horsepower rating					
Across-the-Line Motor Starting	Tension (V)	Nb de phases	Nb de pôles	Power (HP)	Ambient temperature [°C]
DOL	110 - 120	1	2	1	40
DOL	220 - 240	1	2	3	40
DOL	277 - 277	1	2	3	40
DOL	415 - 415	1	2	5	40
DOL	440 - 480	1	2	5	40
DOL	550 - 600	1	2	5	40
DOL	110 - 120	3	3	2	40
DOL	220 - 240	3	3	7,50	40
DOL	415 - 415	3	3	10	40
DOL	440 - 480	3	3	15	40
DOL	550 - 600	3	3	20	40
Pilot duty rating code					
Duty Code					
A600					
Temp. rating of wire					
Temperature rating (°C)					
75					
Intensité (A) Text					
-- --					
General Use					
AC / DC	Tension (V)	Intensité (A)	Nb de phases	Nb de pôles	No. of contacts in series
AC	277	25	1	1	1
AC	600	25	1	2	1
AC	600	25	3	3	1
GENERAL TECHNICAL INFORMATION					
Size of conductor					
composition of conductor	Min. / Max. value	No. of conductor per terminal	Cross section (mm ²) or (AWG/kcmil)	Material of the wire	
solid wire	Min.	1	0,75mm ²	Copper	
solid wire	Min.	2	0,5mm ²	Copper	
flexible wire	Min.	2	0,75mm ²	Copper	
flexible wire	Max.	1	AWG 10	Copper	
flexible wire	Max.	1	4mm ²	Copper	
flexible wire	Min.	1	1,5mm ²	Copper	
Single-core or stranded wire	Max.	1	6mm ²	Copper	
Single-core or stranded wire	Max.	1	AWG 10	Copper	
flexible wire with sleeve	Max.	1	4mm ²	Copper	
flexible wire with ferrule according to DIN 46228	Min.	1	0,75mm ²	Copper	
flexible wire with ferrule according to DIN 46228	Min.	2	0,5mm ²	Copper	
Stripping length					
Length (mm) --					
					
Recommandations concernant le tournevis					
Type	Value				
Tournevis cruciforme	PH2				
Slot screwdriver according to DIN 5264	0,8x4				
Tightening torque of screws					
tightening torque (Nm)					
1,25					
tightening torque (lb-in)					
11					
Approbations					
Specification	Marking				
EAC					
CE marking					
UK Directives					

Approbations

Specification	Marking
CSA C.22.2 No.14	
GB/T14048.3	

General Information

Text

- EMC Note: This device is suitable for use in environment A and B.
- Ne jamais lubrifier ou traiter les contacts.
- Les commutateurs ne peuvent être montés, branchés et mis en service que par une personne qualifiée selon les règles techniques en vigueur.
- Use copper wire only. Do not coat the wire end with tin.
- Les bornes qui ne sont pas supposées être utilisées pour le raccordement de l'appareil sont livrées serrées et ne doivent pas être desserrées. Si toutefois ces bornes sont malgré tout ouvertes accidentellement, vérifier qu'aucun shunt n'est manquant. Le câblage terminé, s'assurer que toutes les bornes sont serrées.

Waste Electrical & Electronic Equipment (WEEE)

Picture name	Description
	Do not throw in the trash as care must be taken to ensure environmentally sound disposal and recycling. Please either use an environmentally friendly waste disposal company; return to the supplier for disposal; or return direct to the manufacturer, Kraus & Naimer. You can find local Kraus & Naimer offices at www.krausnaimer.com

Proposition 65

Picture name	Description
	WARNING: This product can expose you to chemicals including nickel and lead, which is known to the State of California to cause cancer. For more information go to www.P65Warnings.ca.gov .

Type de contacts: Rigid contact bridge
Revêtement des Contacts: Silver
Types de raccordement: Screw terminal

Mounting-KS51V

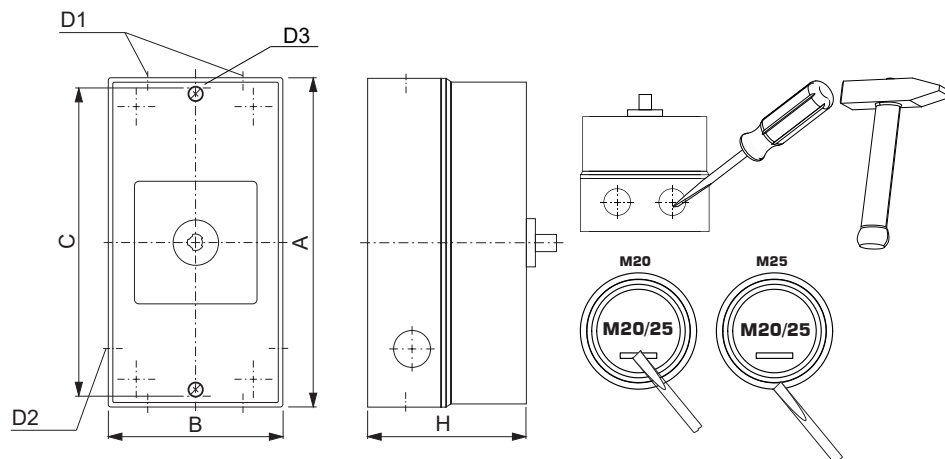

IP - Code front side	IP66, IP67, IP69k
Stages	1,00 - 5,00
A	H 121,00 mm
B	H 86,00 mm
C	H 110,00 mm
D1	Ø 4,00 x M20/M25
D2	Ø 2,00 x M20
D3	Ø 4,20 mm
H	H 90,00 mm

Wiring diagram

KG20.T303.KS51V

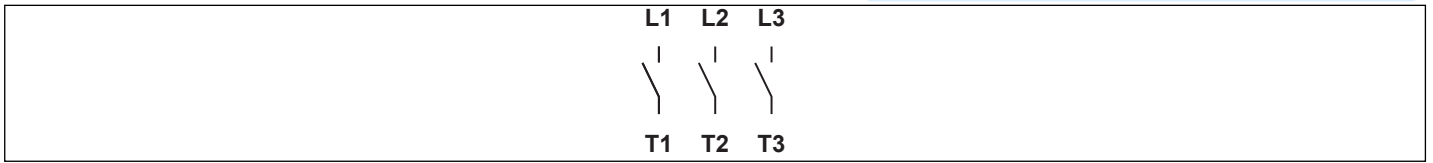

Face plate

S1.F656/C10.V9

