







Sample image

## Datasheet

**Article number:** 70003124  
**Designation:** CA10.A293.EF  
**Description:** Switch

<b>IEC 60947-3 EN 60947-3, VDE 0660 Teil 107</b>						
<b>Tension assignée d'isolement Ui</b>						
<i>Tension (V) AC / DC</i>						
690 AC / DC						
<b>Tension assignée de tenue aux chocs Uimp</b>						
<i>Tension (kV) Classe de protection surcharges Degré de pollution Type d'alimentation Fonction</i>						
4 III 3 Valable pour un réseau triphasé avec le neutre à la terre Switch disconnector						
<b>Courant ininterrompu et thermique conventionnel Iu/Ith</b>						
<i>Intensité (A) Température Ambiante (°) Température Maxi (°) Spécification complémentaire</i>						
20 55 60 Température ambiante +55°C durant 24 heures avec point à +60°C						
<b>Courant assigné d'emploi Ie</b>						
<i>Catégorie d'emploi Tension (V) Intensité (A)</i>						
AC-15 220 - 240 6						
AC-15 380 - 440 4						
<b>Puissance assignée d'emploi</b>						
<i>Catégorie d'emploi Tension (V) Nb de phases Nb de pôles Puissance (kW)</i>						
AC-3 220 - 240 3 3 3						
AC-3 380 - 440 3 3 5,50						
AC-3 660 - 690 3 3 5,50						
AC-3 220 - 240 1 2 2,20						
AC-3 380 - 440 1 2 3						
AC-23A 220 - 240 3 3 3,70						
AC-23A 380 - 440 3 3 7,50						
AC-23A 660 - 690 3 3 7,50						
AC-23A 220 - 240 1 2 2,50						
AC-23A 380 - 440 1 2 3,70						
<b>Protection par fusible (IEC)</b>						
<i>Caractéri Nombre de fusible Intensité (A)</i>						
gG 1 25						
<b>UL60947-4-1 , UL508</b>						
<b>Nominal Voltage</b>						
<i>Tension (V) AC / DC</i>						
300 AC / DC						
<b>Tension assignée d'isolement Ui</b>						
<i>Tension (V) AC / DC</i>						
300 AC						
<b>Rated thermal current</b>						
<i>Intensité (A) Température Ambiante (°) Additional Text</i>						
20 0 - 40 --						
<b>Horsepower rating</b>						
<i>Across-the-Line Motor Starting Tension (V) Nb de phases Nb de pôles Power (HP) Ambient temperature [°C]</i>						
Reversing 110 - 120 1 2 0,17 40						
Reversing 220 - 240 1 2 0,50 40						
Reversing 277 - 277 1 2 0,60 40						
Reversing 110 - 120 3 3 0,50 40						
Reversing 220 - 240 3 3 1 40						
DOL 110 - 120 1 2 0,50 40						
DOL 220 - 240 1 2 1 40						
DOL 277 - 277 1 2 2 40						
DOL 110 - 120 3 3 1,50 40						
DOL 220 - 240 3 3 3 40						
<b>Pilot duty rating code</b>						
<i>Duty Code</i>						
A300						
<b>SCCR / Max. fuse rating</b>						
<i>Conditions of acceptability</i>						
These devices are suitable for use on circuits capable of delivering not more than 5000 rms symmetrical amperes, 600V ac max. when protected by Class RK1 fuses. Manual Motor Controllers when intended for use as a motor disconnectors are suitable for use on a circuit capable of delivering not more than 5000 rms symmetrical amperes, 600V ac max. when protected by 30A Class J time delay fuses.						
<b>Temp. rating of wire</b>						
<i>Temperature rating (°C) Intensité (A) Text</i>						
60 - 75 -- Use copper wire only						

Connecting instructions						
<b>Markings</b>						
When intended for use as a motor disconnecter the device shall be provided with a method of being locked in the OFF-position.						
<b>General Use</b>						
AC / DC	Tension (V)	Intensité (A)	Nb de phases	Nb de pôles	No. of contacts in series	
AC	300	20	1	2	1	
AC	300	20	3	3	1	
<b>CSA</b>						
<b>Nominal Voltage</b>						
				Tension (V)	AC / DC	
				300 AC		
<b>Tension assignée d'isolement Ui</b>						
				Tension (V)	AC / DC	
				300 AC		
<b>Rated thermal current</b>						
		Intensité (A)	Température Ambiante (°)		Additional Text	
		20	0 - 40		-	
<b>Horsepower rating</b>						
<i>Across-the-Line Motor Starting</i>						
	Tension (V)	Nb de phases	Nb de pôles	Power (HP)	Ambient temperature [°C]	
DOL	110 - 120	1	2	0,50	40	
DOL	220 - 240	1	2	1	40	
DOL	277 - 277	1	2	2	40	
DOL	110 - 120	3	3	1,50	40	
DOL	220 - 240	3	3	3	40	
<b>Pilot duty rating code</b>						
<i>Duty Code</i>						
A300						
<b>Temp. rating of wire</b>						
			Temperature rating (°C)	Intensité (A) Text		
			75	- only		
<b>General Use</b>						
AC / DC	Tension (V)	Intensité (A)	Nb de phases	Nb de pôles	No. of contacts in series	
AC	300	20	1	1	1	
<b>GENERAL TECHNICAL INFORMATION</b>						
<b>Tightening torque of screws</b>						
				tightening torque (Nm)	tightening torque (lb-in)	
				0,60	5	
<b>Stripping length</b>						
				Length (mm) -	8 STRIPPINGLENGTH	
<b>Size of conductor</b>						
composition of conductor	Min. / Max. value	No. of conductor per terminal		Cross section (mm <sup>2</sup> ) or (AWG/kcmil)	Material of the wire	
solid wire	Min.	1		0,5mm <sup>2</sup>	Copper	
solid wire	Min.	2		0,5mm <sup>2</sup>	Copper	
flexible wire	Min.	1		0,75mm <sup>2</sup>	Copper	
flexible wire	Min.	2		0,75mm <sup>2</sup>	Copper	
flexible wire	Max.	2		2,5mm <sup>2</sup>	Copper	
flexible wire	Max.	2		AWG 14	Copper	
Single-core or stranded wire	Max.	2		AWG 12	Copper	
Single-core or stranded wire	Max.	2		2,5mm <sup>2</sup>	Copper	
flexible wire with ferrule according to DIN 46228	Min.	1		0,5mm <sup>2</sup>	Copper	
flexible wire with ferrule according to DIN 46228	Max.	2		2,5mm <sup>2</sup>	Copper	
flexible wire with ferrule according to DIN 46228	Min.	2		0,5mm <sup>2</sup>	Copper	
<b>Approbations</b>						
<i>Specification</i>						<i>Marking</i>
EAC						
CE marking						
UK Directives						
CSA C.22.2 No.14						
GB/T14048.3						
<b>Recommandations concernant le tournevis</b>						
<i>Type</i>			<i>Value</i>			
Tournevis cruciforme			PH1			
Slot screwdriver according to DIN 5264			0,8x4			
<b>General Information</b>						
<i>Text</i>						
- Ne jamais lubrifier ou traiter les contacts.						
- Les commutateurs ne peuvent être montés, branchés et mis en service que par une personne qualifiée selon les règles techniques en vigueur.						

## General Information

### Text

- Use copper wire only. Do not coat the wire end with tin.

- Les bornes qui ne sont pas supposées être utilisées pour le raccordement de l'appareil sont livrées serrées et ne doivent pas être desserrées. Si toutefois ces bornes sont malgré tout ouvertes accidentellement, vérifier qu'aucun shunt n'est manquant. Le câblage terminé, s'assurer que toutes les bornes sont serrées.

- Après mise en place des les commutateurs l'espace entre bornes doit être suffisant pour répondre aux exigences des normes en vigueur.

### Waste Electrical & Electronic Equipment (WEEE)

Picture name Description



Do not throw in the trash as care must be taken to ensure environmentally sound disposal and recycling. Please either use an environmentally friendly waste disposal company; return to the supplier for disposal; or return direct to the manufacturer, Kraus & Naimer. You can find local Kraus & Naimer offices at [www.krausnaimer.com](http://www.krausnaimer.com)

### Proposition 65

Picture name Description



WARNING: This product can expose you to chemicals including nickel and lead, which is known to the State of California to cause cancer. For more information go to [www.P65Warnings.ca.gov](http://www.P65Warnings.ca.gov).

Type de contacts: Rigid contact bridge

Revêtement des Contacts: Silver

Types de raccordement: Screw terminal

## Fixation-EF

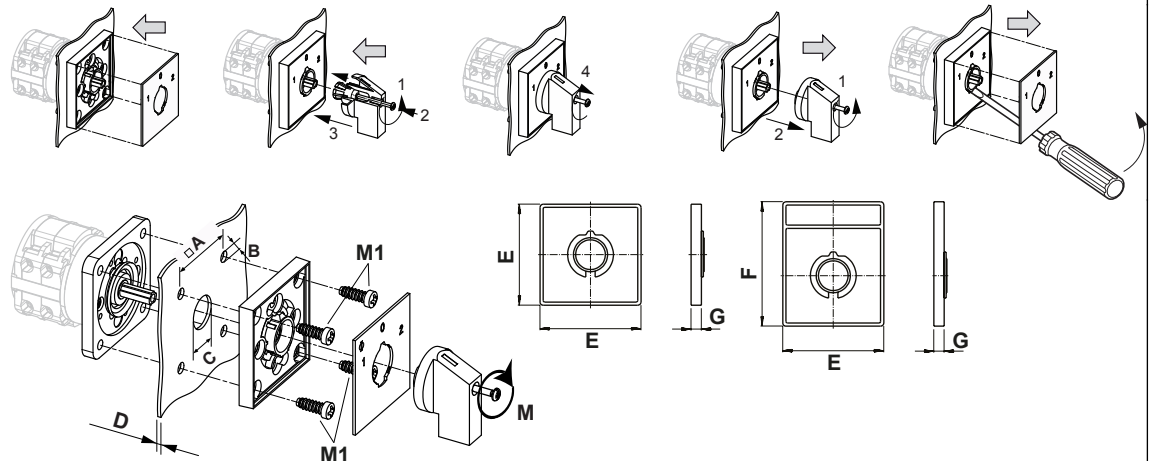

IP - Code front side		IP66, IP67, IP69k
Stages		1,00 - 12,00
A	□	36,00 mm
B	∅	5,00 mm
C	∅	15,00 - 19,00 mm
D	H	<= 4,00 mm
E	H	48,00 mm
F	H	59,00 mm
G	H	6,70 mm
M	$\vec{M}$	0,50 Nm
M1	$\vec{M}$	0,90 Nm

## Wiring diagram

CA10.A293.EF

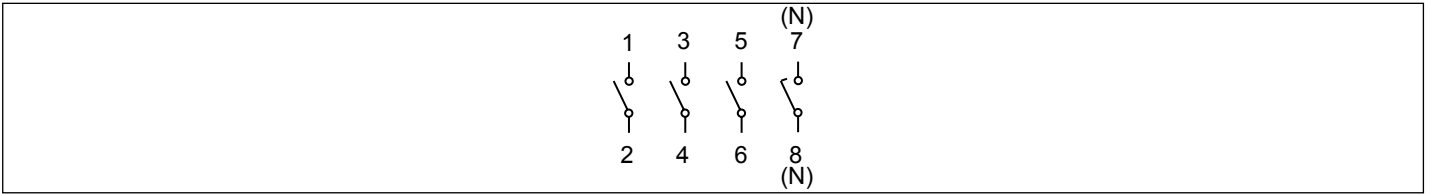

**Switch program**

CA10.A293.EF

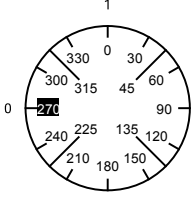
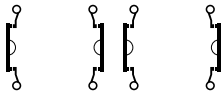
 Kraus & Naimer		<b>CA10</b>	<b>A293</b>	<b>Page 1 of 1</b>											
<b>Face Plate</b>															
		1	3	5	7	9	11	13	15	17	19	21	23		
															
Switching Angle <input type="text" value="90"/> Total switching Angle <input type="text" value="90"/>		2	4	6	8	10	12	14	16	18	20	22	24		
0	270														
	285														
	300														
	315														
	330														
	345														
1	0														
	15														
	30														
	45														
	60														
	75														
	90														
	105														
	120														
	135														
	150														
	165														
	180														
	195														
	210														
	225														
	240														
	255														

Version: 87

**Face plate**

S0.F056/A1B.PEL

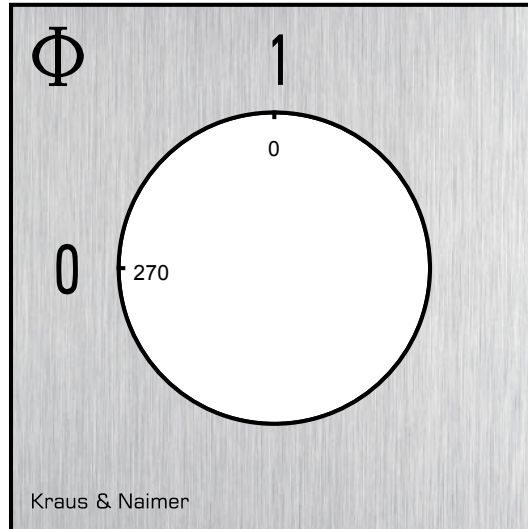

## HANDLES

**Designation:** S0C.G251  
**Handle colour:** "1" black

