



Sample image





## Datasheet

**Article number:** 70024035

**Designation:** KG20.T203/33.KL51V

**Description:** Switch Global Disconnecter

<b>IEC 60947-3 EN 60947-3, VDE 0660 Teil 107</b>						
<b>Tension assignée d'isolement Ui</b>						
			<i>Tension (V) AC / DC</i>			
			690 AC			
<b>Courant ininterrompu et thermique conventionnel Iu/Ith</b>						
<i>Intensité (A)</i>	<i>Température Ambiante (°)</i>	<i>Température Maxi (°)</i>	<i>Spécification complémentaire</i>			
25	50	55	Température ambiante +50°C durant 24 heures avec point à +55°C			
<b>Courant assigné d'emploi Ie</b>						
<i>Catégorie d'emploi</i>			<i>Tension (V)</i>		<i>Intensité (A)</i>	
AC-32A			20 - 400		20	
<b>Puissance assignée d'emploi</b>						
<i>Catégorie d'emploi</i>	<i>Tension (V)</i>	<i>Nb de phases</i>	<i>Nb de pôles</i>	<i>Puissance (kW)</i>		
AC-3	220 - 240	3	3	4		
AC-3	380 - 440	3	3	5,50		
AC-3	660 - 690	3	3	5,50		
AC-23A	220 - 240	3	3	5,50		
AC-23A	380 - 440	3	3	7,50		
AC-23A	660 - 690	3	3	7,50		
<b>Protection par fusible (IEC)</b>						
<i>Caractéristique</i>			<i>Nombre de fusible</i>		<i>Intensité (A)</i>	
gG			1		35	
<b>UL60947-4-1 , UL508</b>						
<b>Nominal Voltage</b>						
			<i>Tension (V) AC / DC</i>			
			600 AC			
<b>Tension assignée d'isolement Ui</b>						
			<i>Tension (V) AC / DC</i>			
			600 AC			
<b>Rated thermal current</b>						
		<i>Intensité (A)</i>	<i>Température Ambiante (°)</i>	<i>Additional Text</i>		
		25	0 - 40	-		
<b>Horsepower rating</b>						
<i>Across-the-Line Motor Starting</i>	<i>Tension (V)</i>	<i>Nb de phases</i>	<i>Nb de pôles</i>	<i>Power (HP)</i>	<i>Ambient temperature [°C]</i>	
DOL	110 - 120	1	2	1	40	
DOL	220 - 240	1	2	3	40	
DOL	277 - 277	1	2	3	40	
DOL	415 - 415	1	2	5	40	
DOL	440 - 480	1	2	5	40	
DOL	550 - 600	1	2	5	40	
DOL	110 - 120	3	3	2	40	
DOL	200 - 240	3	3	7,50	40	
DOL	415 - 415	3	3	10	40	
DOL	440 - 480	3	3	15	40	
DOL	550 - 600	3	3	20	40	
<b>Pilot duty rating code</b>						
<i>Duty Code</i>						
A600						
<b>SCCR / Max. fuse rating</b>						
<i>Conditions of acceptability</i>						
This device is suitable for use on circuits capable of delivering not more than 10kA rms symmetrical amperes, 600V ac max. when protected by Type RK1 fuses.						
Suitable for use on a circuit capable of delivering not more than 65000 rms symmetrical amperes at 600V max., when protected by 40A Class J fuses.						
<b>Temp. rating of wire</b>						
			<i>Temperature rating (°C)</i>	<i>Intensité (A)</i>	<i>Text</i>	
			60 - 75	--	--	
<b>General Use</b>						
<i>AC / DC</i>	<i>Tension (V)</i>	<i>Intensité (A)</i>	<i>Nb de phases</i>	<i>Nb de pôles</i>	<i>No. of contacts in series</i>	
AC	277	25	1	1	1	
AC	600	25	1	2	1	

General Use					
AC / DC	Tension (V)	Intensité (A)	Nb de phases	Nb de pôles	No. of contacts in series
AC	600	25	3	3	1
General Information					
Text					
- The operating handle and position indicating means to be used with these manual motor controllers should be provided from the manufacturer, or the operating handle and position indicating means to be used should have been previously evaluated in combination with the manual motor controllers.					
- When intended for use as a motor disconnecter the device shall be provided with a method of being locked in the OFF-position.					
CSA					
Nominal Voltage					
			Tension (V) AC / DC		
			600 AC		
Tension assignée d'isolement Ui					
			Tension (V) AC / DC		
			600 AC		
Rated thermal current					
		Intensité (A)	Température Ambiante (°C)		Additional Text
		25	0 - 40		-
Horsepower rating					
Across-the-Line Motor Starting					
	Tension (V)	Nb de phases	Nb de pôles	Power (HP)	Ambient temperature [°C]
DOL	110 - 120	1	2	1	40
DOL	220 - 240	1	2	3	40
DOL	277 - 277	1	2	3	40
DOL	415 - 415	1	2	5	40
DOL	440 - 480	1	2	5	40
DOL	550 - 600	1	2	5	40
DOL	110 - 120	3	3	2	40
DOL	220 - 240	3	3	7,50	40
DOL	415 - 415	3	3	10	40
DOL	440 - 480	3	3	15	40
DOL	550 - 600	3	3	20	40
Pilot duty rating code					
Duty Code					
A600					
Temp. rating of wire					
			Temperature rating (°C)	Intensité (A)	Text
			75	--	--
General Use					
AC / DC	Tension (V)	Intensité (A)	Nb de phases	Nb de pôles	No. of contacts in series
AC	277	25	1	1	1
AC	600	25	1	2	1
AC	600	25	3	3	1
GENERAL TECHNICAL INFORMATION					
Tightening torque of screws					
			tightening torque (Nm)	tightening torque (lb-in)	
			1,25	11	
Stripping length					
			Length (mm)	-	
			9	STRIPPINGLENGTH	
Size of conductor					
composition of conductor	Min. / Max. value	No. of conductor per terminal	Cross section (mm <sup>2</sup> ) or (AWG/kcmil)		Material of the wire
solid wire	Min.	1	0,75mm <sup>2</sup>		Copper
solid wire	Min.	2	0,5mm <sup>2</sup>		Copper
flexible wire	Min.	2	0,75mm <sup>2</sup>		Copper
flexible wire	Max.	1	AWG 10		Copper
flexible wire	Max.	1	4mm <sup>2</sup>		Copper
flexible wire	Min.	1	1,5mm <sup>2</sup>		Copper
Single-core or stranded wire	Max.	1	6mm <sup>2</sup>		Copper
Single-core or stranded wire	Max.	1	AWG 10		Copper
flexible wire with sleeve	Max.	1	4mm <sup>2</sup>		Copper
flexible wire with ferrule according to DIN 46228	Min.	1	0,75mm <sup>2</sup>		Copper
flexible wire with ferrule according to DIN 46228	Min.	2	0,5mm <sup>2</sup>		Copper
Approbations					
Specification					Marking
EAC					
CE marking					
UK Directives					
CSA C.22.2 No.14					
GB/T14048.3					

### Recommandations concernant le tournevis

Type	Value
Tournevis cruciforme	PH2
Slot screwdriver according to DIN 5264	0,8x4

### General Information

**Text**

- EMC Note: This device is suitable for use in environment A and B.
- Ne jamais lubrifier ou traiter les contacts.
- Les commutateurs ne peuvent être montés, branchés et mis en service que par une personne qualifiée selon les règles techniques en vigueur.
- Use copper wire only. Do not coat the wire end with tin.
- Les bornes qui ne sont pas supposées être utilisées pour le raccordement de l'appareil sont livrées serrées et ne doivent pas être desserrées. Si toutefois ces bornes sont malgré tout ouvertes accidentellement, vérifier qu'aucun shunt n'est manquant. Le câblage terminé, s'assurer que toutes les bornes sont serrées.

### Waste Electrical & Electronic Equipment (WEEE)

Picture name	Description
	Do not throw in the trash as care must be taken to ensure environmentally sound disposal and recycling. Please either use an environmentally friendly waste disposal company; return to the supplier for disposal; or return direct to the manufacturer, Kraus & Naimer. You can find local Kraus & Naimer offices at <a href="http://www.krausnaimer.com">www.krausnaimer.com</a>

### Proposition 65

Picture name	Description
	WARNING: This product can expose you to chemicals including nickel and lead, which is known to the State of California to cause cancer. For more information go to <a href="http://www.P65Warnings.ca.gov">www.P65Warnings.ca.gov</a> .

Type de contacts: Rigid contact bridge

Revêtement des Contacts: Silver

Types de raccordement: Screw terminal

### Mounting-KL51V

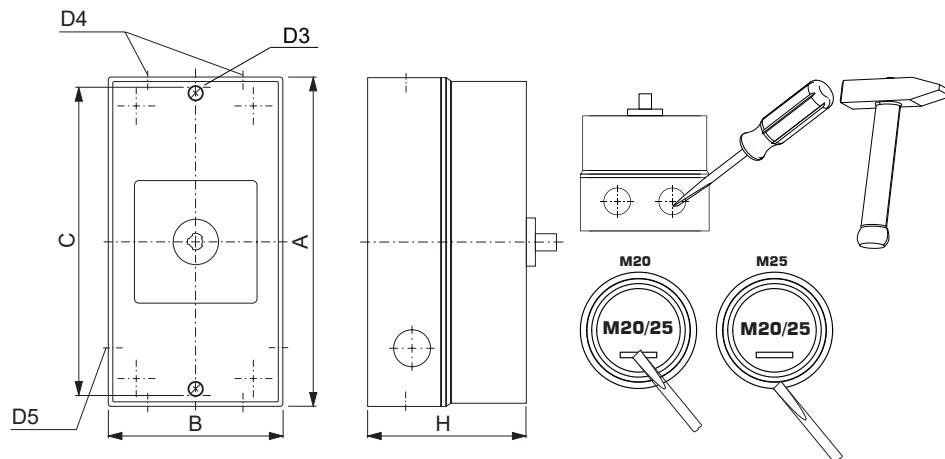

IP - Code front side	IP66, IP67, IP69k
Stages	1,00 - 5,00
A	H 160,00 mm
B	H 85,00 mm
C	H 150,00 mm
D3	Ø 4,20 mm
D4	Ø 4,00 x M20/M25
D5	Ø 2,00 x M20
H	H 82,00 mm

**Wiring diagram**

KG20.T303.KL51V

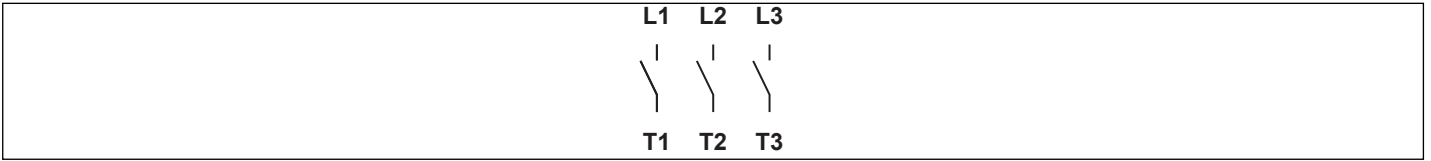



**Face plate**

S1.F656/E10.V9

