

**Retrofit
Replacement / Re-
novation / Moderni-
sation**

Water applications checklist

Effortless upgrades with retrofit solutions from Belimo



The reasons why a plant needs to be retrofitted or modernised vary. Often it is a question of prolonging the service life of a plant or rather enhancing its quality and efficiency. Sooner or later for these reasons, components will need to be replaced .

The universal butterfly valves and globe valve actuators from Belimo are ideally suited for enabling the desired modernisation and a maximum amount of automation in an existing plant.

The actuators can be easily mounted directly or using simple adapters on installed butterfly valves and globe valves from different manufacturers.

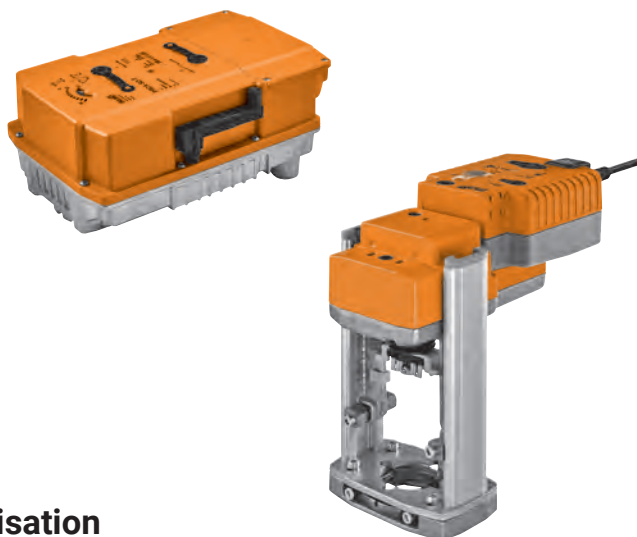

Retrofit

Replacement / Renovation / Modernisation

Water

Actuators for third-party globe valves	Belimo Retrofit App or checklist	4
Mechanical accessories for globe valves	Adapter kits and spacer rings	6
Actuators for third-party rotary valves and third-party butterfly valves	Belimo Retrofit App or checklist	7
	Form fit adapter for valve stem hexagonal / Two flats / Wedge groove	12
Mechanical accessories for butterfly valves	Reducer / Form-fit adapter, adapter kit for SY.., adapter kits for PR.. / PRK..	14
Electrical accessories for butterfly valves	Auxiliary switches, feedback potentiometer	15

Retrofit App

Easy to find the right replacement actuator or sensor for the modernisation of existing installations. Install the app via the "App Store" or "Google Play". With the QR Code you can get there directly.



Belimo Retrofit App or checklist

Belimo offers the right actuator solution for practically all valves and butterfly valves from other manufacturers and also covers a wide array of nominal diameters. The Belimo Retrofit App ([page 3](#)) is the quickest way to find out which valve types can be equipped and modernised with a Belimo actuator.

Perhaps you do not know the manufacturer and type of your valves? Then you simply find the right retrofit actuator using the following checklist. In just a few steps, you can then determine the dimensions and specifications required by your valve types. If you have any further questions, please get in touch with your local Belimo contact person.

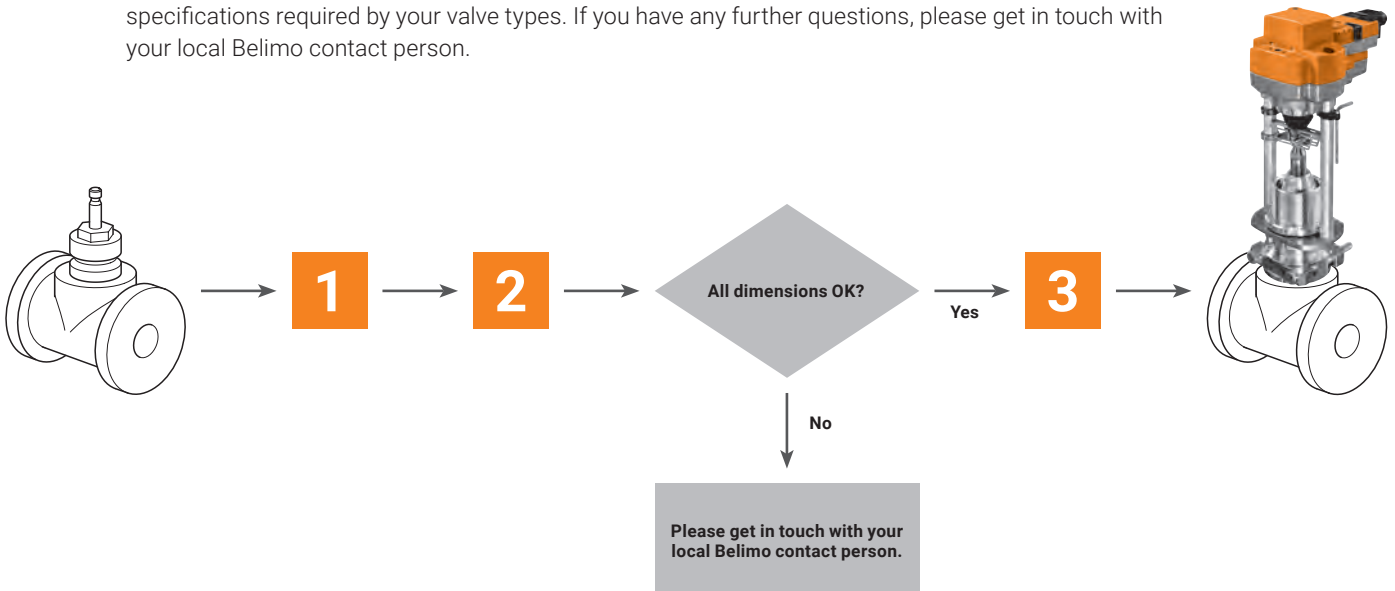

1

Dimensions checklist

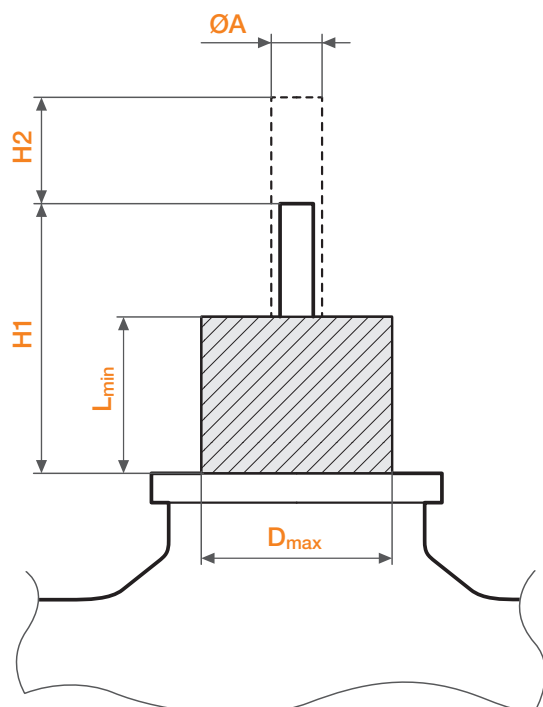

Tables for stems

C	M	M1	M2
		DN 15...50	DN 65...150
		M6	M8
		M8	M8x1.0
		M10	M10
		1/4" 28 UNF	M12x1.25
		1/4" 32 UNF	M16x1.5
		3/8" 28 UNF	1/4" 28 UNF
			1/4" 32 UNF
			3/8" 28 UNF
	7/16" 20 UNF		
	1/2" 20 UNF		

2

Check dimensions and determine actuating force

DN 15...50



Actuator family	D _{max} [mm]	L _{min} [mm]	H1 [mm]	H2 [mm]	ØA [mm]	C [mm]	M	Actuating force	DN 15	DN 25	DN 32	DN 40	DN 50	DN 65	DN 80
LV..								500 N	■	■	■	■	■		
NV.. / NVK..	≤45	≥15	≥42	5...20	5...12	>2.5	See M1	1000 N	■	■	■	■	■		
SV..								1500 N	■	■	■	■	■		
Values to be checked															

DN 65...150



Actuator family	D _{max} [mm]	L _{min} [mm]	H1 [mm]	H2 [mm]	ØA [mm]	C [mm]	M	Actuating force	DN 40	DN 50	DN 65	DN 80	DN 100	DN 125	DN 150
SVL..				5...50				1500 N	■	■	■	■	■		
AVK..	≤60	≥30	≥59	5...32	6...16	>3.5	See M2	2000 N	■	■	■	■	■	■	
EV..				5...50				2500 N			■	■	■	■	
RV..								4500 N			■	■	■	■	■
Values to be checked															

■ Recommended ■ Recommended under certain circumstances

3











Actuator selection

Actuator family	Actuator type	Actuating force	Nominal stroke	Actuating time per nominal stroke	Open/close	3-point	Modulating (2...10 V)	Communicative	Fail-safe	Nominal voltage AC/DC 24 V AC 230 V
Standard actuators										
LV..	LV24A-RE	500 N	20 mm	200 s	■	■				24 V
	LV230A-RE				■	■			230 V	
NV.. / NVK..	NV24A-RE	1000 N	20 mm	150 s	■	■				24 V
	NV230A-RE				■	■			230 V	
SV..	SV24A-RE	1500 N	20 mm	150 s	■	■				24 V
	SV230A-RE				■	■			230 V	
SVL..	SVL230A-RE		50 mm		■	■				230 V
EV..	EV24A-RE	2500 N	50 mm	188 s	■	■				24 V
	EV230A-RE				■	■			230 V	
Fail-safe actuators										
NV.. / NVK..	NVK24A-3-RE	1000 N	20 mm	150 s		■			■	AC 24 V
	NVK230A-3-RE					■		■	230 V	
AVK..	AVK24A-3-RE ¹⁾	2000 N	32 mm	150 s		■			■	AC 24 V
	AVK230A-3-RE ¹⁾					■		■	230 V	
Parametrisable actuators										
LV..	LV24A-MP-RE	500 N	20 mm	200 s			■	■		24 V
	NV24A-MP-RE			150 s			■	■		
NV.. / NVK..	NVC24A-MP-RE	1000 N	20 mm	35 s			■	■		24 V
	NVK24A-MP-RE			150 s			■	■	■	
	NVKC24A-MP-RE			35 s			■	■	■	
SV..	SV24A-MP-RE	1500 N	20 mm	150 s			■	■		
	SVC24A-MP-RE			35 s			■	■		24 V
SVL..	SVL24A-MP-RE		50 mm	150 s			■	■		
AVK..	AVK24A-MP-RE ¹⁾	2000 N	32 mm	150 s			■	■	■	24 V
EV..	EV24A-MP-RE	2500 N	50 mm	188 s			■	■		24 V
	EVC24A-MF-RE ²⁾			44 s			■	■		
RV..	RV24A-MF-RE ²⁾	4500 N	50 mm	150 s			■			24 V

¹⁾ Actuators AVK.. with maximum stroke 32 mm

²⁾ Multifunctional, parametrisable, non-bus-capable actuators

Adapter kits and spacer rings

		Suitable for actuator								
		LV..	NV..	NVK..	SV..	SVL..	AVK..	EV..	RV..	Type
	Adapter kit Siemens globe valve	■	■	■	■					ZNV-201
	Adapter kit Schneider/TAC globe valve	■	■	■	■	■				ZNV-202
	Adapter kit Danfoss	■	■	■	■	■				ZNV-205
	Adapter kit IMI / Elesta	■	■	■	■	■				ZNV-206
	Washer Sauter for Sauter, stroke 50 mm						■	■	■	ZRV-304
	Spacer ring for LDM, stroke 20 mm	■	■	■	■	■				ZNV-203
	Spacer ring for Sauter, stroke 20 mm	■	■	■	■	■				ZNV-204
	Spacer ring for Sauter, stroke 50 mm						■	■	■	ZRV-301
	Spacer ring for Siebe, stroke 50 mm						■	■	■	ZRV-302
	Spacer ring for Johnson Control, stroke 50 mm						■	■	■	ZRV-303

Belimo Retrofit App or checklist

Belimo offers the right actuator solution for practically all valves and butterfly valves from other manufacturers and also covers a wide array of nominal diameters. The Belimo Retrofit App (**page 3**) is the quickest way to find out which valve types can be equipped and modernised with a Belimo actuator.

Perhaps you do not know the manufacturer and type of your valves? Then you simply find the right retrofit actuator using the following checklist. In just a few steps, you can then determine the dimensions and specifications required by your valve types. If you have any further questions, please get in touch with your local Belimo contact person.

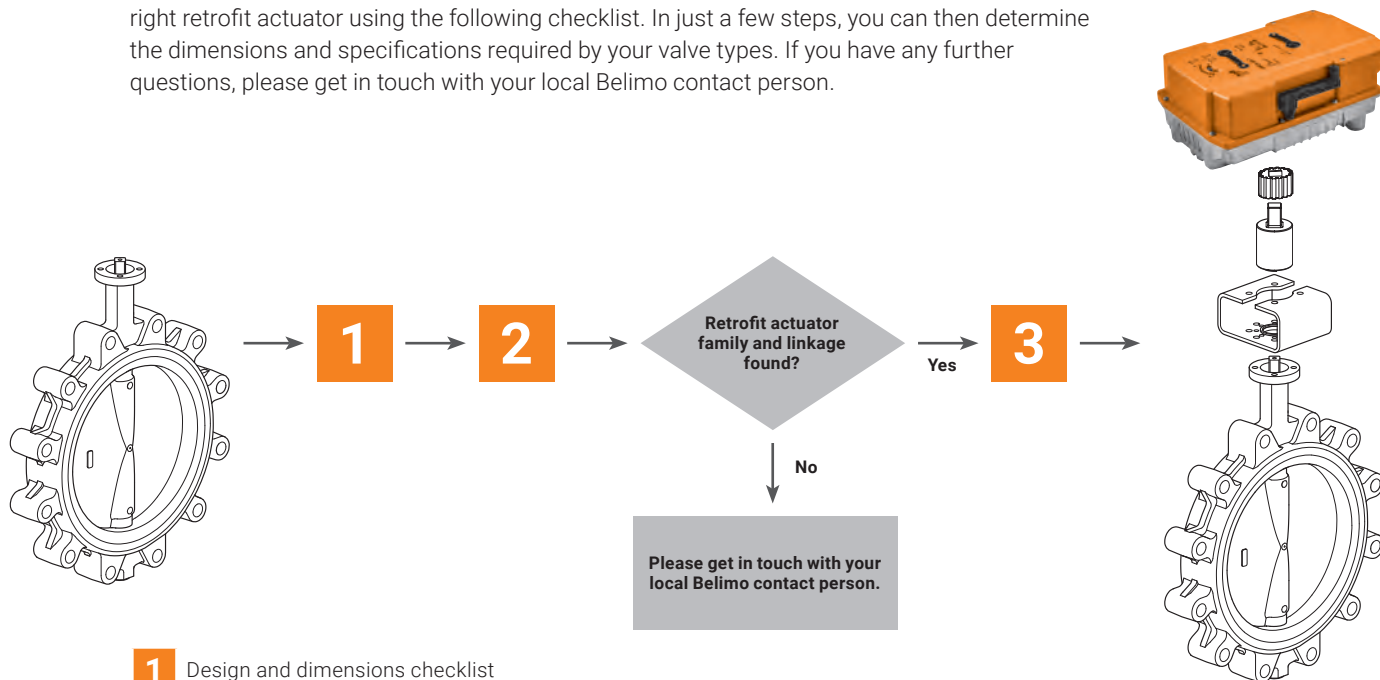

- 1** Design and dimensions checklist
- 2** Selection table of actuator family and linkages
- 3** Actuator selection

1 Design and dimensions checklist

F Flange

F04	= 42 mm
F05	= 50 mm
F07	= 70 mm
F10	= 102 mm

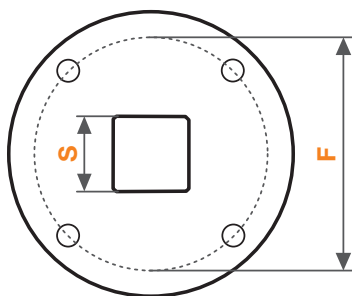

Square Selection table **page 8**

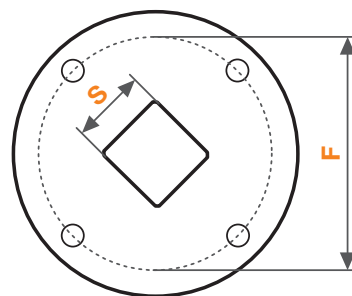

Square 45° rotated Selection table **page 9**

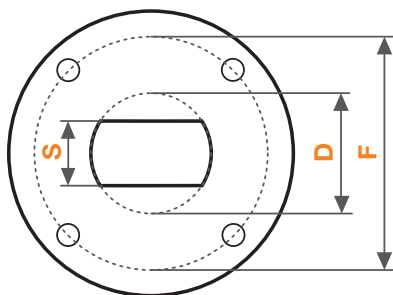
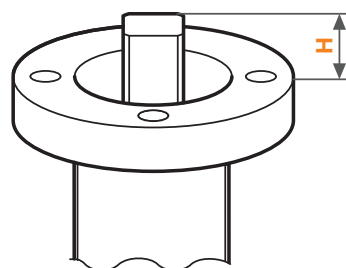

Flat head Selection table **page 10**

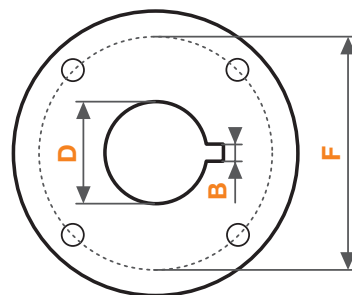

Wedge groove Selection table **page 10**

2

Selection table of actuator family and linkages – Square

Wrench size [mm]	Max. height [mm]	F Flange				
		F04 / F05	F05 / F07	F05	F07 / F10	F10
8	40				GR..-R ZGV-19 + ZGI-014	
	55	SR..-R ZSV-08	SR..P-R ZPV-08	SRF..-R ZSFV-08		
9	40				GR..-R ZGV-19 + ZGI-015	
	55	SR..-R ZSV-09	SR..P-R ZPV-09	SRF..-R ZSFV-09		
10	40				GR..-R ZGV-16 + ZGI-013	
	55	SR..-R ZSV-10	SR..P-R ZPV-10	SRF..-R ZSFV-10		
11	34					PR.. ZPR12 + ZGI-002
	40				GR..-R ZGV-16 + ZGI-004	
12	40				GR..-R ZGV-19 + ZGI-012	
	55	SR..-R ZSV-12	SR..P-R ZPV-12	SRF..-R ZSFV-12		
13	33				DR..-R ZDV-01	
	31					PR.. ZPR10
14	40				GR..-R ZGV-14	
	55	SR..-R ZSV-14	SR..P-R ZPV-14	SRF..-R ZSFV-14		
16	34					PR.. ZPR12
	40				GR..-R ZGV-16	
17	20				GR..-R ZGV-17	
	33				DR..-R ZDV-03	PR.. ZPR05
19	40				GR..-R ZGV-19	
22	40					SY4.. ZSY-011

Actuator family	Specific actuator must be determined in the table at step 3.
Linkage	Belimo type, can be ordered directly with this designation.

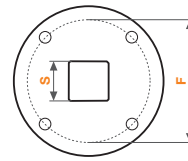

F Flange

2

Selection table of actuator family and linkages – Square 45° rotated

Wrench size [mm]	Max. height [mm]	F Flange						
		F04 / F05			F05 / F07	F05	F07	F10
8	40				GR..-R ZGV-19 + ZGI-014			
	55	SR..-R ZSV-08	SR..P-R ZPV-08	SRF..-R ZSFV-08				
9	40				GR..-R ZGV-19 + ZGI-015			
	55	SR..-R ZSV-09	SR..P-R ZPV-09	SRF..-R ZSFV-09				
10	40				GR..-R ZGV-16 + ZGI-013			
	55	SR..-R ZSV-10	SR..P-R ZPV-10	SRF..-R ZSFV-10				
11	29						PR.. ZPR15	PR.. ZPR15
	40				GR..-R ZGV-16 + ZGI-004			
	55	SR..-R ZSV-11	SR..P-R ZPV-11	SRF..-R ZSFV-11				
12	40				GR..-R ZGV-19 + ZGI-012			
	55	SR..-R ZSV-12	SR..P-R ZPV-12	SRF..-R ZSFV-12				
14	14					DR..-5 Direct mounting		
	24					PR.. ZPR03		
	31						PR.. ZPR06	PR.. ZPR06
	40				GR..-R ZGV-14			
	55	SR..-R ZSV-14	SR..P-R ZPV-14	SRF..-R ZSFV-14				
16	40				GR..-R ZGV-16			
	19					DR..-7 Direct mounting		
17	20				GR..-R ZGV-17			
	40					PR.. ZPR08		
	24					PR.. ZPR01		
18	31					PR.. ZPR11	PR.. ZPR11	
19	40				GR..-R ZGV-19			
22	40						SY4.. Direct mounting	
35	40						SY4.. Direct mounting	

Actuator family

Specific actuator must be determined in the table at step 3.

Linkage

Belimo type, can be ordered directly with this designation.

Direct mounting

Actuator can be mounted directly. No linkage necessary.

2

Selection table of actuator family and linkages – Flat head

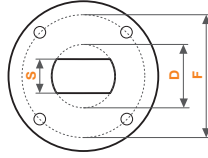

F Flange

Wrench size [mm] S	Max. height [mm] H	Diameter max. [mm] D	F04 / F05			F05 / F07		F05	F07 / F10
			SR..-R ZSF-08	SR..P-R ZPF-08	SRF..-R ZSFF-08	GR..-R ZGF-08		DR..-R ZDF-09	
8	36	11							
	55	17							
9	36	12							
	55	12							
10	55	17							
	30	27						PR.. ZPR13	
	55	14							
12.7	30	27						PR.. ZPR14	
13	33	19					DR..-R ZDV-01		
	31	28						PR.. ZPR10	
14	40	18					GR..-R ZGF-14		
	55	18							
16	34	31						PR.. ZPR12	
	33	31						PR.. ZPR05	
17	40	22					GR..-R ZGF-17	DR..-R ZDV-03	

Actuator family Specific actuator must be determined in the table at step 3.
Linkage Belimo type, can be ordered directly with this designation.

2

Selection table of actuator family and linkages – Wedge groove

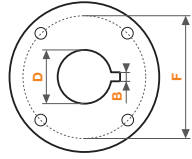

F Flange

Diameter [mm] D	Max. height [mm] H	Width [mm] B	F04 / F05		
			SR..-R ZSK-12	SR..P-R ZPK-12	SRF..-R ZSFK-12
12	55	4			
14	55	5			

Actuator family Specific actuator must be determined in the table at step 3.
Linkage Belimo type, can be ordered directly with this designation.

3

Actuator selection

Actuator family	Nominal torque	DN 25	DN 32	DN 40	DN 50	DN 65	DN 80	DN 100	DN 125	DN 150	DN 200	DN 250	DN 300
SR...-R	20 Nm	■	■	■	■	■	■						
SR...P-R		■	■	■	■	■	■						
SRF...-R		■	■	■	■	■	■						
GR...-R	40 Nm	■	■	■	■	■	■						
DR...-R								■	■	■			
DR...-5	90 Nm							■	■	■			
DR...-7								■	■	■			
PR..	160 Nm							■	■	■	■		
SY4..	400 Nm									■	■	■	■

■ Recommended ■ Recommended under certain circumstances





Actuator family	Actuator type	Nominal torque	Open/close	3-point	Modulating	Degree of protection	Fail-safe	Nominal voltage AC/DC 24 V AC 230 V	Running time motor 90°	Auxiliary switch SPDT
Standard actuators										
SR...-R	SR24A-R	20 Nm	■	■		IP54		24 V	90 s	
	SR230A-R		■	■			230 V			
GR...-R	GR24A-R	40 Nm	■			IP54		24 V	150 s	
	GR230A-R		■				230 V			
DR...-R	DR24A-R		■					24 V		
	DR230A-R		■				230 V			
DR...-5	DR24A-5	90 Nm	■			IP54		24 V	150 s	
	DR230A-5		■				230 V			
DR...-7	DR24A-7		■					24 V		
	DR230A-7		■				230 V			
RobustLine										
SR...P-R	SR24P-R	20 Nm	■	■		IP66 + IP67		24 V	90 s	
	SR230P-R		■	■			230 V			
Fast running actuators										
PR..	PRCA-S2-T	160 Nm	■	■		IP66 + IP67		AC 24...240 V DC 24...125 V	35 s ¹⁾	2
SY4..	SY4-24-3-T	400 Nm	■	■		IP67		24 V	16 s	2
	SY4-230-3-T		■	■			230 V	18 s	2	
Fail-safe actuators										
SRF...-R	SRFA-R	20 Nm	■		■	IP54		AC 24...240 V DC 24...125 V	75 s	2
	SRFA-S2-R		■		■					
PR..	PRKCA-BAC-S2-T	160 Nm	■	■	■ ²⁾	IP66 + IP67	■	AC 24...240 V DC 24...125 V	35 s ¹⁾	2
Modulating actuators										
PR..	PRCA-BAC-S2-T	160 Nm	■	■	■ ²⁾	IP66 + IP67		AC 24...240 V DC 24...125 V	35 s ¹⁾	2
SY4..	SY4-24-SR-T	400 Nm			■ ³⁾	IP67		24 V	16 s	2
	SY4-230-SR-T				■ ³⁾		230 V	18 s	2	
Communicative actuators										
SR...-R	SR24A-MP-R	20 Nm			■	IP54		24 V	90 s	
	SR24P-MP-R				■	IP66 + IP67				
GR...-R	GR24A-MP-R	40 Nm			■	IP54		24 V	90 s	
PR..	PRCA-BAC-S2-T	160 Nm	■	■	■ ²⁾	IP66 + IP67		AC 24...240 V DC 24...125 V	35 s ¹⁾	2
SY4..	SY4-24-MP-T	400 Nm			■ ³⁾	IP67		24 V	16 s	2
	SY4-230-MP-T				■ ³⁾		230 V	18 s	2	

¹⁾ 30...120 s variable

²⁾ 0...10 V, 2...10 V, 4...20 mA





³⁾ 0...10 V

Form fit adapter for valve stem, hexagonal

		Suitable for actuator				
		GR..	SR..	SR..P	SRF..	Type
	8x8x55 mm (LxWxH)				■	ZSFV-08
	9x9x55 mm (LxWxH)				■	ZSFV-09
	10x10x55 mm (LxWxH)				■	ZSFV-10
	11x11x55 mm (LxWxH)				■	ZSFV-11
	12x12x55 mm (LxWxH)				■	ZSFV-12
	14x14x55 mm (LxWxH)				■	ZSFV-14
	8x8x57 mm (LxWxH)		■			ZSV-08
	9x9x57 mm (LxWxH)		■			ZSV-09
	10x10x57 mm (LxWxH)		■			ZSV-10
	11x11x57 mm (LxWxH)		■			ZSV-11
	11x11x57 mm (LxBxH, inside square)		■			ZSV-11-4K
	12x12x57 mm (LxWxH)		■			ZSV-12
	14x14x57 mm (LxWxH)		■			ZSV-14
	14x14x40 mm (LxWxH)	■				ZGV-14
	16x16x40 mm (LxWxH)	■				ZGV-16
	17x17x20 mm (LxWxH)	■				ZGV-17
	19x19x40 mm (LxWxH)	■				ZGV-19
	8x8x57 mm (LxWxH)			■		ZPV-08
	9x9x57 mm (LxWxH)			■		ZPV-09
	10x10x57 mm (LxWxH)			■		ZPV-10
	11x11x57 mm (LxWxH)			■		ZPV-11
	12x12x57 mm (LxWxH)			■		ZPV-12
	14x14x57 mm (LxWxH)			■		ZPV-14



Form fit adapter for valve stem, two flats

Suitable for actuator

		GR..	SR..	SR..P	SRF..	Type
	8xØ17x55 mm (WxØxH)				■	ZSFF-08
	9xØ12x55 mm (WxØxH)				■	ZSFF-09
	10xØ17x55 mm (WxØxH)				■	ZSFF-10
	11xØ14x55 mm (WxØxH)				■	ZSFF-11
	14xØ18x55 mm (WxØxH)				■	ZSFF-14
	8xØ17x57 mm (WxØxH)		■			ZSF-08
	9xØ12x57 mm (WxØxH)		■			ZSF-09
	10xØ17x57 mm (WxØxH)		■			ZSF-10
	11xØ14x57 mm (WxØxH)		■			ZSF-11
	14xØ18x57 mm (WxØxH)		■			ZSF-14
	8xØ11x33 mm (WxØxH)	■				ZGF-08
	14xØ18x33 mm (WxØxH)	■				ZGF-14
	17xØ22x33 mm (WxØxH)	■				ZGF-17
	8xØ17x57 mm (WxØxH)			■		ZPF-08
	9xØ12x57 mm (WxØxH)			■		ZPF-09
	10xØ17x57 mm (WxØxH)			■		ZPF-10
	11xØ14x57 mm (WxØxH)			■		ZPF-11
	14xØ18x57 mm (WxØxH)			■		ZPF-14

Form fit adapter for valve stem, wedge groove

Suitable for actuator

		SR..	SR..P	SRF..	Type
	Ø12x4x55 mm (ØxWxH)			■	ZSFK-12
	Ø14x5x55 mm (ØxWxH)			■	ZSFK-14
	Ø12x4x57 mm (ØxWxH)	■			ZSK-12
	Ø14x5x57 mm (ØxWxH)	■			ZSK-14
	Ø12x4x57 mm (ØxWxH)		■		ZPK-12
	Ø14x5x57 mm (ØxWxH)		■		ZPK-14

Reducers / Form-fit adapters

	Suitable for actuator		Suitable for adapter		Type
	DR.-R		ZGY-16	ZGY-19	
	Reducer 14x14x20 mm (LxWxH)			■	ZGI-001
	Reducer 11x11x20 mm (LxWxH)		■		ZGI-002
	Reducer 14x14x35 mm (LxWxH)			■	ZGI-003
	Reducer 11x11x35 mm (LxWxH)		■		ZGI-004
	Reducer 11xØ17x15 mm (WxØxH)			■	ZGI-009
	Reducer 10xØ17x15 mm (WxØxH)			■	ZGI-010
	Reducer 12x12x35 mm (LxWxH)			■	ZGI-012
	Reducer 10x10x15 mm (LxWxH)		■		ZGI-013
	Reducer 8xØ17x15 mm (WxØxH)			■	ZGI-014
	Reducer 10x10x15 mm (LxWxH)			■	ZGI-015
	Form fit adapter, two flats 9xØ12x36 mm (WxØxH)	■			ZDF-09
	Form fit adapter, two flats 13xØ19x33 mm (WxØxH)	■			ZDV-01
	Form fit adapter, two flats 17x17x19 mm (LxWxH)	■			ZDV-02
Form fit adapter, two flats 13xØ19x33 mm (WxØxH)	■			ZDV-03	

Adapter kit for SY..

	Type
 Mounting/adapter kit for SY4/5/6 Square 35x35 mm to flat head SW22	ZSY-011

Adapter kits for PR.. / PRK..

	Square				Flat head					Type	
	SW14	SW16	SW17	SW18	SW11	SW12.7	SW14	SW16	SW17		SW18
	F05	■					■				ZPR10
	F07, square 45° turned			■							ZPR08
				■					■		ZPR05
		■					■				ZPR09
	F07/F10		■					■			ZPR12
					■						ZPR13
						■					ZPR14
		■					■				ZPR06
	F07/F10, square 45° turned			■						■	ZPR11

Auxiliary switches

		Auxiliary switch SPDT	Suitable for actuator			Type
			DR..-R	GR..-R	SR..-R	
	Add-on auxiliary switch 1 mA...3 (0.5) A, AC 250 V Adjustable switching point 0...100%	1	■	■	■	S1A
		2	■	■	■	S2A

Feedback potentiometer

		Resistance	Suitable for actuator			Type
			DR..-R	GR..-R	SR..-R	
	Add-on feedback potentiometer	140 Ω	■	■	■	P140A
		200 Ω	■	■	■	P200A
		500 Ω	■	■	■	P500A
		1 kΩ	■	■	■	P1000A
		2.8 kΩ	■	■	■	P2800A
		5 kΩ	■	■	■	P5000A
		10 kΩ	■	■	■	P10000A

All inclusive.

Belimo as a global market leader develops innovative solutions for the controlling of heating, ventilation and air-conditioning systems. Actuators, valves and sensors represent our core business.

Always focusing on customer added value, we deliver more than only products. We offer you the complete product range for the regulation and control of HVAC systems from a single source. At the same time, we rely on tested Swiss quality with a five-year warranty. Our worldwide representatives in over 80 countries guarantee short delivery times and comprehensive support through the entire product life. Belimo does indeed include everything.

The "small" Belimo devices have a big impact on comfort, energy efficiency, safety, installation and maintenance. In short: Small devices, big impact.



5-year warranty



On site around the globe



Complete product range



Tested quality



Short delivery times



Comprehensive support



BELIMO Automation AG

Brunnenbachstrasse 1, 8340 Hinwil, Switzerland
+41 43 843 61 11, info@belimo.ch, www.belimo.eu

