

- Torque motor 20 Nm
- Nominal voltage AC/DC 24 V
- Control communicative
- Communication via BACnet MS/TP or Modbus RTU

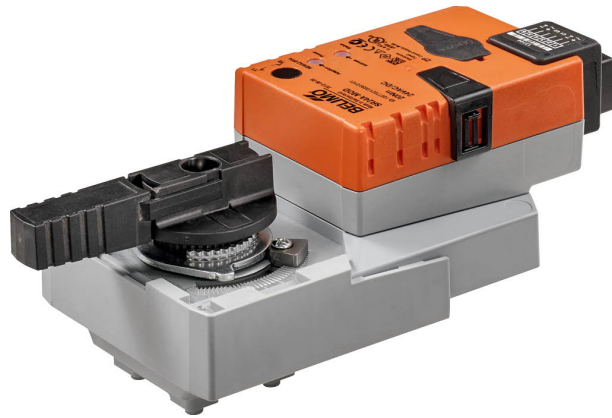

Technical data

Electrical data	Nominal voltage	AC/DC 24 V
	Nominal voltage frequency	50/60 Hz
	Nominal voltage range	AC 19.2...28.8 V / DC 21.6...28.8 V
	Power consumption in operation	3.5 W
	Power consumption in rest position	1.25 W
	Power consumption for wire sizing	6 VA
	Connection supply / control	Connector socket RJ12
Data bus communication	Communicative control	BACnet MS/TP Modbus RTU (default setting)
	Number of nodes	BACnet / Modbus see interface description
Functional data	Torque motor	20 Nm
	Manual override	with push-button, can be locked
	Running time motor	90 s / 90°
	Running time motor variable	90...350 s
	Adaptation setting range	manual (automatic on first power-up)
	Adaptation setting range variable	No action Adaptation when switched on Adaptation after pushing the manual override button
	Override control, controllable via bus communication	MAX (maximum position) = 100% MIN (minimum position) = 0% ZS (intermediate position) = 50%
	Override control variable	MAX = (MIN + 33%)...100% MIN = 0%...(MAX - 33%) ZS = MIN...MAX
	Sound power level, motor	45 dB(A)
	Position indication	Mechanical, pluggable
Safety data	Protection class IEC/EN	III, Safety Extra-Low Voltage (SELV)
	Power source UL	Class 2 Supply
	Degree of protection IEC/EN	IP40 IP54 when using protective cap or protective grommet for RJ12 socket
	Degree of protection NEMA/UL	NEMA 1
	Enclosure	UL Enclosure Type 1
	EMC	CE according to 2014/30/EU
	Certification IEC/EN	IEC/EN 60730-1 and IEC/EN 60730-2-14
	UL Approval	cULus according to UL60730-1A, UL60730-2-14 and CAN/CSA E60730-1 The UL marking on the actuator depends on the production site, the device is UL-compliant in any case

Safety data	Type of action	Type 1
	Rated impulse voltage supply / control	0.8 kV
	Pollution degree	3
	Ambient humidity	Max. 95% RH, non-condensing
	Ambient temperature	-30...50°C [-22...122°F]
	Storage temperature	-40...80°C [-40...176°F]
	Servicing	maintenance-free
Weight	Weight	1.0 kg

Safety notes

- This device has been designed for use in stationary heating, ventilation and air-conditioning systems and must not be used outside the specified field of application, especially in aircraft or in any other airborne means of transport.
- Outdoor application: only possible in case that no (sea) water, snow, ice, insulation or aggressive gases interfere directly with the device and that it is ensured that the ambient conditions remain within the thresholds according to the data sheet at any time.
- Only authorised specialists may carry out installation. All applicable legal or institutional installation regulations must be complied during installation.
- The switch for changing the direction of rotation may only be operated by authorised specialists. The direction of rotation must not in particular be reversed in a frost protection circuit.
- The device may only be opened at the manufacturer's site. It does not contain any parts that can be replaced or repaired by the user.
- The device contains electrical and electronic components and must not be disposed of as household refuse. All locally valid regulations and requirements must be observed.

Product features

Mode of operation	The actuator is fitted with an integrated interface for BACnet MS/TP and Modbus RTU, it receives the digital control signal from the control system and returns the current status.
Parametrisable actuators	<p>The factory settings cover the most common applications. Single parameters can be modified with the Belimo Service Tools MFT-P or ZTH EU.</p> <p>The communication parameters of the bus systems (address, baud rate etc.) are set with the ZTH EU. Pressing the "Address" button on the actuator while connecting the supply voltage, resets the communication parameters to the factory setting.</p> <p>Quick addressing: The BACnet and Modbus address can alternatively be set using the buttons on the actuator and selecting 1...16. The value selected is added to the «Basic address» parameter and results in the effective BACnet and Modbus address.</p>
Simple direct mounting	Straightforward direct mounting on the ball valve with only one central screw. The assembly tool is integrated in the plug-in position indication. The mounting orientation in relation to the ball valve can be selected in 90° steps.
Manual override	Manual override with push-button possible (the gear train is disengaged for as long as the button is pressed or remains locked).
Adjustable angle of rotation	Adjustable angle of rotation with mechanical end stops.
High functional reliability	The actuator is overload protected, requires no limit switches and automatically stops when the end stop is reached.
Home position	<p>The first time the supply voltage is switched on, i.e. at the time of commissioning, the actuator carries out an adaptation, which is when the operating range and position feedback adjust themselves to the mechanical setting range.</p> <p>The actuator then moves into the position defined by the control signal.</p> <p>Factory setting: Y2 (counter-clockwise rotation).</p>

Adaptation and synchronisation

An adaptation can be triggered manually by pressing the "Adaptation" button or with the PC-Tool. Both mechanical end stops are detected during the adaptation (entire setting range). Automatic synchronisation after pressing the manual override button is configured. The synchronisation is in the home position (0%). The actuator then moves into the position defined by the control signal. A range of settings can be adapted using the PC-Tool (see MFT-P documentation)

Accessories

Mechanical accessories	Description	Type
	Grommet for RJ connection module, Multipack 50 pcs.	Z-STRJ.1
Tools	Description	Type
	Service Tool, with ZIP-USB function, for parametrisable and communicative Belimo actuators, VAV controller and HVAC performance devices	ZTH EU
	Belimo PC-Tool, Software for adjustments and diagnostics	MFT-P
	Connecting cable 5 m, A: RJ11 6/4 ZTH EU, B: 6-pin for connection to service socket	ZK1-GEN

Electrical installation



Always fit feed pins in pairs!

Only attach and remove connecting cable when de-energised!

The wiring of the line for BACnet MS/TP / Modbus RTU is to be carried out in accordance with applicable RS-485 regulations.

Modbus / BACnet: Supply and communication are not galvanically isolated. Connect earth signal of the devices with one another.

Maximum cable length for star wiring <5 m.

Maximum baud rate for star wiring 38'400 Bd.

Functions:

C1 = D- = A

C2 = D+ = B

Wiring diagrams

RJ12 socket

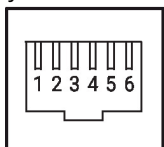

- 1 AC/DC 24 V
- 2 Com
- 3 D - (A)
- 4 D + (B)
- 5 AC/DC 24 V
- 6 Com

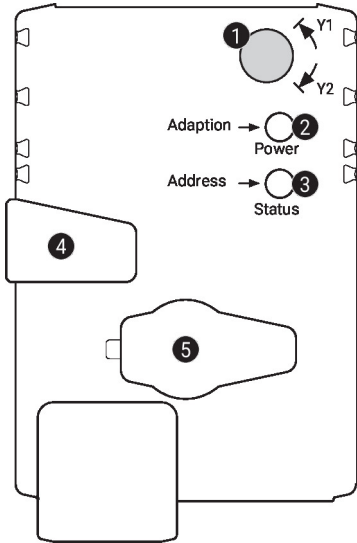
Operating controls and indicators

1 Direction of rotation switch

Switch over: Direction of rotation changes

2 Push-button and LED display green

Off: No power supply or malfunction
 On: In operation
 Flashing: In address mode: Pulses according to set address (1...16)
 When starting: Reset to factory setting (Communication)
 Press button: In standard mode: Triggers angle of rotation adaptation
 In address mode: Confirmation of set address (1...16)

3 Push-button and LED display yellow

Off: Standard mode
 On: Adaptation or synchronisation process active
 or actuator in address mode (LED display green flashing)
 Flickering: BACnet / Modbus communication active
 Press button: In operation (>3 s): Switch address mode on and off
 In address mode: Address setting by pressing several times
 When starting (>5 s): Reset to factory setting (Communication)

4 Manual override button

Press button: Gear train disengages, motor stops, manual override possible
 Release button: Gear train engages, standard mode

5 Service plug

For connecting parametrisation and service tools

Check power supply connection

2 Off and **3** On Possible wiring error in power supply

Service
Quick addressing

1. Press the "Address" button until the green "Power" LED is no longer illuminated. LED flashes in accordance with the previously set address.
 2. Set the address by pressing the "Address" button the corresponding number of times (1...16).
 3. The green LED flashes in accordance with the address that has been entered (...16). If the address is not correct, then this can be reset in accordance with Step 2.
 4. Confirm the address setting by pressing the green "Adaptation" button.
- If no confirmation occurs for 60 seconds, then the address procedure is ended. Any address change that has already been started will be discarded.
- The resulting BACnet MS/TP and Modbus RTU address is made up of the set basic address plus the short address (e.g. 100+7=107).

Tools connection The actuator can be parametrised by ZTH EU via the service socket.
For an extended parametrisation the PC tool can be connected.

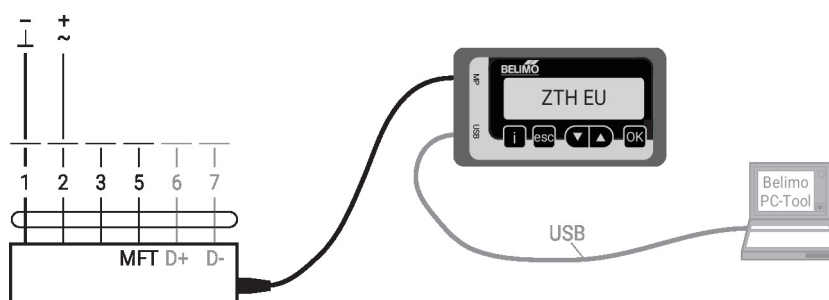
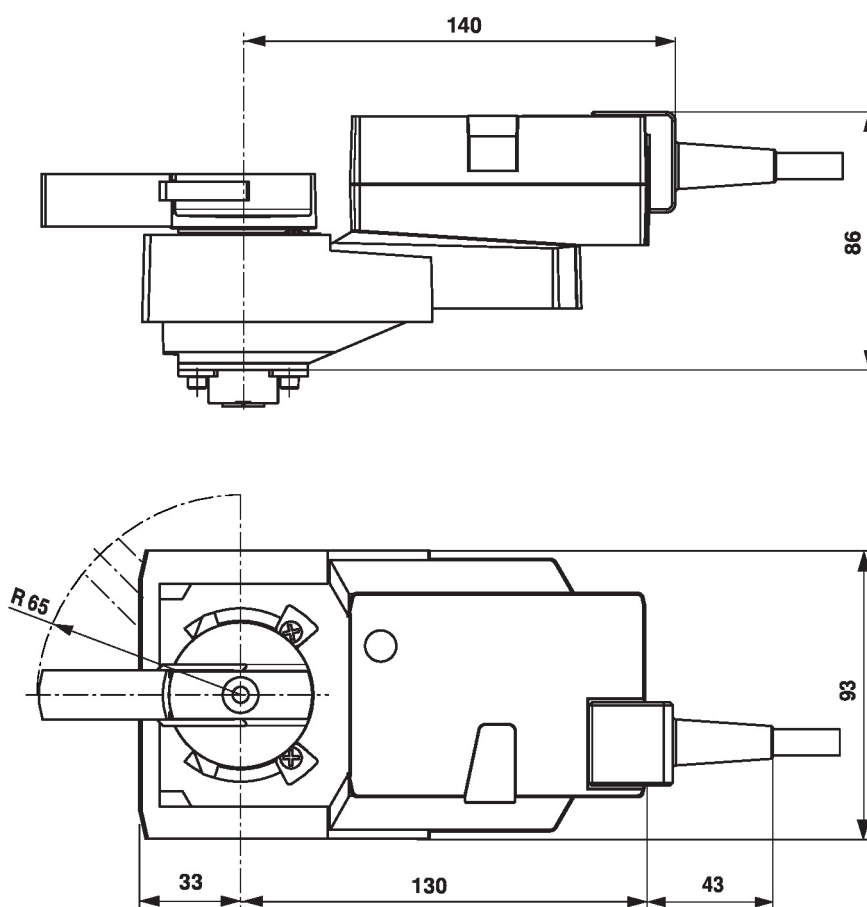
Dimensions

Further documentation

- Tool connections
- BACnet Interface description
- Modbus Interface description
- The complete product range for water applications
- Data sheets for ball valves
- Installation instructions for actuators and/or ball valves
- General notes for project planning