

Rotary actuator fail-safe for butterfly valves

- Torque motor Max. 90 Nm
- Nominal voltage AC/DC 24 V
- Control Open/close

Technical data

Electrical data	Nominal voltage	AC/DC 24 V	
	Nominal voltage frequency	50/60 Hz	
	Nominal voltage range	AC 19.2...28.8 V / DC 21.6...28.8 V	
	Power consumption in operation	11 W	
	Power consumption in rest position	2 W	
	Power consumption for wire sizing	20 VA	
	Power consumption for wire sizing note	Imax 20 A @ 5 ms	
	Connection supply / control	Cable 1 m, 2 x 0.75 mm ²	
	Parallel operation	Yes (note the performance data)	
Functional data	Torque motor	Max. 90 Nm (not constant)	
	Setting fail-safe position	NC/NO, adjustable (POP rotary knob)	
	Bridging time (PF)	2 s	
	Manual override	with push-button	
	Running time motor	150 s / 90°	
	Running time fail-safe	35 s / 90°	
	Sound power level, motor	52 dB(A)	
	Sound power level, fail-safe	61 dB(A)	
	Position indication	Mechanical, integrated	
Safety data	Protection class IEC/EN	III, Safety Extra-Low Voltage (SELV)	
	Power source UL	Class 2 Supply	
	Degree of protection IEC/EN	IP54	
	Degree of protection NEMA/UL	NEMA 2	
	Enclosure	UL Enclosure Type 2	
	EMC	CE according to 2014/30/EU	
	Certification IEC/EN	IEC/EN 60730-1 and IEC/EN 60730-2-14	
	UL Approval	cULus according to UL60730-1A, UL60730-2-14 and CAN/CSA E60730-1 The UL marking on the actuator depends on the production site, the device is UL-compliant in any case	
	Type of action	Type 1.AA	
	Rated impulse voltage supply / control	0.8 kV	
	Pollution degree	3	
	Ambient humidity	Max. 95% RH, non-condensing	
	Ambient temperature	-30...50°C [-22...122°F]	
	Storage temperature	-40...80°C [-40...176°F]	
	Servicing	maintenance-free	
	Mechanical data	Connection flange	F07
		Weight	Weight
		3.9 kg	

Terms Abbreviations

POP = Power off position / fail-safe position
 CPO = Controlled power off / controlled fail-safe
 PF = Power fail delay time / bridging time

Safety notes



- This device has been designed for use in stationary heating, ventilation and air-conditioning systems and must not be used outside the specified field of application, especially in aircraft or in any other airborne means of transport.
- Outdoor application: only possible in case that no (sea) water, snow, ice, insolation or aggressive gases interfere directly with the device and that it is ensured that the ambient conditions remain within the thresholds according to the data sheet at any time.
- Only authorised specialists may carry out installation. All applicable legal or institutional installation regulations must be complied during installation.
- The device may only be opened at the manufacturer's site. It does not contain any parts that can be replaced or repaired by the user.
- Cables must not be removed from the device.
- The device contains electrical and electronic components and must not be disposed of as household refuse. All locally valid regulations and requirements must be observed.

Product features

Mode of operation The actuator moves the valve to the desired operating position at the same time as the integrated capacitors are loaded. Interrupting the supply voltage causes the valve to be moved to the selected fail-safe position by means of stored electrical energy.

Pre-charging time (start up) The capacitor actuators require a pre-charging time. This time is used for charging the capacitors up to a usable voltage level. This ensures that, in the event of a power failure, the actuator can move at any time from its current position into the preset fail-safe position. The duration of the pre-charging time depends mainly on how long the power was interrupted.

Typical pre-charging time

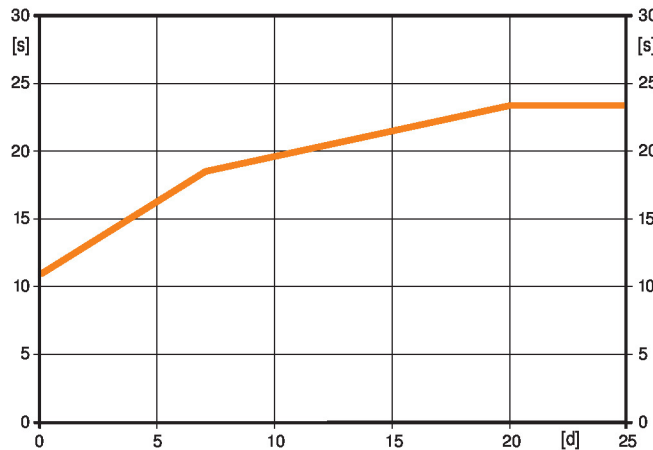

[d] = Electricity interruption in days
 [s] = Pre-charging time in seconds

	[d]		
	0	7	≥20
[s]	11	18	23

Delivery condition (capacitors) The actuator is completely discharged after delivery from the factory, which is why the actuator requires approximately 20 s pre-charging time before initial commissioning in order to bring the capacitors up to the required voltage level.

Setting fail-safe position (POP) The rotary knob fail-safe position can be used to adjust the desired fail-safe position. In the event of a power failure, the actuator drives to the selected fail-safe position, taking into account the bridging time (PF) of 2 s set at the factory.

- Simple direct mounting** Simple direct mounting on the butterfly valve. The mounting orientation in relation to the butterfly valve can be selected in 90° (angle) increments.
- Manual override** Manual control with push-button possible - temporary. The gear train is disengaged and the actuator decoupled for as long as the button is pressed.
- High functional reliability** The actuator is overload protected, requires no limit switches and automatically stops when the end stop is reached.
- Torque not constant** Due to the non-linear torque characteristic the actuator can only be used for butterfly valves and not for other armatures.

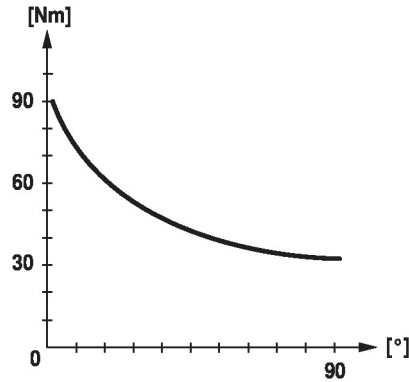
Accessories

Electrical accessories	Description	Type
	Auxiliary switch 1 x SPDT add-on	S1A
	Auxiliary switch 2 x SPDT add-on	S2A
	Feedback potentiometer 140 Ω add-on	P140A
	Feedback potentiometer 200 Ω add-on	P200A
	Feedback potentiometer 500 Ω add-on	P500A
	Feedback potentiometer 1 kΩ add-on	P1000A
	Feedback potentiometer 2.8 kΩ add-on	P2800A
	Feedback potentiometer 5 kΩ add-on	P5000A
	Feedback potentiometer 10 kΩ add-on	P10000A

Electrical installation

Supply from isolating transformer.
Wire colours:

- 1 = black
- 2 = red

Wiring diagrams

AC/DC 24 V, open/close

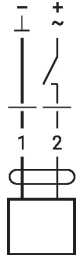

1	2	
		A - AB = 0%
		A - AB = 100%

Operating controls and indicators

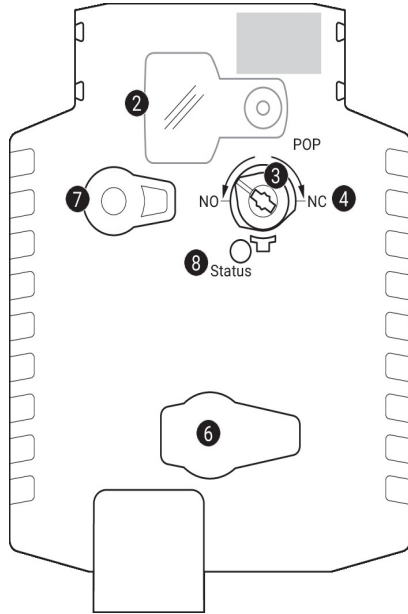

- 2 Cover, POP button
- 3 POP button
- 4 Scale for manual adjustment
- 6 (no function)
- 7 Manual override button

Press button: Gear train disengages, motor stops, manual override possible
 Release button: Gear train engages, standard mode

LED displays

green 8	Meaning / function
On	Operation OK
Flashing	POP function active
Off	- Not in operation - Pre-charging time SuperCap - Fault SuperCap

Setting emergency setting position (POP)

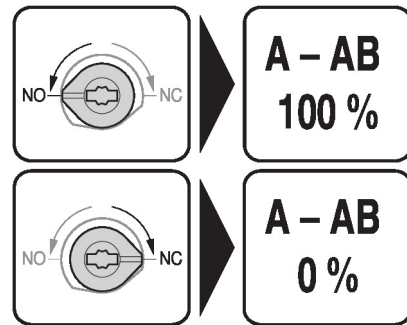
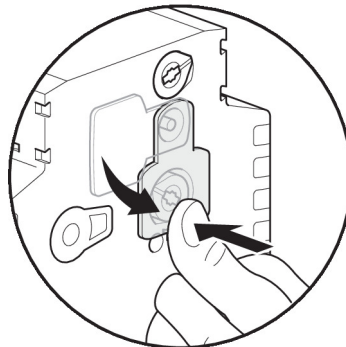
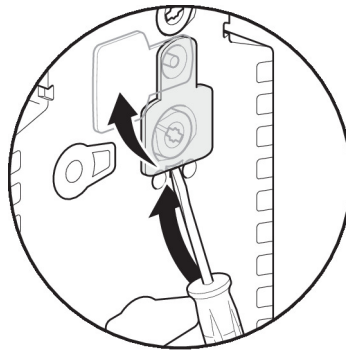

Dimensions

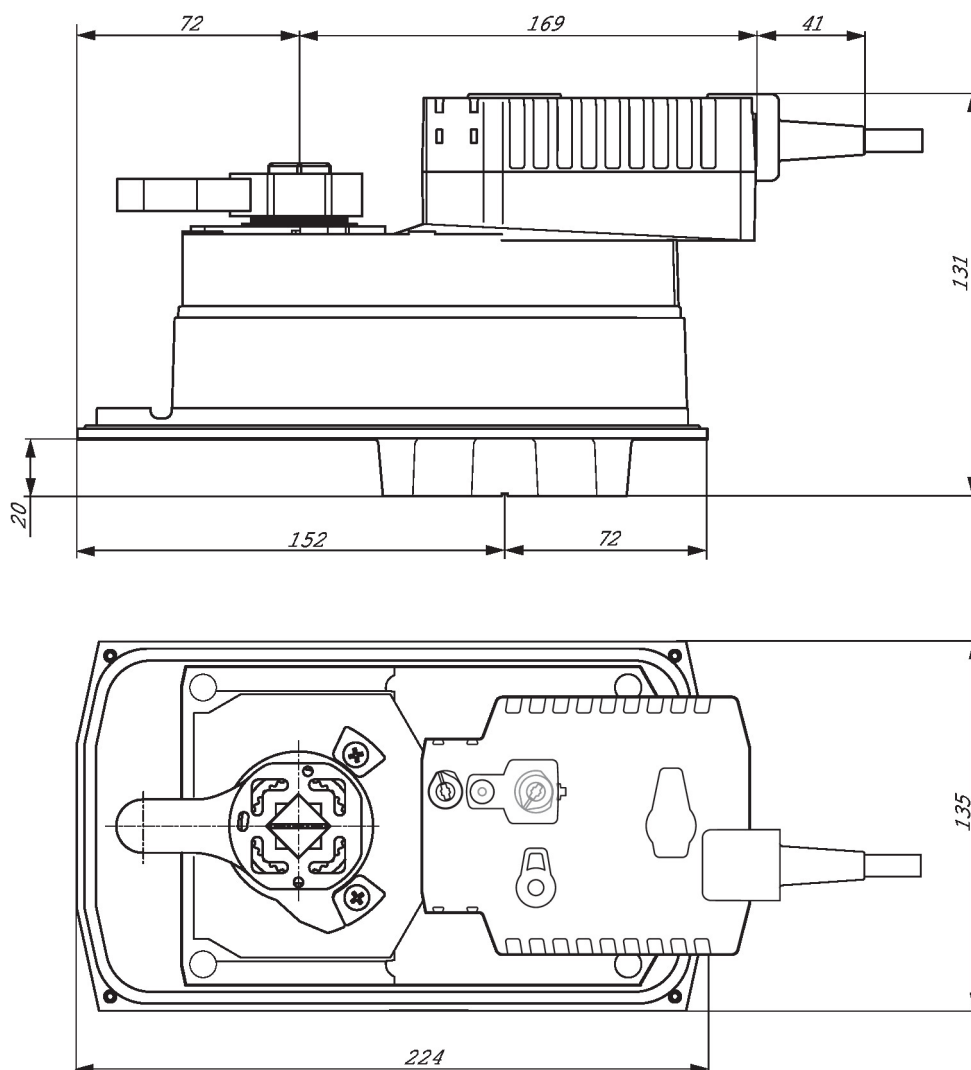

Further documentation

- The complete product range for water applications
- Data sheets for butterfly valves
- Installation instructions for actuators and/or butterfly valves
- General notes for project planning