



Belimo Energy Valve™

Application Guide



Visit us at:
belimo.com/energy-valve

BELIMO[®]

General Information

This is the Belimo Energy Valve™ application guide, a central source of information for the planning, selection, and application of the Belimo Energy Valve™. It is intended to provide educational and practical support on this flagship Belimo product to consulting engineers, system integrators, HVAC contractors, commissioning engineers, facility managers and building owners worldwide. Belimo Energy Valve™ is a registered trademark of Belimo. For easier reading, it is also referred to as Energy Valve or EV throughout this guide.

In this guide, you will find information on the following topics:

- Development of valve technology
- The difference between pressure-dependent and pressure-independent technology
- Mechanical versus electronic pressure-independent technology
- An overview of the Energy Valve and its features
- Common applications
- Best practices, including installation and commissioning tips
- Supporting tools, resources and FAQs

TABLE OF CONTENTS

PART A	Introduction to the Belimo Energy Valve™	4
PART B	Belimo Energy Valve™ HVAC Applications	60
PART C	Installation and Configuration	114

This guide can be printed or downloaded as required. It serves as a resource for standard questions and solutions, and to increase your knowledge of the Belimo Energy Valve™ and its most common applications. However, it does not replace professional engineering work. If questions that are more complex arise, please consult your local Belimo contact person or use the Belimo support hotline ([see www.belimo.com](http://www.belimo.com)).

PART A

Introduction to the Belimo Energy Valve™

OVERVIEW OF KEY FUNCTIONS AND FEATURES

1 Evolution of Control Valves	6
2 Pressure-independent valve technology	10
3 What is a Belimo Energy Valve™?	20
4 Control Modes of the Belimo Energy Valve™	30
5 Feature overview of the new Belimo Energy Valve™	48

1

Evolution of Control Valves

Control valve technology has evolved significantly over the last two decades – from the simple actuation on a valve to truly smart valves. Smart valves can actuate to more than just different opening positions. They have various flow and/or temperature sensors installed within the valve body, and/or in the water stream.

The combination of valve, actuator, and sensors allows the smart valve to automate many processes that would otherwise be difficult or too time-consuming to implement.

1.1 CCV (Characterized Control Valve)

Globe valves dominated the HVAC control valve market for decades, but, in 1999, Belimo released its **Characterised Control Valve (CCV)**. Thanks to the innovative characterised disc, which achieves an equal-percentage characteristic curve, this product perfectly combines the air-bubble-tight shut-off of a ball valve with the optimum controllability of a heat exchanger. The CCV is also air-bubble tight, i.e. it does not allow water to flow through the closed valve.



Abb. 1: CCV

1.2 Pressure-Independent Characterised Control Valve (PICCV)

In 2003, the first **pressure-independent characterised control valve (PICCV)** from Belimo came onto the market. Using the same valve technology found in the CCV, a robust mechanical pressure regulator was integrated to compensate for pressure changes in the system. This allowed the desired flow rate to remain constant, despite differential pressure fluctuations.



Abb. 2: PICCV

1.3 Electronic pressure-independent characterised control valve (EPIV)

In 2010, after four years of development, Belimo launched the **electronic pressure-independent characterised control valve (EPIV)**. The EPIV enables real-time flow measurement directly integrated in the valve unit. The EPIV combines an accurate, wet-calibrated ultrasonic flow sensor with a characterised control valve in one device. This combination allows for precise control of the flow rate with the capability of reading the actual flow rate at all times.



Abb. 3: EPIV

1.4 Belimo Energy Valve™

In 2012, the first version of the **Belimo Energy Valve™** was introduced. The Energy Valve is an enhancement of the EPIV, with temperature sensors in the supply and return for measuring the **differential temperature** (known as delta T) across the heat exchanger. This, along with the built-in software, allows the valve to continually monitor and enhance the efficiency of the heat exchange.

The Belimo Energy Valve™ marks a new chapter with advanced connectivity. In addition to the analogue and bus interfaces (Modbus, BACnet and MP-Bus), the Energy Valve has an integrated web server. This simplifies commissioning and supports the operator during operation. In addition, the Energy Valve can be connected to the Internet, making it the first IoT (**Internet of Things**) control valve for HVAC applications.

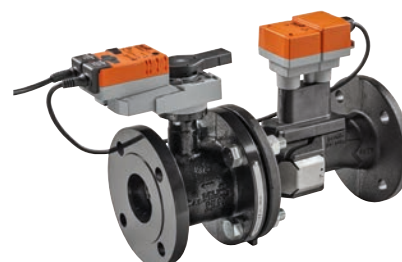

Abb. 4: Energy Valve



1.5 Quick Compact Valve (QCV)

In 2013, the ZoneTight™ **QCV** was introduced for zone applications, allowing more accurate control of small water volumes. It combines the air-bubble tight ball valve design from Belimo with an extremely power-saving actuator and fast, tool-free actuator mounting.

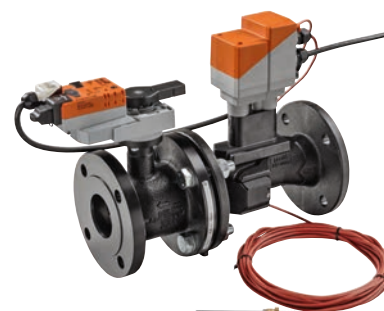

Abb. 5: QCV

1.6 Pressure-Independent Quick Compact Valve (PIQCV)

In 2016, the ZoneTight™ product family became **pressure-independent**. The **PIQCV** combines mechanical pressure independence and ZoneTight™ technology for zone applications.



Abb. 6: PIQCV

1.7 Belimo Energy Valve™ – bringing together what belongs together

In 2021, a new product range of certified thermal energy meters and the Belimo Energy Valve™ 4 were launched. It offers seamless and direct integration in building management systems (BMS) and in third-party IoT platforms, and provides valuable data on current operation modes, temperatures, flows or energy consumption, which can then be used directly for energy billing.

All these Belimo innovations have helped solve severe problems and inefficiencies in the hydronic control of HVAC systems, including leaking valves, discomfort from pressure fluctuations, and of course reduced efficiency from the producer due to low delta T syndrome.



Abb. 7: Belimo Energy Valve™ 4

→ Pro Tip

Retrofit of obsolete valve and actuator technology is the first step to energy efficiency. Combining the latest air-bubble tight, pressure-independent valve with modern, efficient variable-speed pumps, significantly reduces current consumption while simultaneously increasing occupant comfort. Consult your local Belimo representative for assistance.

1.8 Belimo set the new industry standard twice, for innovative valve and actuator technology

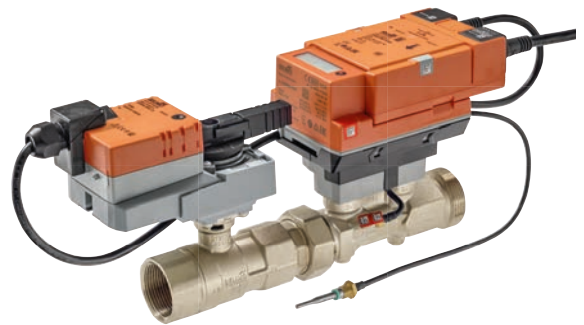
CCV and Zone Valves: In the space of just ten years, Belimo had clearly established the new industry standard for control valves with the Characterised Control Valve (CCV). Beginning in 2013, ZoneTight™ QCV also experienced an exponential growth spurt with high volumes for zone applications. It is foreseeable that in the coming decade, a large number of outdated short-stroke zone valves will be replaced by energy-efficient and 'air bubble tight' Belimo QCV zone valves.

PI-Valves: Pressure-independent valves have experienced strong growth over the last five years. This is driven by compact, mechanically pressure-independent PIQCV zone valves, which are replacing the pressure-dependent short-stroke globe valves that are outdated in many applications. Nonetheless, the fast market penetration of electronic pressure-independent valves, such as the EPIV and Belimo Energy Valve™, continues.

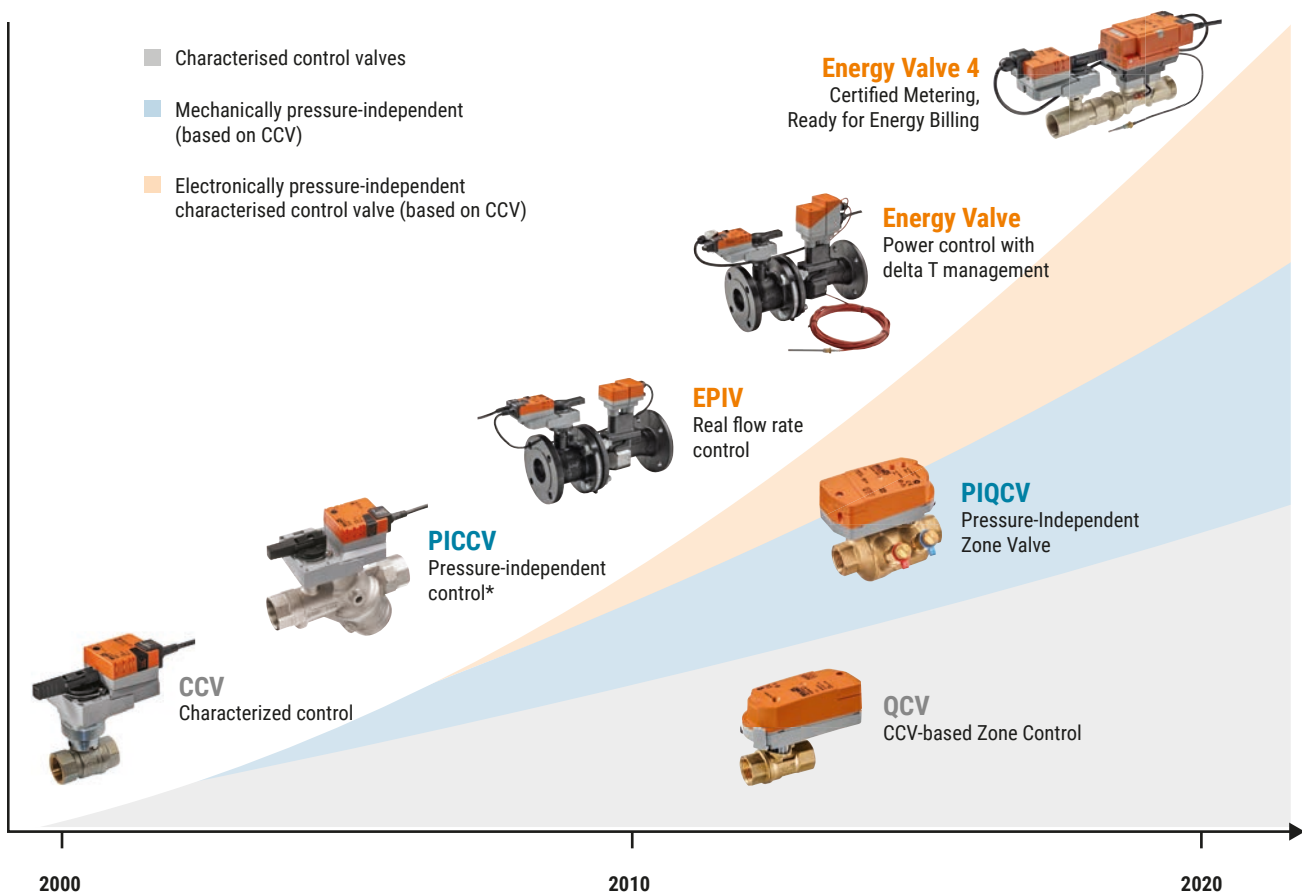

*PICCV has since been replaced by PIQCV and EPIV.

2

Pressure-independent valve technology

The drive towards greater HVAC efficiency led to variable flow systems and 2-way control valves, thus requiring control valves to operate under dynamic conditions. However, conventional control valves continue to be sized to static design conditions, making valve selection, balancing, and control problematic. To address this, Belimo released the first pressure-independent valve designed for the HVAC industry.

2.1 The traditional approach

Pressure-dependent valves

In pressure-dependent systems, the typical arrangement consists of a manual balancing valve in series with a pressure-dependent control valve. Typically, the balancing valves have a machined orifice, which allows the technician to measure differential pressure (known as delta P) to obtain the flow value. The flow is determined either by calculation from measured differential pressure and flow coefficients (Cv/Kv) or with the aid of flow/delta P tables.

Although variable flow systems save building operators substantial pump energy cost every year, complex flow issues caused by pressure fluctuations can arise, resulting in system instabilities. Even the best-designed systems still make it challenging to optimise operations, especially during partial load operation.

Pressure-dependent valves can suffer from differential pressure fluctuations due to differential pressure changes in the system. These flow fluctuations thereby result in excessively high or excessively low power output at the heat exchanger.

2.2 Pressure-independent valves

Maintain the flow, independent of pressure fluctuations

Since 2003, when Belimo was one of the first manufacturers to produce a pressure-independent control valve, these valves – often referred to as PI valves, PIV or PICV – have significantly changed the way HVAC systems are designed, installed, and commissioned in buildings. They offer savings at virtually every stage of a building's life cycle.

For nearly two decades, pressure-independent valves have demonstrated the ability to mitigate costly problems associated with systems with pressure-dependent valves. This has provided huge improvements in flow consistency irrespective of system pressure fluctuations. PI valves maintain the flow rate through each coil/heat exchanger, permitting flow changes only when commanded to do so by the control signal. The result: No fluctuations in heating or cooling output due caused by differential pressure variations.



Abb. 8: PICCV, the first Belimo pressure-independent valve.

2.3 Mechanical PI valves

The key components

A mechanical PI valve, sometimes also referred to as a dual valve, combines a control valve with a differential pressure regulator. The pressure regulator maintains a constant pressure across the control element, which results in a defined flow at a specific position. Furthermore, the differential pressure across the entire valve can be measured by means of P/T connections (optional). This enables optimisation of the pump setting when at full load.

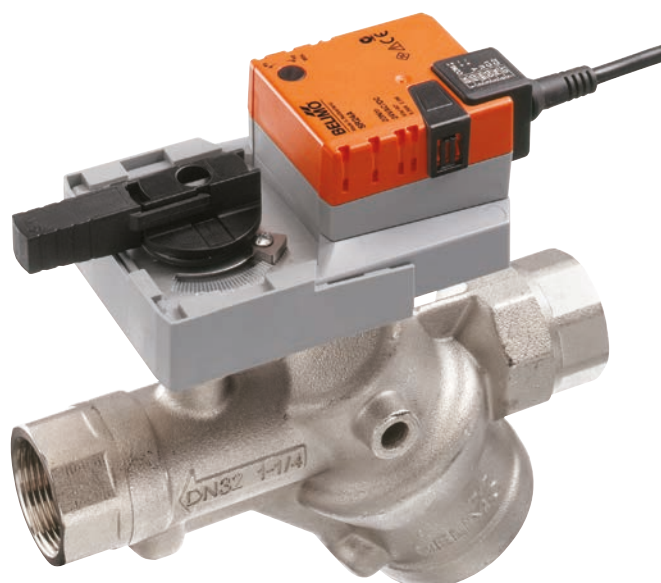

Abb. 9: Components of a mechanical PI valve, e.g. a PIQCV.

How mechanical PI valves work

PI valves require a minimum differential pressure to operate. This differential pressure is required to load the spring, which positions the diaphragm. If a hydronic system provides a differential pressure below this minimum, the pressure regulator mechanism is unable to respond to pressure changes effectively, making the valve pressure-dependent and making it behave like one of that type. If the maximum differential pressure of the valve is exceeded, the diaphragm will experience additional stress, which can damage the pressure regulator if left for extended periods. Usually, hydronic systems are designed such that they deliver the differential pressure within the required range, with little or no additional equipment or design overhead.

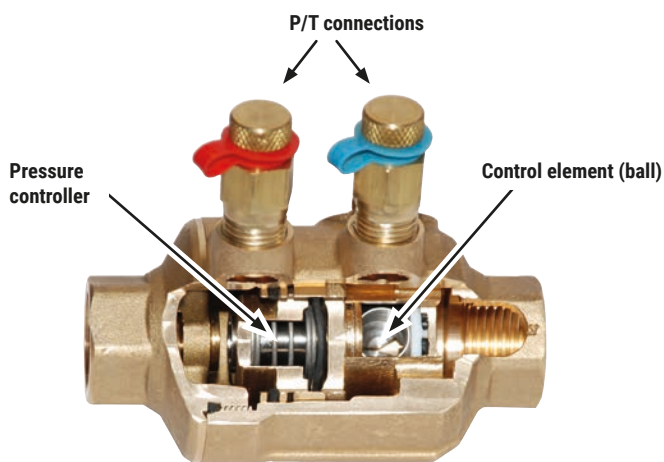

Abb. 10: Stabilising pressure and flow changes with a mechanical PI valve, e.g. a PIQCV.

Advantages of mechanical PI valves over pressure-dependent valves

By controlling flow and eliminating the effects of pressure fluctuations, pressure-independent valves eliminate the need for extra balancing valves. This not only minimises the installation costs, but also significantly reduces the costs for commissioning, as labour-intensive hydronic balancing is no longer required. PI valves can be preset to the calculated maximum flow value on site. They can also be set to full flow to allow higher flow rates during system flushing before being set to the design flow.

The key to the success of the mechanical PI valve is simplicity during planning, installation, and commissioning, increased room comfort thanks to correct flow rates, and flexibility for future conversions. PI valves are selected on flow, and do not require flow coefficient (kvs value) or valve authority calculations. Future changes to the building's existing hydronic system will not affect PI valves that have already been installed, preventing costly rebalancing or comfort problems.

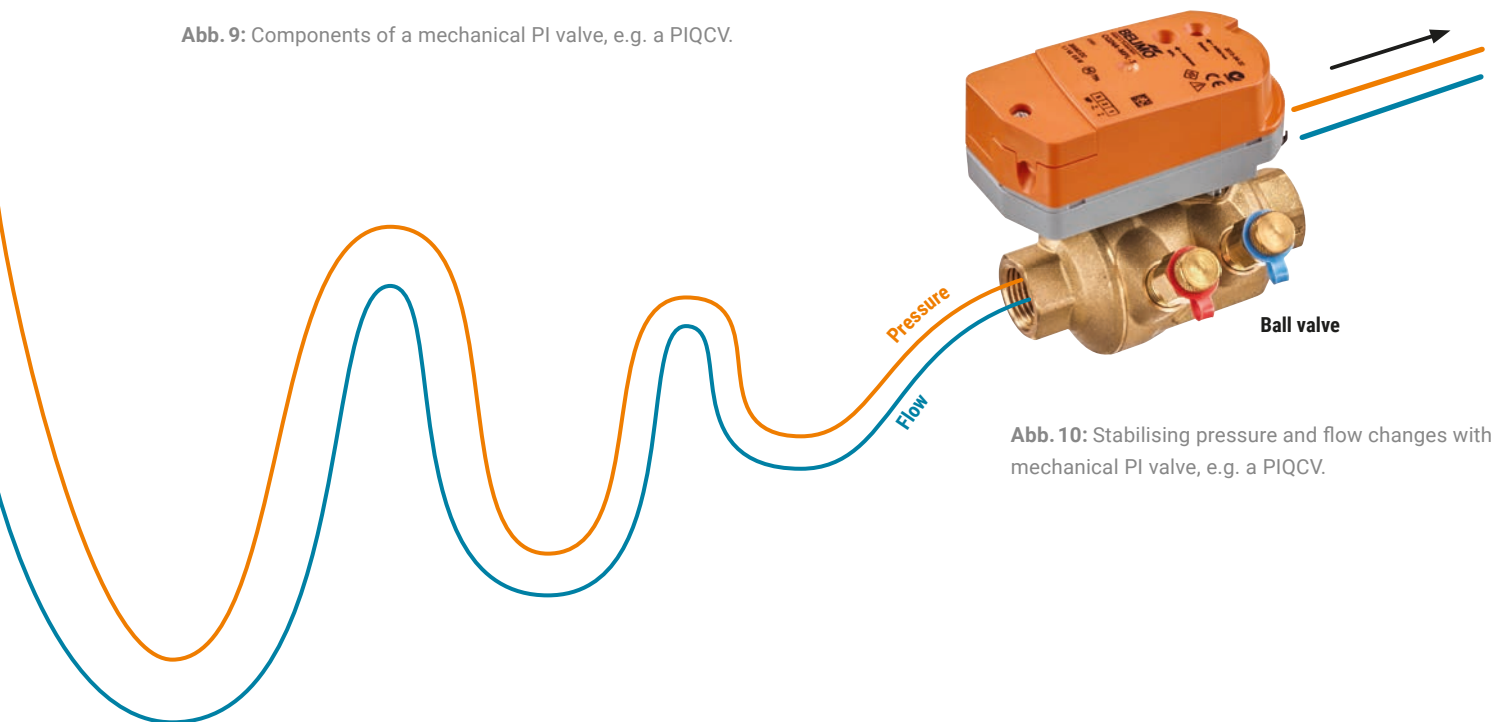
Value added to the system with PI valves

Building owners realise the benefits of PI valves with energy savings and increased occupant comfort. Installers save considerable amounts of work by not having to install balancing valves and by the reduced commissioning effort.

In summary, pressure-independent valves stabilise the control of variable flow systems, offering greater efficiency and worry-free, dynamic balancing, thus making installation and commissioning significantly easier tasks.

Challenges with mechanical PI valves

If you wish to measure the flow through the valve, you need an additional device such as a machined disc. Although many PI valves are equipped with P/T connections, they should be used only to measure differential pressure. The pressure drop across the PI valve body is not suitable for

flow calculations as its geometry moves with the controller as a result of pressure changes. If you intend to verify flow with an external device, careful attention should be paid to the combined tolerance of both the valve and the measuring station. For example, if both devices have a stated tolerance of +/- 10%, a measured value of anywhere between 80% and 120% of design should be considered acceptable.

There are several PI valves on the market that attempt to display a theoretical or calculated flow based on the valve position. This is often based on the assumption that the delta P over the valve is within the required range, and that sufficient flow is available. Unfortunately, mechanical PI valves do not report delta P or the diaphragm position.



Abb. 11: Improved sturdiness with mechanical PI valves.

2.4 Electronic PI valves

For almost a decade, Belimo electronic PI valves have registered fast growth as more and more customers enjoy the peace of mind and comfort they have with this innovative product.

What are the components of an ePIV?

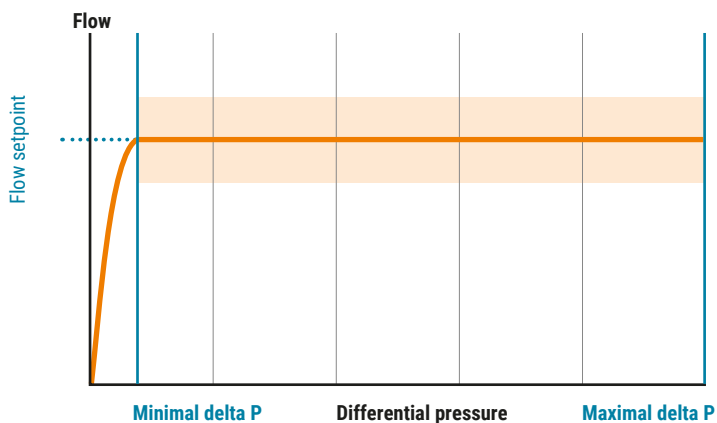
An electronic PI valve combines a flow sensor with patented glycol concentration measurement, a high-resolution actuator and a flow control logic unit in a single device. Flow measurement data from the meter can be recorded via analogue interfaces or digital communication via Belimo MP-Bus and BACnet or Modbus. This provides valuable data for your building management system and gives insight into your hydronic system.



Abb. 12: Belimo electronic PI valve, e.g. an EPIV.

How does the EPIV work?

The electronic pressure-independent valve (EPIV) uses technology very similar to the pressure-independent VAV unit used in air-side applications. By using algorithms, the control signal is interpreted into a flow requirement that positions the valve to provide the correct flow rate at all times. This is even the case with differential pressure fluctuations and at partial load.

Thanks to the innovative control logic in the electronic valve, very high control accuracy is achieved.

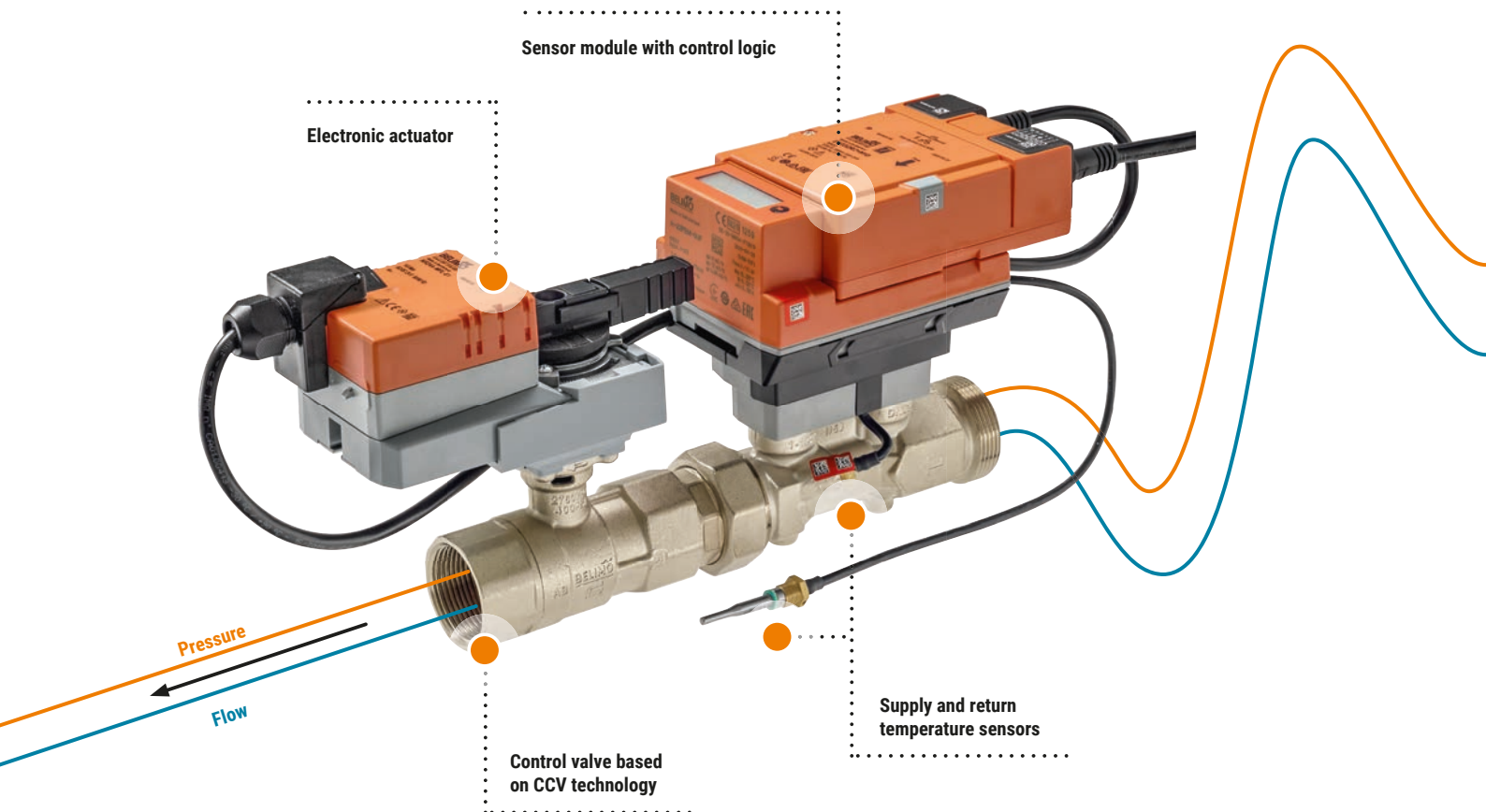
Like mechanical PI valves, electronic PI valves also require a minimum differential pressure to overcome the resistance of the fully opened valve unit. However, since no internal differential pressure controller needs to be activated, the minimum required differential pressure is typically lower with an electronic solution. This enables further savings in pump operation.



Abb. 13: Electronic PI valves can typically maintain the flow rate at lower delta P than can mechanical PI valves.

2.5 What advantages do electronic PI valves offer over mechanical PI valves?

Commissioning

Continuous true flow measurement has removed all the flow verification frustrations associated with mechanical PI valves, either from an assumed flow using valve position or trying to read flow from an external device. By reporting the actual flow rates to the building management system, there is no need for hydronic balancing and therefore no long and costly commissioning.

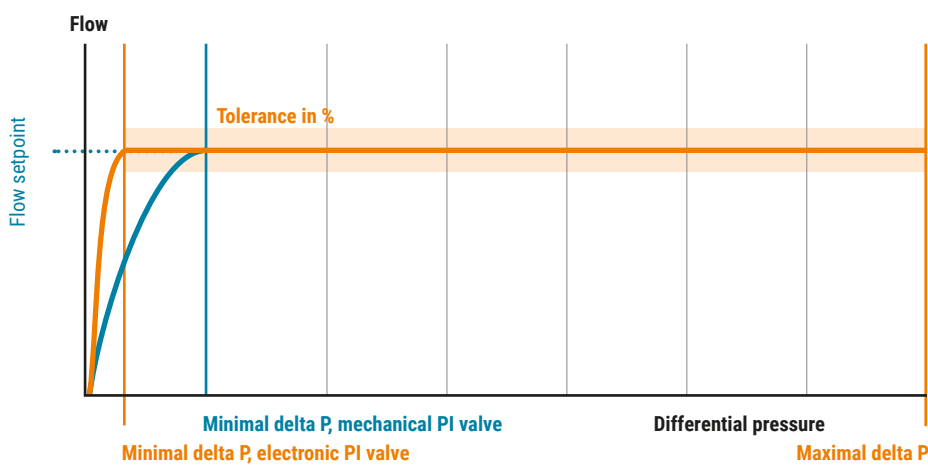
Operation transparency

Product longevity and reliability should go hand in hand. Control valves, once commissioned, are rarely checked again during a building's lifetime. Both pressure dependent and mechanical PI valves can, and often will deviate from design. This can be either due to the difficulty in adjusting the flow during commissioning, or due to not knowing whether the regulator is working correctly in the case of mechanical PI valves. An electronic valve will always report its flow, ensuring your piece of mind over the lifetime of the device. A failed valve will become obvious to an operator and can be alarmed on the **BMS**, or become an alert on your analytics software.

Improved dirt performance

By eliminating the mechanical differential pressure regulator, the risk of blockage due to contamination is also considerably reduced. For example, even with the smallest nominal diameter of the EPIV, particles with diameters of up to 6 mm can still pass through the open valve unit.



Abb. 14: Electronic PI valves have a simple flow path, which enables changes in the direction of flow to be dispensed with while at the same time significantly improving dirt tolerance.

2.6 Optimised pump operation based on the position of the electronic PI valves

An electronic pressure-independent control valve automatically adjusts the valve opening to ensure the flow required by the building automation system (BMS).

- Increasing differential pressure across the valve is compensated by reducing the valve opening.
- Decreasing differential pressure across the valve is compensated by increasing the valve opening.



Abb. 15: Compensation of pressure fluctuations by changing the valve opening.

→ Pro Tip

Using the data provided from Energy Valves, you can optimise this process. Section 5.7 of this guide explains more.

The valve opening as a function of the setpoint and the differential pressure across the Energy Valve can be read out via the BMS. The bad point in the system can be determined by recording the feedback signals of all of the Energy Valves. The pump head can be controlled, based on the valve that is widest open in the current operating state.

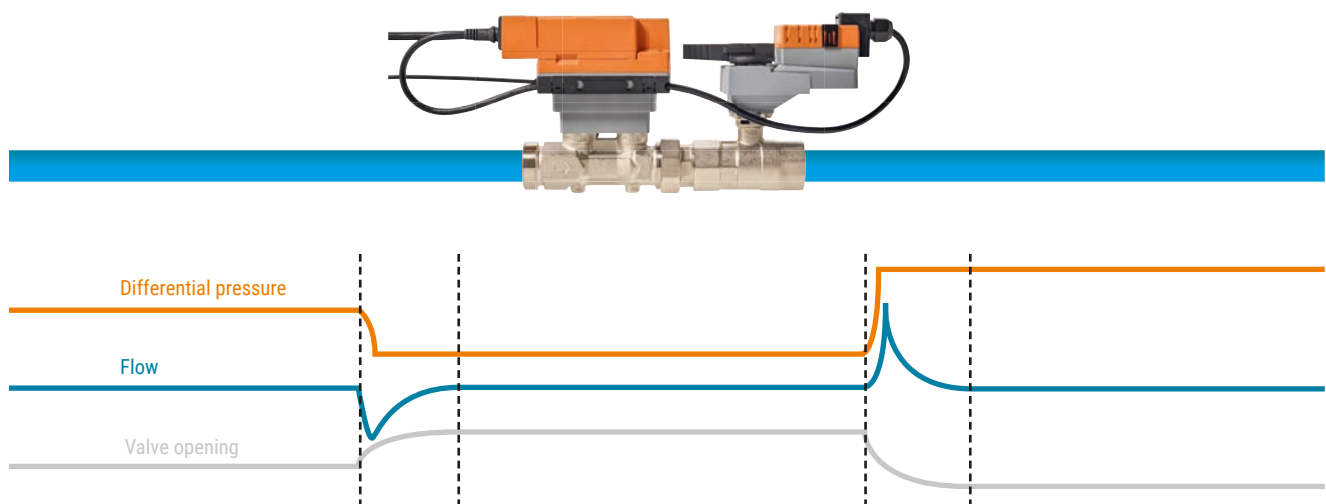

Abb. 16: Compensation of pressure fluctuations by changing the valve opening.

Unlike the use of a differential pressure sensor at the bad point for pump control, shifting of the bad point in the system is therefore not a problem, as it can be easily detected.

Pump control can be carried out, based on the largest valve opening.

- If none of the Energy Valves are almost completely open, then the pump head is currently too high. The pump speed can be reduced.
- If one or more Energy Valves are completely open, then the pump head is currently too low. The pump speed must be increased.

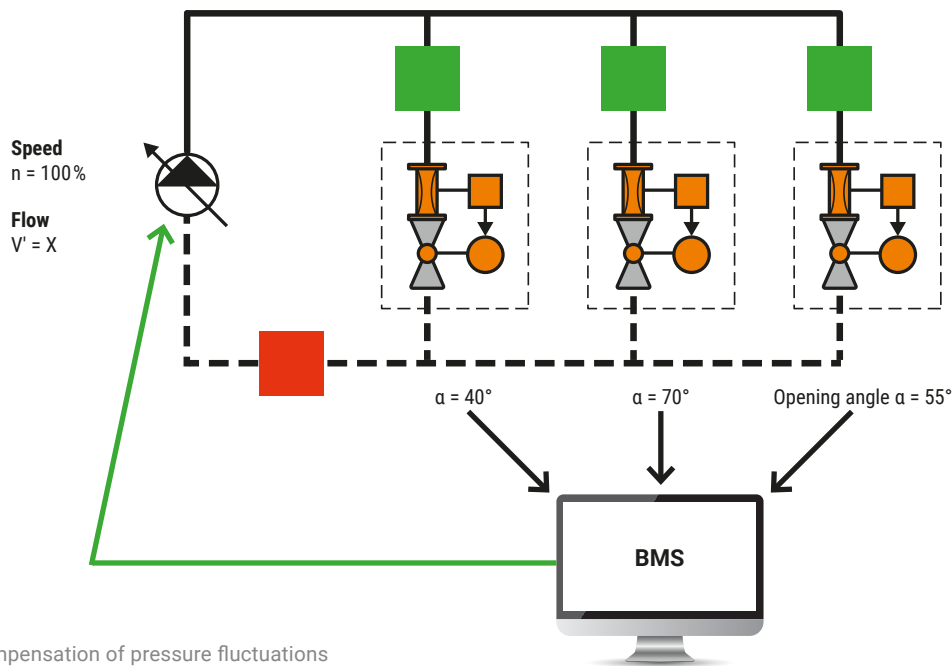

Abb. 17: An example of pump control using the Energy Valve at the bad point.

This innovative control of the pump head enables extremely energy-efficient operation for every load case.

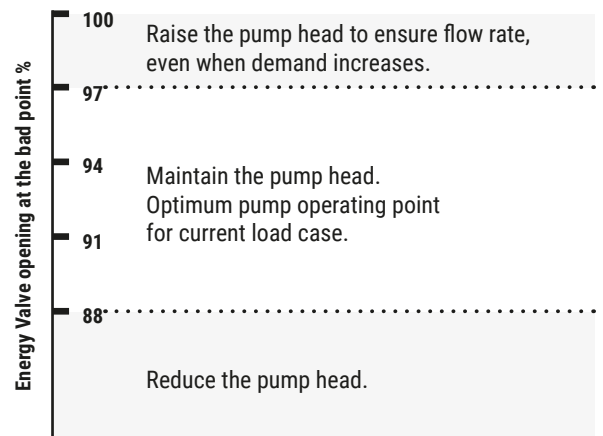

Abb. 18: Optimised operation

Mechanical vs. electronic PI valve – effects on pump head

In order to ensure a constant flow rate, the differential pressure across the regulating device of a mechanically pressure-independent valve is maintained by a pressure-reducing valve integrated in the same valve body. Activation of the integrated differential pressure controller always requires the same minimum differential pressure. Accordingly, no pump control can be implemented that is based on the feedback of the valve position of a mechanical pressure-independent control valve.

→ Pro Tip

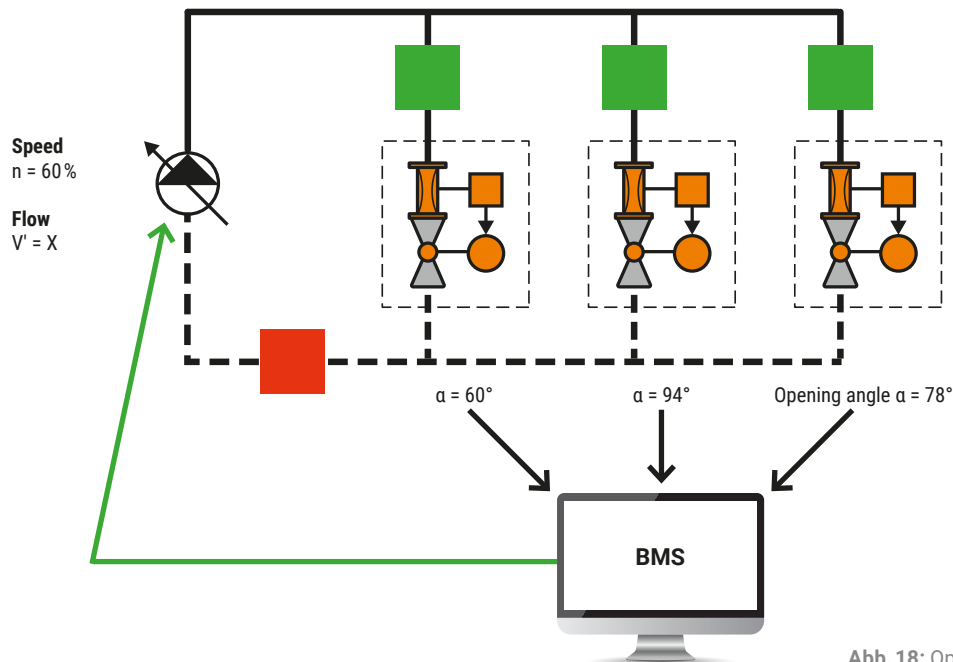
If you are planning pump control based on the opening of the Energy Valves, you will need a BMS that is able to communicate quickly with the installed valves, analyse data, and make control decisions.

3

**What is a Belimo
Energy Valve™ ?**

3.1 Main features

The **Belimo Energy Valve™** is a smart, pressure-independent control valve for HVAC applications. It is based on **Belimo characterised control valve technology (CCV)**, which ensures air-bubble tight shut-off and thus reliably prevents activation losses. The flow through the valve is permanently measured with an ultrasonic flow sensor. The sensor measures accurately and incorporates a patented method to detect and compensate for glycol. The accurate flow information is used to electronically **compensate for any pressure fluctuation** in the system. In combination with the temperature sensors in the flow and return, it is also used to **measure the energy** delivered that is given off via a consumer.

The Energy Valve has integrated power control and Belimo **delta T manager** logic for monitoring power and optimising heat exchange by maintaining a minimum, freely adjustable differential temperature. In addition to the standard analogue signal and feedback wiring, the Energy

Valve communicates its data to the building management system (BMS) via Belimo MP-Bus, BACnet or Modbus communication. The built-in web server makes the Energy Valve easy to parametrise and enables clear visualisation of the valves' operation in real time. Performance data is stored for 13 months on the actuator. The Belimo Cloud provides the option of lifetime data.

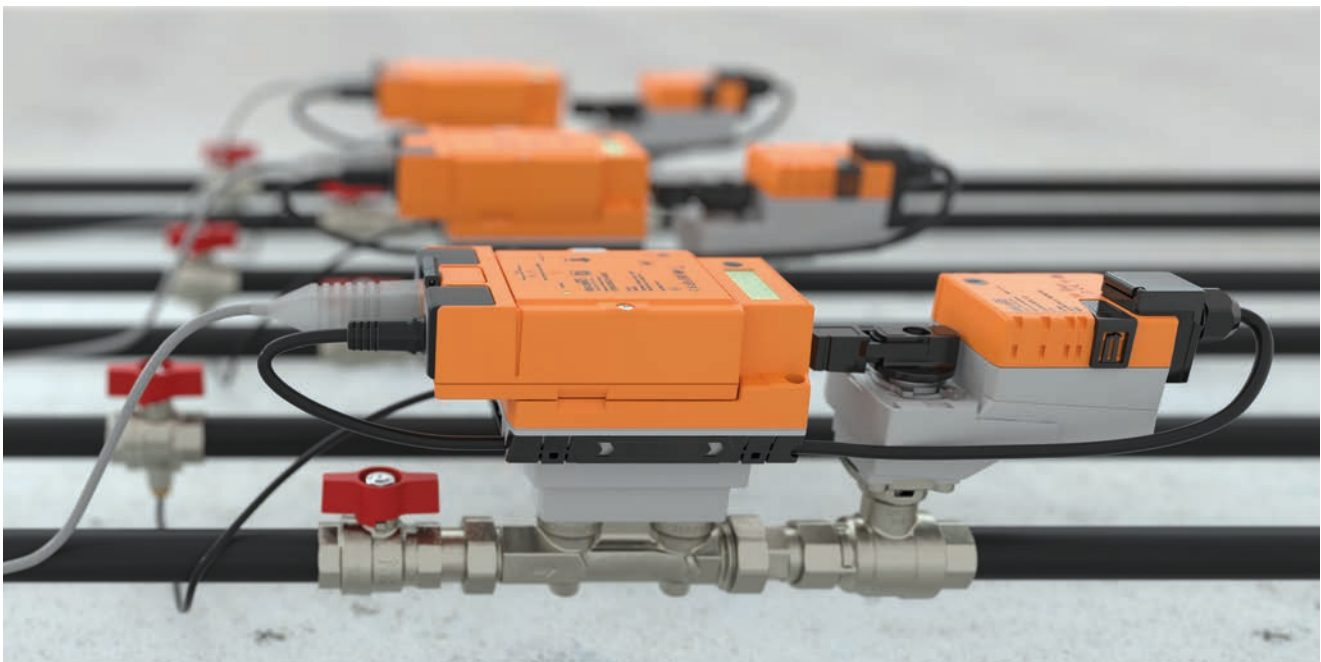

Overview of the most important features of the Belimo Energy Valve™



Abb. 19: Key features of the Energy Valve solution.

3.2 Energy valve strengths

CCV strengths

Thanks to its design, the characterised control valve (CCV) has an equal-percentage characteristic curve. This ensures stable control even in the low flow range. The CCV is also 'air bubble tight', meaning it does not permit any water to pass through the valve when closed.

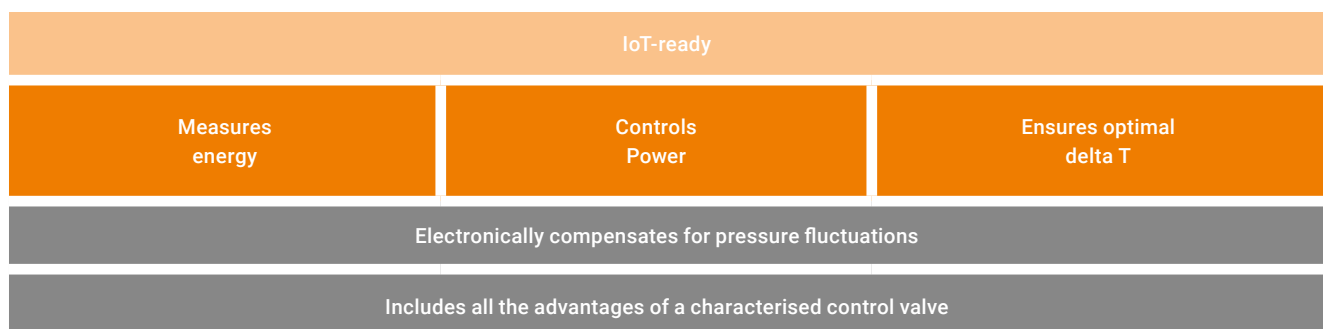
Compensates pressure electronically

Using a flow sensor and a modern high-resolution actuator, the Energy Valve regulates itself to provide the required flow rate. Energy Valves sense pressure changes as changes in flow. They react to pressure changes by moving the actuator until the correct flow is achieved, remaining there until either another pressure change is experienced, or the required flow is changed.

Measure energy

Flow through the valve is measured continuously using a wet-calibrated, ultrasonic flow sensor. In conjunction with two temperature sensors (flow and return), the valve measures the energy delivered to the heat exchanger.

Power control

Not only can the valve measure energy, it can also control it. The control signal is converted into a power demand (heating or cooling capacity), which makes the valve control independent of all other system parameters (e.g. differential pressure, water temperatures, air-side conditions, etc.).

Manage delta T

Delta T is an excellent indicator of the efficiency of the heat exchange. The Energy Valve offers two options for ensuring Delta T: One for fixed supply temperatures and the other for systems with fluctuating supply temperatures.

Digital-ready

In addition to the standard analogue signal and feedback wiring, the Belimo Energy Valve™ can transmit its data to the building management system (BMS) via Belimo MP-Bus, BACnet or Modbus communication. The integrated web server facilitates parametrisation of the Energy Valve and enables a clear visualisation of the operation of the valves in real time. Performance data is stored for 13 months on the actuator. The Belimo Cloud provides the option of lifetime data.

3.3 Delta T, and why it's important

Efficiency gains and pump savings

While the formula for heat exchange is exact, the reality of the buildings' operation is far from exact. Our quest for comfort has made modulating control valves and variable air volumes a reality. However, this turns optimum heat exchange into a moving target, as ideal air volume and water flow rates are interdependent and non-linear.

The temperature spread between the water entering and leaving a heat exchanger is commonly referred to as delta T. This is a measure of how much energy the water has given up as it passed through the heat exchanger. If this is lower than expected, less energy is being given up. This is inefficient because a considerable amount of energy is put into the water and a further amount of energy is expended moving the water around the building.

A low delta T also means that too much water is flowing through the heat exchanger. The Energy Valve prevents these large amounts of water by throttling the water flow until the heat exchanger delivers the desired amount of energy. This is a crucial feature of the Energy Valve.

Reducing the flow rates to optimise the heat exchange has significant impacts on the pumps and the system. For this reason, many district heating providers charge users who supply too high a return temperature due to the delta T being too small.

Figure 20 shows the pump affinity law, which shows us that the relationship between pump power consumption and flow is cubed. A 30% reduction in flow corresponds to a reduction in energy consumption of around 65%.

A low delta T is not just about pump power savings either. A delta T that is too low also has a negative impact on the generation of cooling or heating energy. A return temperature that deviates from the ideal state, resulting from the low delta T syndrome, reduces the efficiency of energy generation in many cases (e.g. cooling units or condensing boilers).

$$\frac{P2}{P1} = \left(\frac{V2}{V1} \right)^3$$

Abb. 20: Pump affinity law

3.4 Components of the Belimo Energy Valve™

The electronic actuator positions the valve precisely according to the flow requirement.

2-way characterised control valve with air-bubble tight shut-off and 0% leakage.

Ultrasonic flow sensor with temperature and glycol compensation.

Supply and return temperature sensors for recording the differential temperature (delta T).



Abb. 21: The components of the Belimo Energy Valve™.

3.5 Product range and key specifications

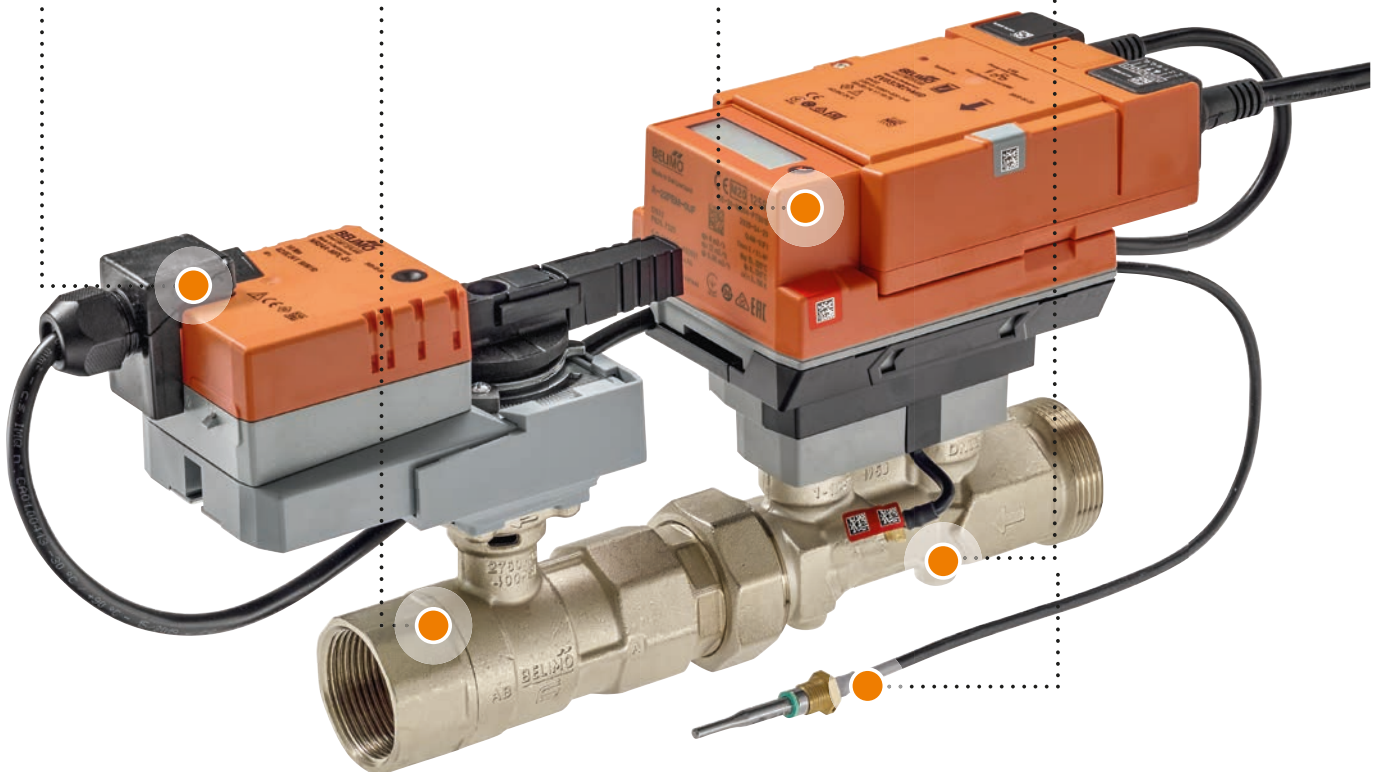

Belimo Energy Valve™

Nominal diameter [mm]	15	20	25	32	40	50	65	80	100	125	150
Nominal diameter [in]	1/2	3/4	1	1 1/4	1 1/2	2	2 1/2	3	4	5	6
V'nom [l/min]	25	41.7	58.3	100	166.7	250	480	660	1200	1860	2700
V'nom [GPM]	6.6	11	18.2	28.5	44	100	127	180	317	495	713
Adjustable maximum water volume at 100% demand (V'max) in % of V'nom	DN 15...50 / DN 25...100						DN 30...100				

3.6 Belimo Energy Valve™ features

Energy Monitoring

Permanently measures and logs the energy consumption of the application, the flow rate and the differential temperature across the coil. This provides full system transparency.

Glycol Monitoring

An advanced, patented algorithm determines the percentage glycol content in the fluid. This enables continuous monitoring during system operation. In addition, energy measurement always takes place with the correct flow values. Available only for non-MID certified products.

Power control

The power control redefines the control possibilities of a control valve. This dynamic mode provides the only truly linear relationship between control signal and power output. This control mode makes the Energy Valve independent of both the differential pressure and the supply temperature, thereby providing more comfort and minimising control oscillations while at the same time increasing system efficiency.

Low Minimum Pressure Drop

Electronic PI valves typically have a much lower pressure drop than mechanical PI valves, and therefore require significantly lower differential pressures to achieve the designed flow. This allows the use of smaller pump types and energy savings.

Characterised control valve technology

Improves controllability at partial load, prevents contamination thanks to self-cleaning ball technology and prevents leakage thanks to air bubble tightness.

7-year warranty

If the Energy Valve is permanently connected to the cloud, the warranty period is automatically extended by an additional two years, for a total of seven years.

Delta T manager

This function continuously monitors the coil delta T and compares it to the desired delta T setpoint. If the actual delta T falls below the setpoint for a pre-determined period, the mode is activated and adjusts the flow until the delta T is at or above the set minimum.

Bus communication / NFC

NFC and bus communication enable the reading of current values and the writing of settings or parametrisation via handheld tools, BACnet IP / MS/TP, Modbus RTU / TCP/IP, Belimo MP-Bus networks and via an integrated web server.

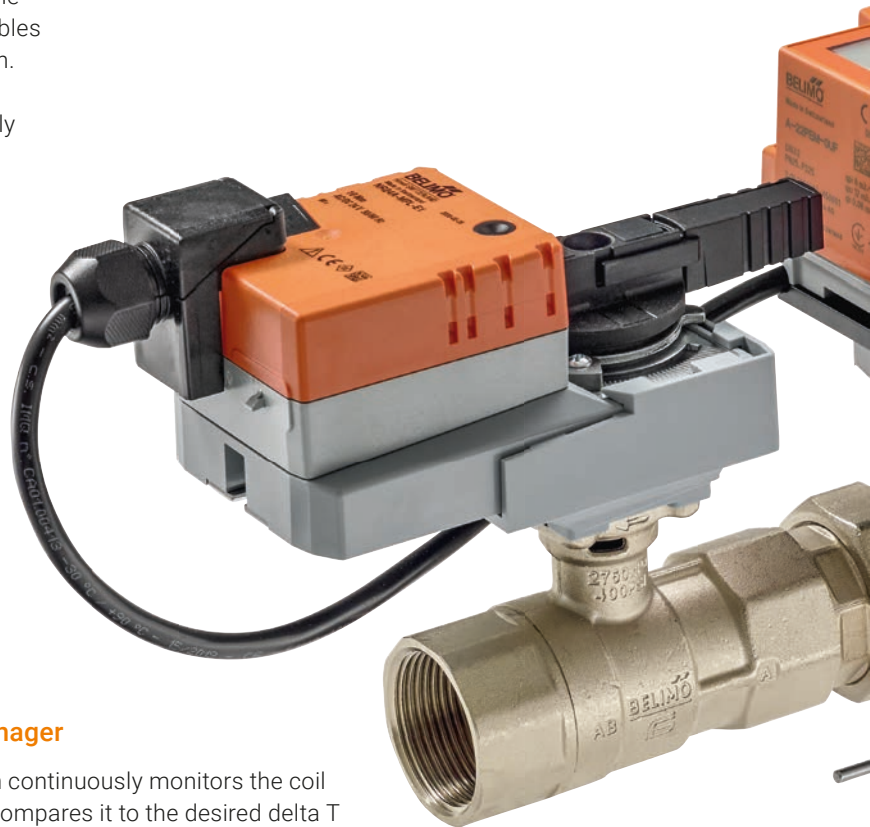

Simplified Troubleshooting

The on-board web server provides statuses for the connected temperature sensors, the flow sensor, and the actuator. It will even tell you if there is too much air in the water. The Energy Valve is also a useful tool for troubleshooting the overall system and provides information regarding flow, supply and return temperature, heating or cooling capacity, etc.

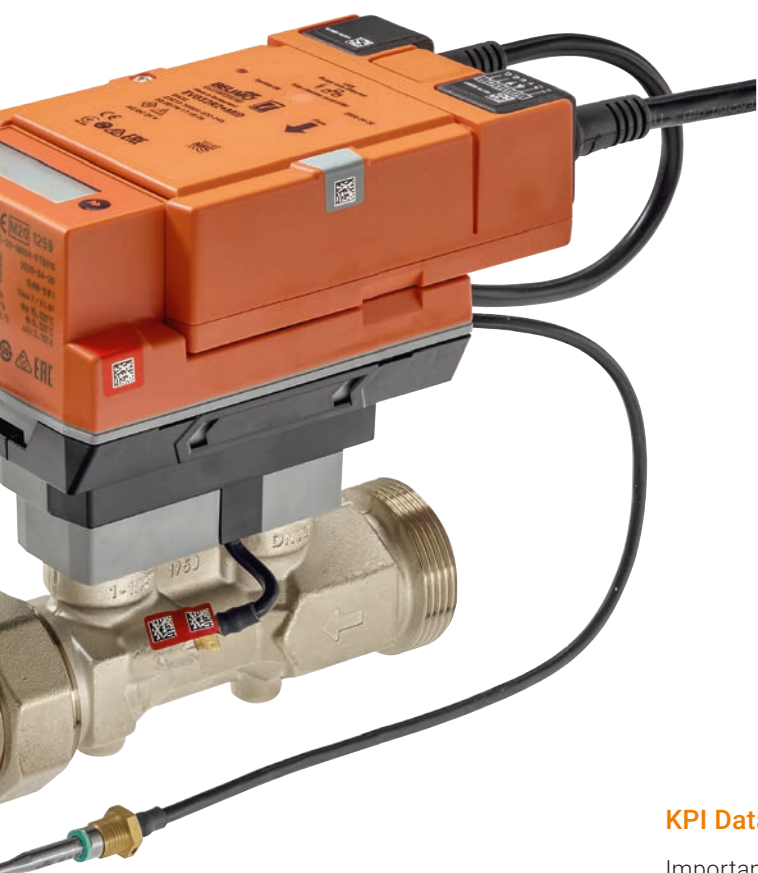

Startup Assistant

The Belimo Assistant App offers simple parametrisation, fast commissioning, and programming options.

Embedded Web Server

The embedded web server delivers a single, easy-to-understand point of access, which details the status of the valve, alarms and warnings. This makes the Belimo Energy Valve™ easy to set up, commission, and troubleshoot, even for non-technical personnel.

Delta T Optimisation and Flow Setpoints

Optional cloud analysis provides recommended delta T, flow and power setpoints that can be updated remotely or automatically to further improve energy efficiency. The data of the web server can be downloaded.

Performance reports

Key performance indicators are available on the web server and via the field bus and include current and historical power data. When connected to the cloud, a detailed report with the annual heat energy data is generated quarterly.

KPI Data

Important data such as delta T, flow rate, valve position, heat transfer, and thermal performance can be stored on the device for up to 13 months, and even for its lifetime if connected to the Belimo Cloud.

IoT-ready

By "opting in" on the web server and opening an outgoing port on your firewall, your Energy Valves can connect securely to the Belimo Cloud. Doing so offers a wealth of benefits, including product updates, online technical support, archiving of data, and the capability to use our expertise to check your current settings are optimal.

3.7 User benefits with Belimo Energy Valve™



Investors / end users

- Increase the energy efficiency of your building, reduce operating costs, increase the capital value of the building, and attract better rental yields.
- Ensure consistent comfort and the availability of peak energy performance of your plant all year round.
- Ensure that the hydronic circuits are correctly and continuously balanced and that tenant improvements or occupancy changes do not have a negative effect on comfort.
- Reduce the operating costs of pumps and chillers/heaters by increasing the efficiency of the system and preventing operation in the loss range.
- Make informed decisions about upgrading or replacing equipment based on historical data stored on the Energy Valve or in the cloud.
- Get the most out of your current plant. Eliminating low delta T syndrome ensures that reported capacity problems are not a result of overflowing coils or "ghost energy".
- Showcase your building by utilising state-of-the-art technology.



Consulting engineers

- Provide your clients with an industry-leading product, proven to save energy and provide valuable insight into the operation of the building.
- Offer continuous commissioning with minimal costs.
- Perform remote flow verification by checking 100% of the Energy Valves installed in a building in the time it would take to check a single valve.
- Ensure hydronic balancing under all operating conditions.
- Simplify troubleshooting with 13 months of stored data and an easy-to-use Excel tool for visualising it.
- Ensure full system capacity at peak times and achieve savings for the rest of the year by preventing operation with excessively low temperature spreads.
- Remove the usual 10% commissioning tolerance and reduce pipe work and unnecessary pump head.
- Provide your clients with a product that has an industry-leading warranty, with service and support available around the globe.



Installer/Mechanical Contractor

- Save material and labour costs with the Belimo Energy Valve™, which integrates a control valve, a balancing valve, an actuator, and an energy meter.
- Reduce the time for water-side commissioning by using a valve that measures the water flow for you.
- Reduce the risk of late handover by using the possibility of using simple tools to check flow rates earlier in the project.
- Solve problems and simplify troubleshooting with on-board diagnostic tools.
- Offer your customers a reliable product with an industry-leading warranty for complete peace of mind.
- Simplify glycol dosing by using the integrated glycol monitoring of the Energy Valve. This eliminates the risk of overdosing, saves chemical costs, and enables the pump's peak performance and efficiency to be maintained.
- The support engineers at Belimo are always at hand when you bring your Energy Valve online. Remote support to help maintain the product throughout its life is just a few clicks away.



System integrators and control contactors

- Provide transparent systems that allow full visualisation of energy consumption, through a single, easy-to-integrate device.
- Solve your customers' problems with low delta T, reduce the operating costs of their pumps, and free up plant capacity – all while maintaining comfort.
- Reduce installation time and complexity by combining several units into one. Commissioning is quick and easy with the help of the setup help.
- Easily investigate and troubleshoot local problems with on-board diagnostics, and system-wide hydronic problems using data stored in the Energy Valve.
- Monitor glycol levels and report them on BMS.
- Determine the planned water flow rates and set up the system correctly, even when no design data are available.
- The Energy Valve delivers ideal information for your cloud analytics platform to make better customer recommendations, thus increasing savings and value for your customers.



Energy Service Company

- Provide a reliable and proven way to save substantial energy in an HVAC system, with a relatively low initial investment.
- Save your customers utility and energy costs and penalties due to low delta T values below the agreed level.
- Make use of the recommended delta T and flow setpoints via cloud connection, to save time and to improve efficiency.
- Provide advanced solutions for clients incorporating cloud-based analytics, to benchmark and optimise system performance.
- Obtain graphically illustrated performance reports from each Energy Valve with current and historical data on flow rates, energy consumption, delta T, and other relevant data.



Facility Manager

- Areas with no flow or insufficient pressures are easily identified before occupant comfort is compromised.
- Use the data available on the Belimo Energy Valve™ to identify, diagnose, and resolve complex and often intermittent problems.
- Monitor glycol content to maintain the correct glycol concentration and improve overall heat transfer pump efficiency.
- Reduce operating costs for pumps and chillers/boilers by increasing the efficiency of the system.
- Provide reliable operation and occupant comfort.
- Ensure coils are dynamically balanced to offer true flow control.
- The integrated web server allows easy troubleshooting to find problems with valves or equipment based on 13 months of installed data.
- Quickly and easily check the performance of the heating or cooling system by reporting back the actual flow rate of the Energy Valves, either directly or via the BMS.

4

Control Modes of the Belimo Energy Valve™

The Belimo Energy Valve™ offers various control modes. These can be selected during commissioning and changed at any time in the valve's setting function.

4.1 Position control

In this mode, the control signal is converted directly into a valve position. This is equivalent to pressure-dependent operation as with a conventional valve. This should be used only in very specific situations:

- During adjustment, in which a base flow must be determined
- To determine the optimum operating point of the heat exchanger(s) served by the valve
- To establish flow over a particular period of time, to evaluate energy savings achievable when flow control is enabled

Why use this?

For benchmarking if you want to determine the savings that the Energy Valve will provide. For example, during commissioning you can compare the energy consumption of the system in position control mode with the consumption in power control mode.

What is required at the valve?

The Energy Valve is delivered from the factory in flow control mode. To enable position control, a change in the settings is required. The position control is not pressure-independent and should be used only for short periods of time.

Figure 22 shows an equal-percentage characteristic curve (blue line), and the other lines above represent control distortions that can occur when the valve is left in position control. Energy Valves are physically characterised by an equal percentage curve. However, in position control mode, the valve is not pressure-independent and will most likely experience a change in the valve characteristic curve due to valve authority as shown in the diagram.



Abb. 22: The distortion of the characteristic curve that could occur if the valve is left in position control.

4.2 Flow control

The Belimo Energy Valve™ interprets the flow control signal as a flow setpoint. The valve modulates to maintain the required flow, making the physical position of the valve dependent on flow and current pressure conditions. The desired flow rate is automatically maintained.

Flow control is a control algorithm that establishes a defined relationship between the control signal and the flow. The Energy Valve interprets the control signal as 0 to 100% of the specified flow through the Energy Valve. The control is pressure-independent in flow control mode.

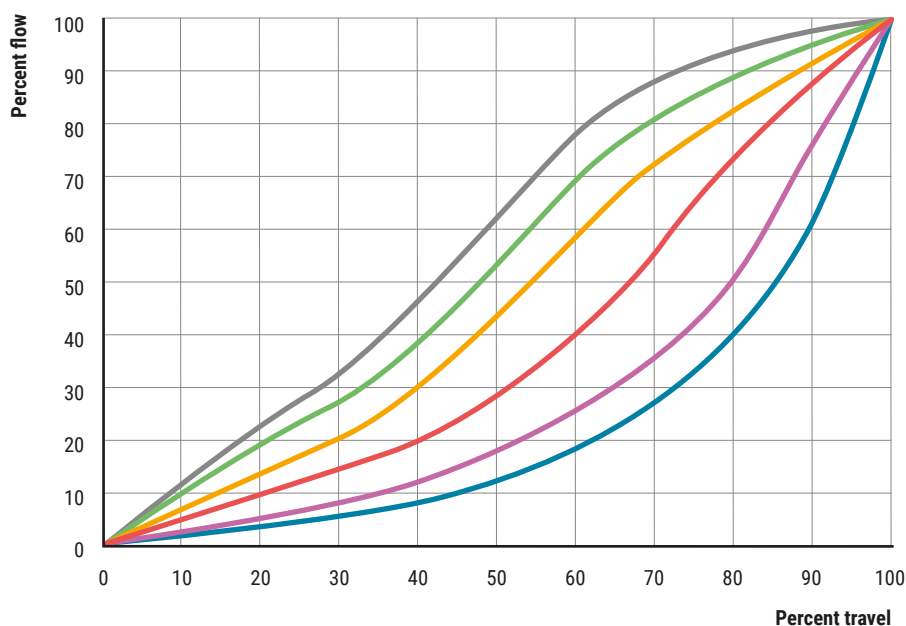
What is required at the valve?

Design flow rate – This is the maximum permissible flow rate of the valve, also referred to as **V'max**. This value should match the design flow rate value of the coil.

Figure 23 shows the characteristic curves typically available for PI valves and the relationship between flow and control signal. Figure 24 shows the control characteristics and how the valve keeps the correct flow constant within the tolerance across the entire pressure range.



Abb. 23: Flow characteristic in relation to the flow control signal.

→ Pro Tip

V'nom is the maximum flow through the valve, and V'max is design setting. The required maximum flow in the application (V'max) must be less than the catalogue value V'nom.

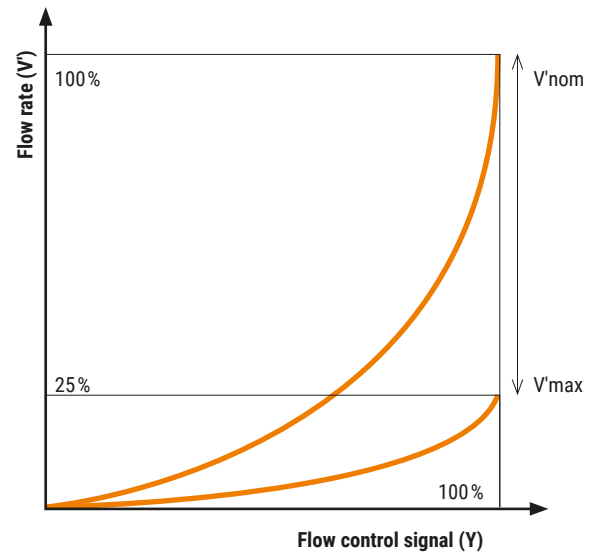

Abb. 24: Control characteristics in flow control mode.

4.3 Power control

The power control is a control algorithm that creates a linear relationship between the control signal and the power output. The Belimo Energy Valve™ interprets the control signal in 0-100% as the required power output at the consumer. Power control outperforms flow control because the function is not affected by air volume, water temperature changes or the characteristics of the heat exchanger. Power control is the only method that provides a truly linear relationship between control signal and heating or cooling output.

This feature uniquely allows variable flow temperatures in buildings that would not normally be able to utilise this function. If, for example, in a cooling application, there is a room that needs to be controlled very precisely, then there usually will be a time delay before the local flow control signal zone controller reacts when the water supply temperature rises. When power control is activated, the Energy Valve reacts much faster to a rise in supply temperature than the flow control signal, so that the required performance is maintained and, if activated, the delta T manager prevents a low delta T.

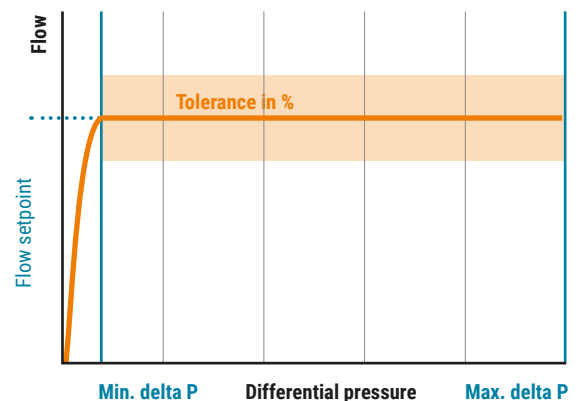
Why use this?

Being both temperature and pressure independent, power control offers a control stability not previously seen from a control valve. Heat exchanger power output remains constant despite changes in the variables on which the heat exchange formula is based. Ideally, you should use power control everywhere, but it is particularly useful for temperature-critical or performance-critical applications for which a variable supply temperature would otherwise not be suitable.

What is required at the valve?

The following information needs to be considered:

Design flow rate ($V'max$) – this is the maximum flow rate the valve will allow. Maximum flow limiting is still active in power control mode.

Maximum design power ($P'max$) – this is the maximum power the valve will allow.



Abb. 25: Power control of the energy input to a consumer.



Abb. 26: Control characteristics in power control mode.

→ Pro Tip

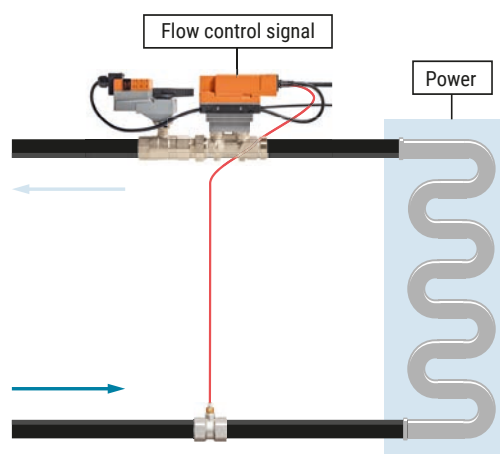
Use the digital settings in the Energy Valve's web interface to set the power control and to adjust or limit the coil's power. Use the analogue input signal to vary the power between the minimum and maximum of the control signal. Uniquely, you can reduce the maximum power output from the coil if

required. You can limit the power or give preference to certain areas.

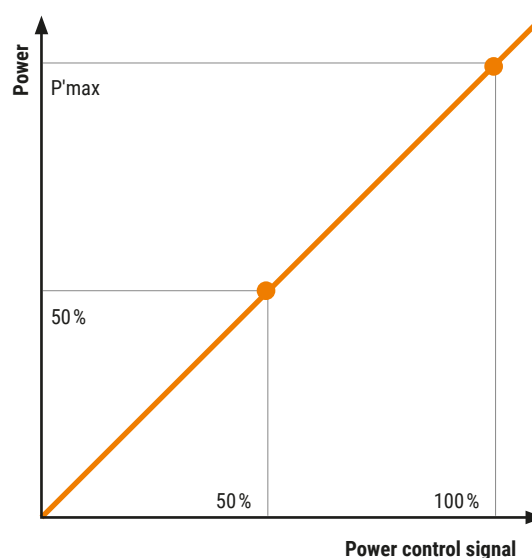
Example of a coil using power control

Figure 27 shows an example of a 293 kW air handling unit to be monitored. Here it is easy to understand the linearity of power control. If you require 293 kW, which represents 100% of the coil power, then that means that 10 V or 100% of the control signal is required. If the required power now changes to 30%, this means 88 kW and the required control signal is 3 V.

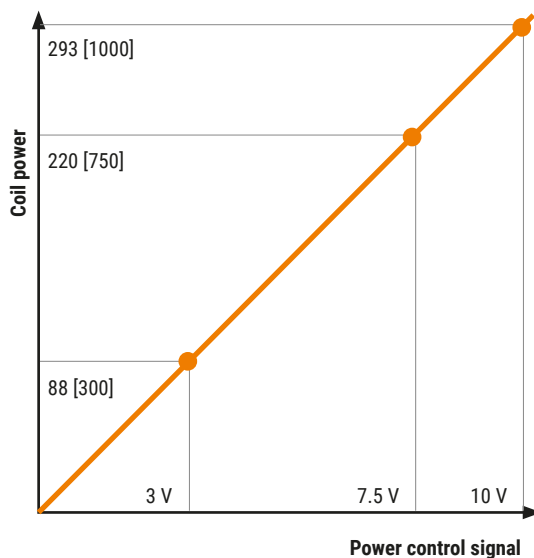

Example: AHU power

83 tons ~ 293 kW ~ [1000 kBTU/h] coil

3 VDC = 88 kW ~ [300 kBTU/h] output

7.5 VDC = 220 kW ~ [750 kBTU/h] output

10 VDC = 293 kW ~ [1000 kBTU/h] output (P_{max})

Abb. 27: Example of a coil using power control mode.

4.4 Delta T manager

The Delta T Manager monitors the delta T across the coil. When the delta T drops below the setpoint, the delta T manager logic throttles the valve position for lower flow, to increase delta T closer to the setpoint. The Energy Valve therefore offers a simple-to-understand method of reducing flows when the water is moving too quickly in order to enable optimum heat transfer.

Why use this?

This mode reduces high flows through your heat exchangers in situations where the delta T of a heat exchanger falls below the required setpoint. The delta T manager is best used for fixed supply temperatures. If you vary your water temperature, you should consider using delta T scaling (see chapter 4.5).

What is required at the valve?

The following information needs to be considered:

V_{max} – the design flow of the heat exchanger device.

Delta T limit value – this is the ideal differential temperature between supply and return.

Example of fixed delta T setpoint operation

The diagrams in Figures 28-30 explain the function of the delta T manager on a valve controlling a cooling coil. The blue line represents the cooling demand and the flow setpoint comes from the flow control signal. The green line is the measured delta T from the coils supply and return temperature. The black line is the desired delta T value of 7.7 K.

When the delta T manager is active, the overflow situation with delta T below the setpoint is detected and the delta T manager takes control. Now, the Delta T Manager restricts the flow of the valve to keep the delta T from dropping below the setpoint, as shown by the solid red and green lines.

What does a low delta T do?

The excessive amount of water is conveyed by the pumps. The relationship between flow and power consumption is cubed, so a small flow saving equates to a big power saving.

Generation also benefits from the increased delta T. Due to an increased flow through the system, the delta T is too small, which leads to a lack of power at peak times.

Optimising with the active delta T manager via the heat exchangers increases the efficiency of the system.



Abb. 28: When the demand increases and the flow changes, the actual delta T starts to decrease.



Abb. 29: If the delta T manager was not active, the flow setpoint drives the demand so high that the delta T falls below the desired setpoint of 7.7 K.

→ Pro Tip

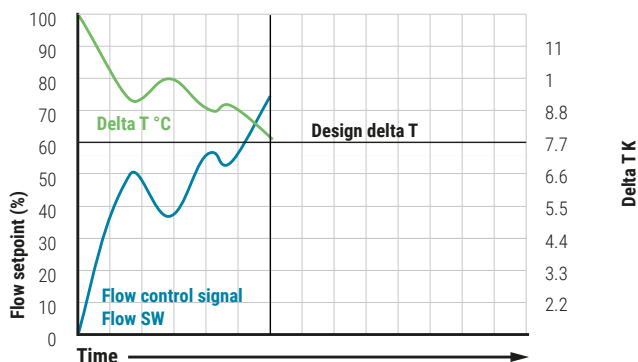
The Energy Valve will throttle the flow down only to 30% of the design flow. This ensures that, even after a downtime, the system will start up again without any problems. If required, the lower limit value of the monitored range can be set easily and quickly using the web server or the Belimo Assistant App.

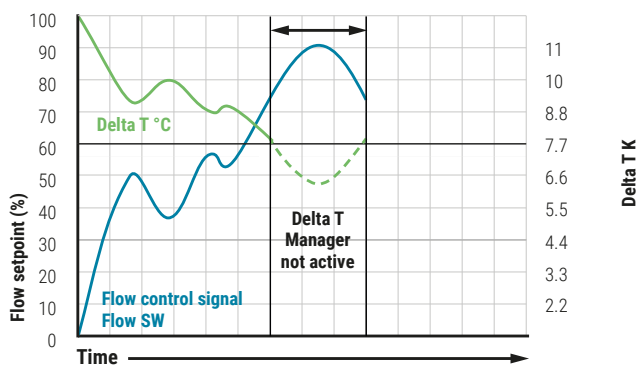

Abb. 30: The delta T manager detects a low delta T, becomes active, and reduces the flow to ensure the minimum delta T.

→ Case Study

The effect of the Delta T Manager

A case study was conducted in the HVAC facility of a global technology company to determine the effects of different Energy Valve control modes on the heat exchange process in an air handling unit (AHU) and their effects on energy consumption.

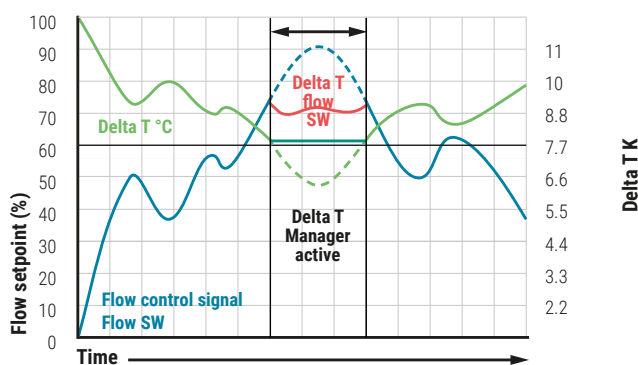
For a given power requirement to generate 211 kW cooling load at the AHU, the Energy Valve settings were varied as follows:

1. **Position control** - functions as a pressure-dependent ball valve. On average 54.5 m³/h to reach 211 kW.
2. **Flow control** - functions as an electronic pressure-independent valve. On average 32.7 m³/h to reach 211 kW.
3. **Flow control with delta T manager** - works like an electronic, pressure-independent valve with delta T limiting set to 9 K. On average, 21.8 m³/h to achieve the same load of 211 kW.

Figure 31 shows all operating points (delta T and thermal load) of the control valve in the three different control modes. After testing and collecting all the data for the generation of 211 kW cooling load, the results were as follows.

The conclusion of this study was as follows:

A closer look at the diagram shows that the Belimo Energy Valve™ with the delta T manager enabled requires around 2.5 times less water to achieve a cooling capacity of 211 kW compared to operation as a conventional control valve. The delta T value increased from about 3 K in conventional control mode to 9 K when the delta T manager was used. With the Belimo Energy Valve™, the performance of the ventilation unit can be optimised without compromising user comfort.

A 3rd party company was in charge of analysing the data collected during the pilot programme. Although use of the Belimo Energy Valve™ has yielded tremendous energy and cost savings of potentially \$1.5 million per annum, the real lesson of this particular test was how the valve could be used as a preventive maintenance tool, and its importance in creating long-term sustainability.



Abb. 31: Operating conditions (delta T and load) of the valve in different control modes.

4.5 Delta T manager scaling

The scaling delta T manager provides an alternative to the fixed limit value delta T manager function explained in section 4.4.

This function automatically adjusts the delta T limit value to the operating conditions. The valve will allow lower waterside delta T at lower flows, enforcing stricter delta T as you get closer to design. The controlled delta T is no longer a single setpoint, but a band of possible delta T values, as shown in Figure 32.

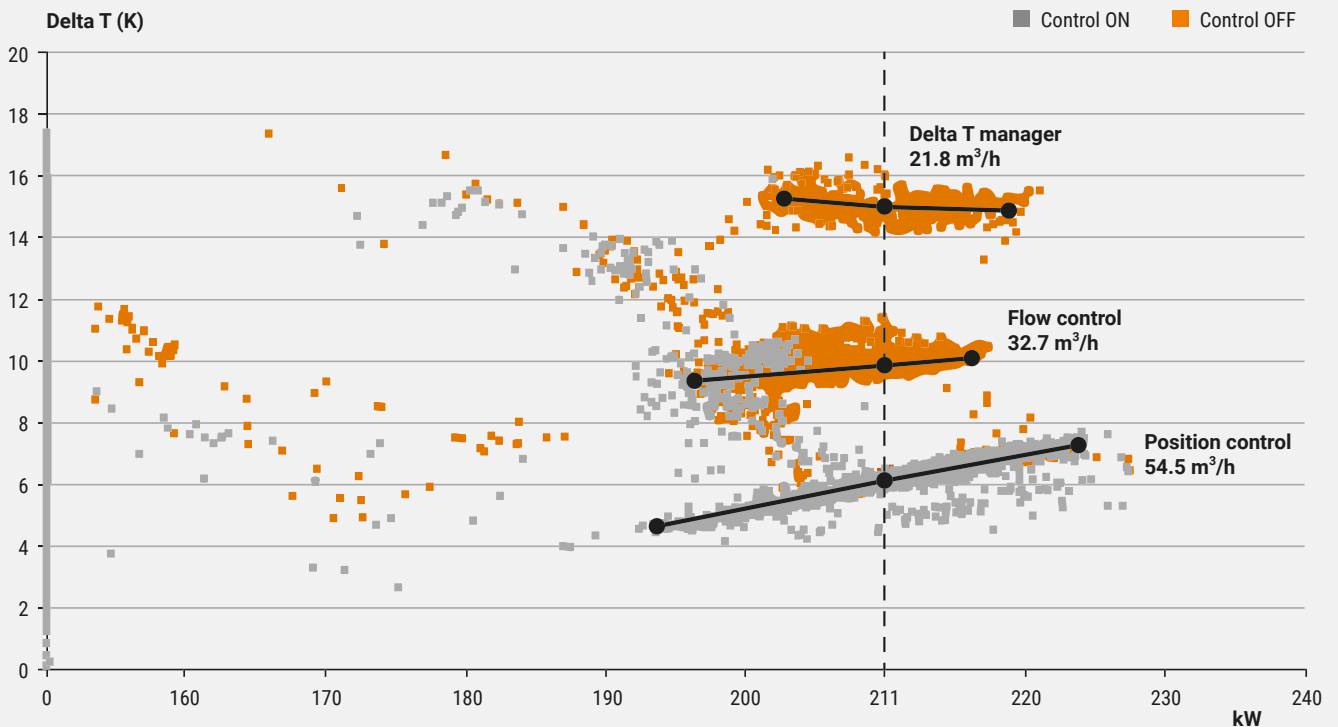
This band of delta T values illustrates the concept of scaling delta T. The flow that results in the coil/heat exchanger depends on the design. With changing inlet temperatures, flow limit is usually not sufficient and fluctuations occur in the system.

Why use this?

The higher the supply temperature (for cooling applications), the less energy the chiller needs to introduce into the water. This offers significant energy savings from the chiller. However, higher supply temperatures are closer to the entering air temperature of the heat exchangers, so the maximum possible energy transfer is reduced, therefore reducing the maximum delta T achievable from the heat exchanger. Delta T scaling helps to find the balance between economy at the plant during periods of low load, and ensuring delta T is maintained when loads are higher.

What is required at the valve?

Delta T flow saturation value – assuming that you are unlikely to have any design values, simply enter the planned flow.

Delta T limit value – this is the ideal differential temperature between supply and return at design flow.



Abb. 32: 'Scaling delta T manager' scales the delta T setpoint, depending on the current flow rate.



Pro Tip

If you want to adjust the supply temperatures to the demand when delta T scaling is activated, make sure you use the flow control signal to determine the demand, as all other variables are misleading.

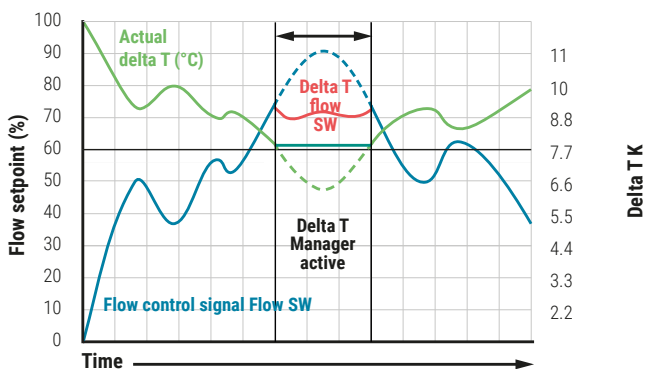
4.6 Control modes summary

Delta T manager

OFF

POSITION CONTROL

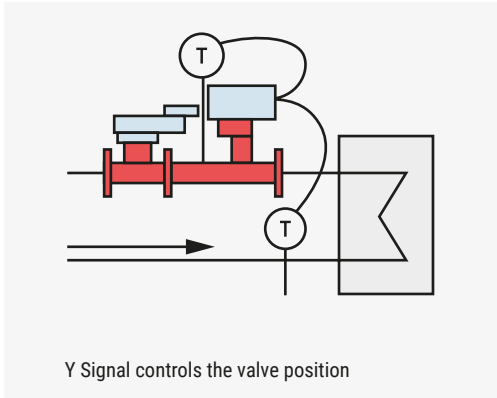

Position Control

The Energy Valve works as a normal pressure dependent valve. The actuator is positioned based on the flow control signal. Use this only for troubleshooting or benchmarking purposes.

FLOW RATE CONTROL

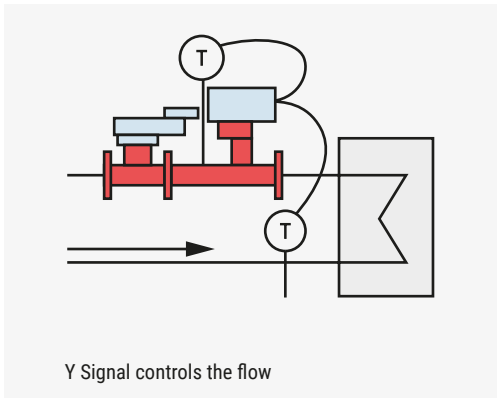

Pressure-Independent Flow Control

The Energy Valve works as an EPIV (Electronic Pressure-Independent Valve). The valve responds to all pressure changes and positions the actuator to maintain the flow setpoint based on the flow control signal.

POWER CONTROL

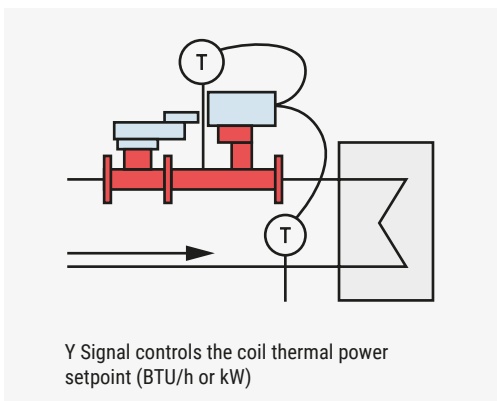

Power Control

The Energy Valve adjusts flow to maintain the thermal power setpoint. If the measured coil power is below setpoint, flow will be increased. If the measured coil power is above the setpoint, the flow will be decreased, as long as the defined V_{max} value is not exceeded.

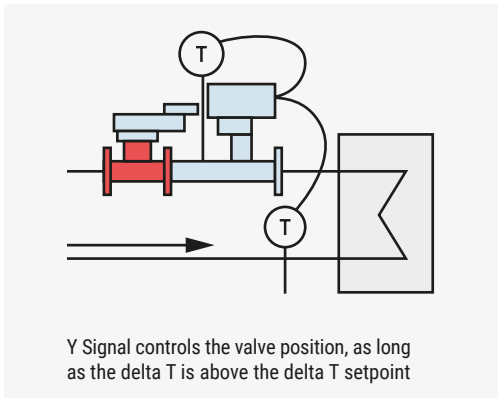
Delta T manager**ON****Position control and delta T manager**

The Energy Valve works as a pressure-dependent valve. If the measured delta T is lower than the delta T setpoint, the flow will be reduced by the Delta T Manager logic to achieve the setpoint, regardless of the control signal Y.

Note: Only the delta T manager can be selected for position control. The scaled delta T manager is not available.

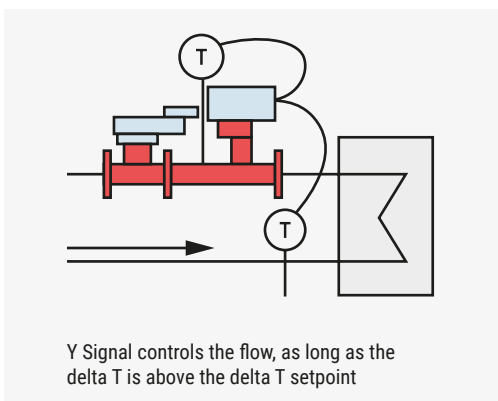
**Pressure-Independent Flow Control and Delta T Manager**

The Energy Valve works as an EPIV. However, if the measured delta T is lower than the delta T setpoint, the flow will be reduced by the Delta T Manager logic to achieve the delta T setpoint, regardless of the control signal Y.

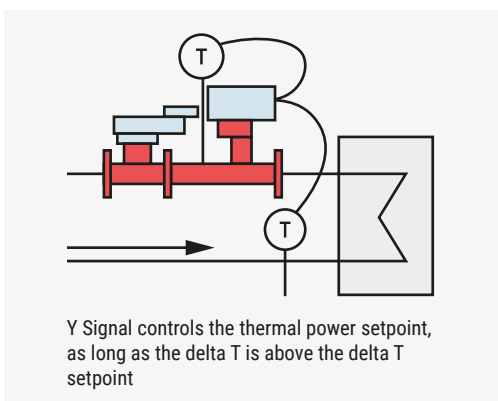
**Power Control and Delta T Manager**

The Energy Valve adjusts flow to maintain the thermal power setpoint. If the measured coil power is below setpoint, flow will be increased. If the measured coil power is above the setpoint, the flow will be decreased, as long as the defined V_{max} value is not exceeded. If the measured delta T is lower than the delta T setpoint, flow will be reduced by the Delta T Manager logic and this will override the thermal power control setpoint.

4.7 Belimo Energy Valve™ as an IoT device



A Belimo Energy Valve™ can be easily integrated into a BMS. The Energy Valve can also be connected with the Internet. By integrating the Energy Valve into the Belimo Cloud, users can create their own account and benefit from numerous free services. For example, you get full transparency about the energy consumption of the cooling and/or heating power supplied by the Energy Valve. Data is accessible from anywhere with an internet connection. Access to the Belimo online services also allows you to request the recommended individual settings for all the Energy Valves you own, and our servers base that recommendation on your valves individual historical data. As you'd expect, your data is encrypted and stored for the lifetime of the valve, or until you ask us for it to be removed.

The connection of the Belimo Energy Valve™ to the Belimo Cloud offers many advantages.



Abb. 33: Simple login procedure to the Belimo Cloud and access to the Energy Valve digital platform.



Your data, where you want them.

As your Energy Valve data are already securely uploaded to the Belimo Cloud, your other preferred cloud-based services can be given permission to access your data stored at Belimo. We are working with hundreds of organisations, big and small, to ensure it's easy for them to make use of your data, should you request it.

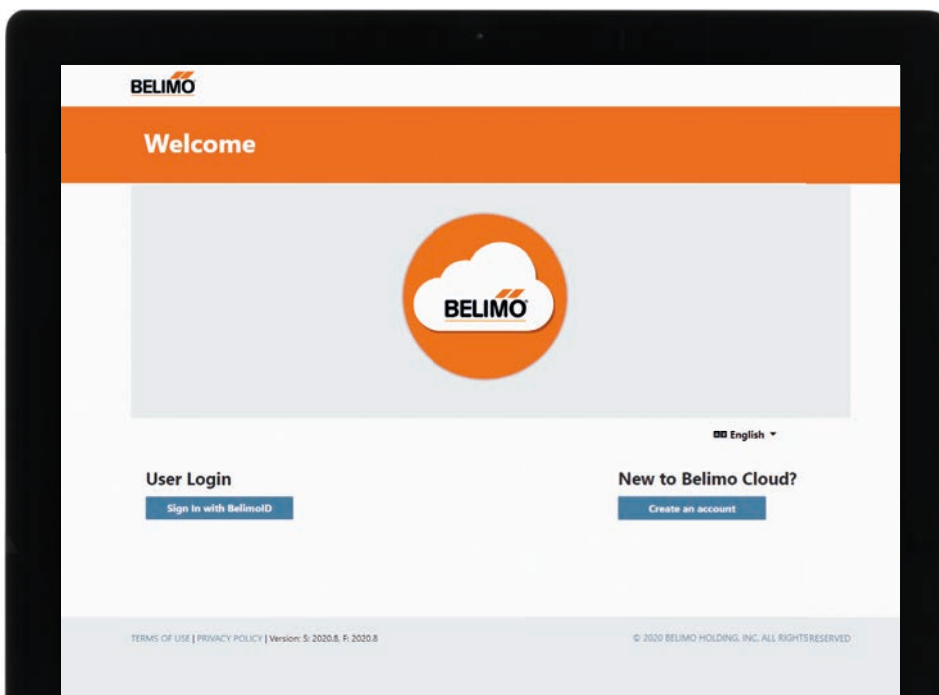

Optimisation of delta T and flow settings.

The data stored in the Belimo Cloud can be used to determine optimal flow and delta T setpoints, and can automatically set the valve for efficient operation or report the settings to the user. With the online form, as shown in Figure 34, the user can send a request to Belimo to optimise the delta T and flow settings.

Abb. 34: Online form to request the optimisation of delta T and flow settings.

Abb. 35: Once logged in, a series of services are available to the registered users.

BELIMO Overview Device Management Settings Support

Delta T Optimize Request

Delta T Optimize Request

Subject: Delta T Optimize Request

Device:

Usage: This device is used for both cooling and heating.

Updating: Manual Automatic

Information:
Request a device specific optimization for your Delta T settings. With the data of your device we will run an analysis and advise recommendations. Please select whether you'd like to set new Delta T values yourself manually or whether you would prefer to have them set automatically. Either way you will receive a notification by email after the data analysis is complete.

Please note that your device should report operational data for at least two months for a successful optimization and needs at least a connection ratio of 90%.

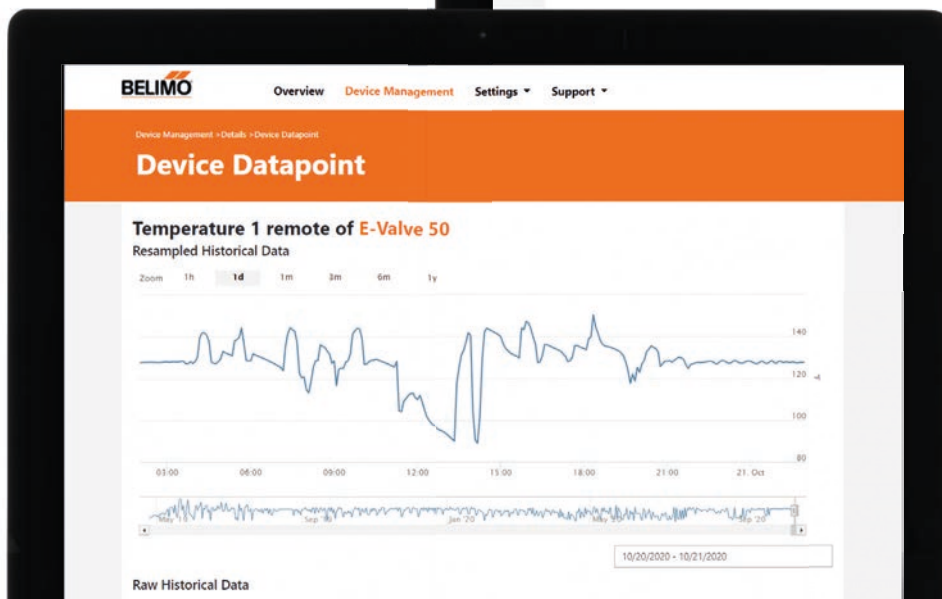



Performance reports

Upon request, a quarterly performance report is prepared and sent electronically to the owner of the Belimo Energy Valve™. The report contains important information about the operation of the Energy Valve. Energy usage and comparative analysis over previous years, along with operational data and possible errors in the system is included.

Online support

Being connected to the cloud gives the user the possibility to get online technical support, such as a personal live view of the valve operation and settings. Giving Belimo access to your data on a request-by-request basis allows quicker and more accurate diagnostics of the valve, and confirmation that the settings for the application are correct.

Belimo Energy Valve™
Performance Report

OVERVIEW

Reporting Period:	Q4, 2019
Name:	EV-AHU2_HKTC
Location:	Device location
Product:	NR24A-EV32A
Valve Size (DN-mm):	32
Report Generated On:	Jan 13, 2020 19:56

STATUS

The Energy Valve worked during the quarter, but warnings were reported. Read more about it on the second page.

CURRENT SETTINGS

Control Mode:	Flow
Override:	None
Maximum Flow (Vmax):	1.2 l/s
Installation Position:	Valve in return pipe
DeltaT Manager:	off

Please check out our [DeltaT Optimization service](#).

ENERGY PERFORMANCE

Total Energy Q1-Q4, 2019:	23'556 kWh
Total Energy Q1-Q4, 2018:	24'582 kWh
Cooling Energy Q4, 2019:	3'878 kWh
Heating Energy Q4, 2019:	2 kWh

Abb. 36: Example of a performance report of the Belimo Energy Valve™.



Software upgrades

Any firmware or software upgrades can be directly sent to the Belimo Energy Valve™. The settings allow for automatic download or notification with download on command. Just like your mobile phone, the Energy Valve can always be updated with the latest safety and performance improvements.

Increase warranty to 7 years

If an Energy Valve is online and connected to the Belimo Cloud, the warranty for that valve will automatically be increased from 5 years to 7 years.

Lifetime data access

With online Energy Valves, the most important operating data are stored permanently in the Belimo Cloud. On request of the owner of the valve, this data can also be deleted.

Abb. 37: Device overview (online) for technical remote control.



Abb. 38: Overview of the Energy Valves.



4.9 Energy Valve settings

	Position control	Flow control	Flow control DT fixed	Flow control DT scaling	Power control
V'max	–	Design flow rate	Design flow rate	Design flow rate	Design flow rate
P'max	–	–	–	–	Design power output
Delta T limit settings	–	–	Fixed	Scaled	Fixed
Delta T limit value	–	–	Calculated delta T for coil	Calculated delta T for coil	Calculated delta T for coil
Delta T flow saturation value	–	–	–	Flow rate in connection with the delta T limit value or design flow V'max	–
Influence of the valve	Pressure fluctuations will directly impact the flow through the valve	Despite pressure fluctuations in systems, this mode ensures the correct amount of water at all times, even in the partial load range.	Despite pressure fluctuations in systems, this mode ensures the correct amount of water at all times, even in the partial load range. In addition, compliance with a fixed minimum delta T is ensured.	Despite pressure fluctuations in systems, this mode ensures the correct amount of water at all times, even in the partial load range. Moreover, compliance with a minimum delta T under dynamic operating conditions is ensured.	In this mode, the valve regulates based on power output requirements, independent of pressure, flow, and temperature fluctuations.
Data collected	Real-time flow, temperatures, and power output	Real-time flow, temperatures, and power output	Real-time flow, temperatures, and power output	Real-time flow, temperatures, and power output	Real-time flow, temperatures, and power output

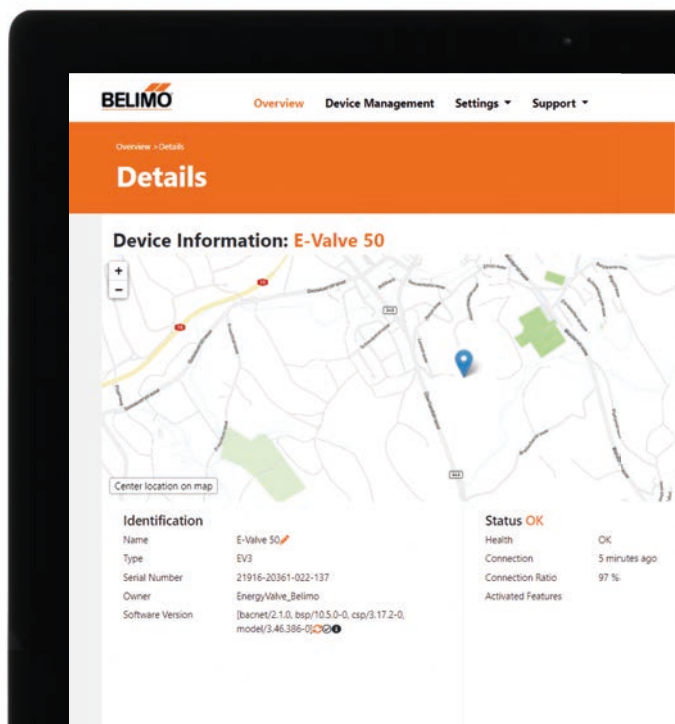
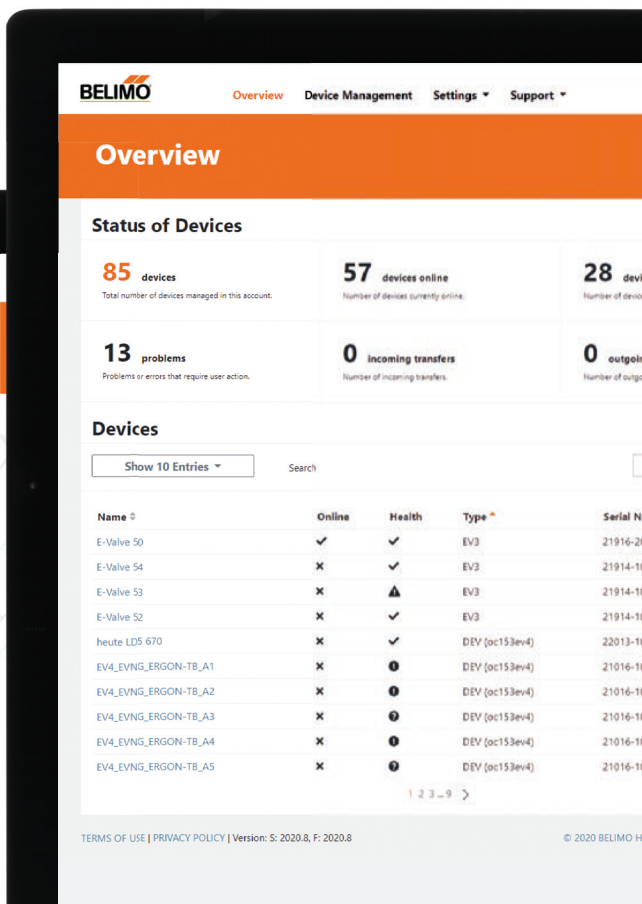
→ Pro Tip

Flow control already offers many advantages such as pressure independency.

You can take the control to the next level by using the power control. Energy valves are the only control valves that offer a truly linear response between flow, control signal, and heat exchange performance. You can go even further by selecting a delta T management option.

For existing buildings, it is recommended to operate the valve for a short period of time to collect data and determine the correct values for flow saturation and the new delta T values. Data collected during this period can be used to optimise coil performance.

4.10 Summary of features and benefits of the Energy Valve

Feature	Benefits
Air-bubble tight valve	Circulation and energy losses are prevented.
Self-cleaning ball valve	Excellent resistance to contamination and smooth operation even after a long time in closed position.
High resolution actuator	Improved controllability even at low load.
Pressure-independent	<ul style="list-style-type: none"> – Quick and safe valve selection according to flow rate – No calculation of flow coefficient (Cv/Kv) – Ideal room comfort due to the right flow rate at all times
Automatic and permanent hydronic balancing	Fast commissioning, no balancing valves or measuring stations needed.
Connection to the Belimo Cloud	<ul style="list-style-type: none"> – Delta T management by experts from Belimo – Transparency due to regular performance reports – Remote maintenance and diagnostics – Support via Belimo Cloud – Free software updates – Data storage over the entire life cycle – Extension of the warranty to 7 years
Compact size	Maximum efficiency in space and design freedom.
Variable V'max setting	Maximum flexibility in planning, installation, and accommodation.
Pressure independent flow rate due to dynamic balancing	Simple commissioning without time-consuming hydronic balancing.
Accurate flow measurement	Real-time flow-rate information.
Glycol Measurement	Continuous measurement provides certainty of glycol concentration <ul style="list-style-type: none"> – an interface to the BMS can be used for alerts in case of concentration deviations.
All-in-one solution	Five functions: Measurement, control, dynamic balancing, shut-off and energy monitoring.
Power control	Temperature and differential pressure-independent power control at a coil.
Delta T manager	<ul style="list-style-type: none"> – Prevents low delta T syndrome – Prevents an increased flow through the coil/ heat exchanger with a too-small delta T – Efficient operation of pumps and heat generator or chiller
Recording of all system data from the past 13 months	<ul style="list-style-type: none"> – Full system transparency shows potential for optimisation – Changes in system performance are detected – Helps preserve value of the entire system – Aids with system troubleshooting

A large grid of small dots, intended for taking notes. The grid consists of approximately 30 columns and 60 rows of dots, covering most of the page area.

NOTES



5

Feature overview of the new Belimo Energy Valve™

In 2021, Belimo launched a completely new generation (4) of Energy Valves in sizes DN 15 to DN 50. This new Energy Valve product range includes a certified thermal energy meter with a number of highly innovative features. The thermal energy meter also contains the logic for controlling the connected CCV valve, which is available both with and without fail-safe. The certified meters are also available as 'standalone' devices, without the valves.

5.1 Key features at a glance

Thermal energy meter

Certified energy metering with MID approval

The thermal energy meter meets the requirements of EN1434, and has type approval according to the European Measuring Instruments Directive 2014/32/EU (MI-004).



Energy cost billing

Thanks to compliance with EN 1434/MID, the meters can be used for billing energy consumption with tenants. This is mandatory in many countries.



Digitally supported workflows

The Belimo Assistant App guides you through the setup process.



Power over Ethernet (PoE)

The devices can be connected with one standard PoE/Ethernet cable that provides power and data transmission.



Simple integration

Using BACnet/IP and MS/TP or Modbus TCP and RTU, the thermal energy meter can be integrated directly into the building management system. No extra communication gateway is required.



IoT-based billing

Thanks to the integrated web server, the thermal energy meter can be securely connected to the Belimo Cloud. From there, authorised third-party billing platforms can access the available energy data and use it for tenant billing.



Belimo Energy Valve™ 4

Energy monitoring

The Energy Valve accurately measures and records the thermal energy supplied to the coil. The logged data helps identify optimisation potential.



Automatic balancing

Hydronic balancing is no longer needed, thanks to the pressure independent flow control of the valve.



Power control

By measuring the temperature and flow rate, the Energy Valve regulates the heating or cooling power supplied to a coil in accordance with the setpoint.



Delta T Management

An integrated logic prevents the occurrence of the low delta T syndrome and thus ensures maximum comfort with the lowest possible energy consumption.



Glycol measurement and compensation



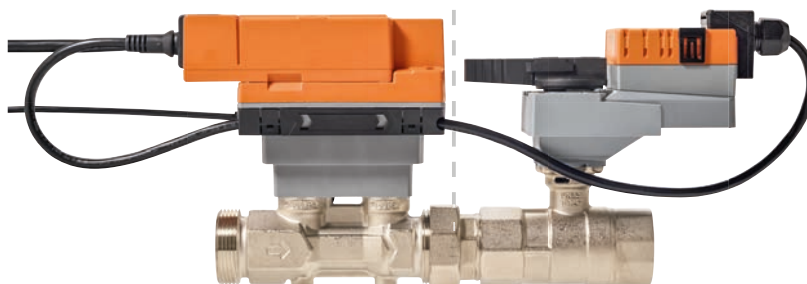

Belimo's patented glycol measurement and compensation guarantees precise energy measurement at all times. With MID certified heating power measurement, where glycol is not permitted, an alarm is triggered upon detection presence of glycol.



5.2 Generation overview

Since its release in 2013, the Energy Valve's functions and performance have been continuously expanded. The following table shows the development over time over four product generations.

Belimo Energy Valve™ generations

		1	2	3	4	
Release Date		2012	2014	2017	2021	
Internal thread	DN 15...50					
Flange	DN 65...150					
Control mode	Position	■	■	■	■	■
	Flow	■	■	■	■	■
	Power	■	■	■	■	■
Delta T manager	Fixed	■	■	■	■	■
	Scaled		■	■	■	■
Belimo cloud				■	■	■
NFC Assistant App						■
Glycol Measurement				■	■	■
MID Approval						■

5.3 Reliable certified metering, enabling IoT-based billing

High-quality measurement

Belimo thermal energy meters use ultrasonic time-of-flight technology, and are dirt-resistant, wear-free, and able to detect air in the water, as well as offering very precise measurement by using a fast measuring cycle. Our multi-point wet calibration of each individual meter during production ensures high accuracy across the entire flow measurement range.

Multi-application device

Belimo Thermal Energy Meters are designed as multi-application devices, i.e. they can be used as heat meters, cooling meters or combined heat/cooling meters. They can be installed either in the return or the supply of heat exchangers. The application and installation positions are made available to the valve during commissioning via a smartphone and the Belimo Assistant app or via a laptop and the integrated web server.

Certified energy metering

Belimo's certified thermal energy meter models meet the requirements of EN1434, and have type approval in accordance with the European Measuring Instruments Directive 2014/32/EU (MID). This certification is mandatory in many countries if the meter data are used for billing purposes. They provide validated data for billing purposes that can be used for direct billing. The thermal energy meters are approved according to MID for heat metering in pure water systems. Due to MID requirements, no glycol may be used in the system. Accordingly, an alarm is issued by the device if glycol is detected in the water.

Accurate thermal meters without certification

Glycol in a hydronic system can falsify the measurement of thermal energy by up to 30%. Meters from Belimo (non-MID version) offer the possibility of precisely measuring thermal energy quantities, even in hydronic systems with glycol. The glycol compensation automatically compensates the influence on the flow rate measurement. In addition, the substance data used for the output calculation are determined correctly at all times, thanks to the integrated glycol measurement.

Simplified energy billing

The thermal energy meters and the Belimo Energy Valve™ are designed for remote reading and IoT-based billing. Authorised users can access the measured energy data, either via the bus (BACnet, Modbus, MP-Bus or M-Bus) or via the meter's IoT interface in the Belimo Cloud. From there, the metering data can be made available to other authorised platforms. This gives building operators maximum flexibility in their choice of energy-billing service providers. These important data can be used for various other applications.

5.4 Digitally supported commissioning workflow

Simple commissioning and activation through NFC

The NFC interface (Near Field Communication) on the thermal energy meter enables easy commissioning, parametrisation, and maintenance via smartphone. With the Belimo Assistant App, devices can be configured intuitively, and the final configuration and activation is securely logged. Optionally, your smartphone can act as a gateway for the devices to the cloud, where the settings are stored for the entire life of the device. The key performance indicators (KPIs) of a meter or valve, which are also visible in the app, make it easier to determine the status of the device and thus ensure reliable operation in the long term.

Troubleshooting using NFC

Our devices provide numerous diagnostic parameters to the Assistant app via the NFC interface, so you can see how the app interacts with the system during operation. This makes it your tool of choice for troubleshooting. As an added benefit, you can get direct support for your device by using your smartphone to upload your devices' data to the cloud. With your permission, Belimo engineers can look at the data and help with your troubleshooting.

Connected, secured, and working for you – what a cloud connection can do

In addition to the usual integration of meters and Energy Valves into a BMS (via BACnet or Modbus), they can optionally be securely connected to the Belimo Cloud. The cloud connection offers access to all stored data as well as other functions to users who are authorised by the device owner. For example, when requested, our servers can analyse historical flow and temperature data for recommending the ideal delta T setting, allowing for an even more energy-efficient operation. Online software updates ensure that the device is always up-to-date and secure.

Modular design – makes re-calibration and replacement easy

The thermal energy meter consists of two main parts, the sensor module with the connected temperature sensors and the integrated calculator on the one hand, and the logic module with the NFC interface and all the connectors for the external power- and bus-wiring on the other.

The sensor module is available as a spare part and must be replaced periodically for recalibration in certain countries according to national regulations. When this is the case, only the lower sensor module needs to be replaced. The upper part with the complete electrical installation remains connected and no new integration work is required. This is a significant labour saving in the maintenance cycle of the meter.



Pro Tip

Should it be required, NFC can be permanently disabled.



Abb. 40: All wiring is to the logic module, allowing the EN1434/MID sensor module to be recalibrated without disturbing the wiring.

5.5 Seamless integration of metering data with a totally open approach

Easy integration to the BMS or metering systems

Connectivity has always been an important feature of our products. The Belimo Energy Valve™ and the thermal energy meter supports a number of building automation protocols (BACnet IP and MS/TP, Modbus TCP and RTU, Belimo MP-Bus, and M-Bus via a converter). Parallel operation of BACnet IP or Modbus TCP with M-Bus (with converter) is also possible. Bus communication can also be used for monitoring, controlling and even overriding when using an analogue signal to control the Belimo Energy Valve™.



Power over Ethernet (PoE)

The Belimo Energy Valve™ 4 and the thermal energy meter are the first Belimo products to offer PoE connectivity. This allows the device to be powered, and the data to be transmitted simultaneously with one single Ethernet cable. This simplifies installation, avoids wiring errors and eliminates the need for a local power supply.

Integration into any building IoT platform

Belimo's IoT-enabled products, such as the thermal energy meter and the Belimo Energy Valve™, can optionally be connected to the Belimo Cloud and from there to other authorised, third-party IoT platforms for buildings or energy analysis applications. You or your customers can benefit from the possibilities of a networked digital ecosystem.

- Take full control of your data
- Implement effective optimisation and energy saving strategies in buildings
- Reduced maintenance costs
- Always vendor independent, allowing you to select any BMS and energy billing providers, and change them later
- Transparency and secure data access throughout the entire life cycle

5.6 Available Belimo thermal energy meters

The new thermal energy meters from Belimo are currently available in sizes DN 15 to DN 50. Depending on the application and national regulations, MID-approved or non-MID-approved Thermal Energy Meters are available from Belimo. The energy meters with MID approval meet the requirements according to EN 1434 and have a type approval according to the European Measuring Instruments Directive 2014/32/EU (MID). This is mandatory for heating applications in many countries, ie. most of the member states of the EU, where the measured energy data is used for direct billing or heat cost allocation to tenants.

Thermal energy meters without MID approval can be used in all heating or cooling applications where no tenant billing is foreseen, or in countries where no mandatory codes on energy cost billing exist. This type of meter is particularly useful in cooling systems where the systems are to be operated at sub-zero temperatures, and therefore work with water-glycol mixtures. In this case, the thermal energy meters automatically and continuously measure the glycol content of the fluid, and compensate it to ensure that the thermal energy can always be measured reliably.



Abb. 41: Thermal energy meter from Belimo.

Available Belimo thermal energy meters

Version	Type code	Autom. glycol compensation	Glycol alarm	Approved according to EN1434/MID	Display	Nominal diameter DN	Nominal flow [m ³ /h]
With meter display	22PEM		■	■	■	15...50	1.5...15
Without meter display	22PE	■					

5.7 Total system optimisation with the Belimo Energy Valve™

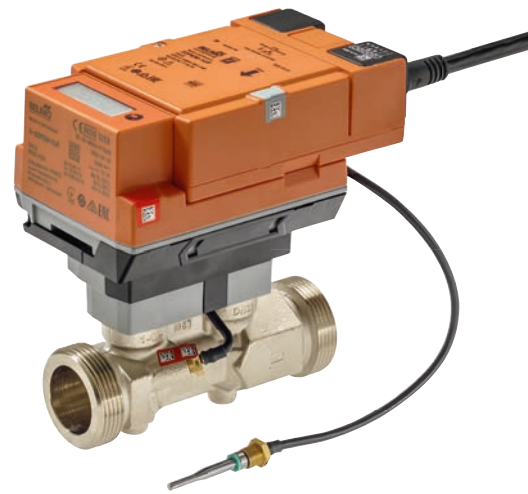
If you plan to use Energy Valves throughout the building, you will have a lot of data, and that data can be used to help provide building optimisation. With all the products on the market, it can often be challenging to design a holistic system that enables genuine energy savings. Several data points from the valves are required to use the energy-saving strategies described in this guide. Therefore, a bus connection is required and the implemented network should be able to deliver data to the building management technology in a timely manner.

Common Problem: Pump optimisation using mechanical PI valves

Mechanical PI valves have a regulator or diaphragm that alters the pressure drop across the valve. This constant adaptation of the valve Cv/ Kv ensures perfect valve authority, but also means that the valve positions are not related to the pressure drop of the circuit.

A typical solution involves using pressure sensors to control pump speeds, detection of pressure changes caused by movement in valves or diaphragms, and pump speeds altered accordingly. However, positioning of these sensors is troublesome. If the sensors are placed close to the pump, the decreasing pressure drop in the pipes is not taken into account during partial load operation. This results in too great an increase in pressure. When placing the sensors far away from the pump, the problem arises that the bad point in a system often shifts during partial load operation. Undersupply to consumers is possible.

Solution: Pump optimisation using electronic valves

As there is no diaphragm, the position of an electronic valve is an indication of flow and pressure. A valve with a small opening angle indicates that the differential pressure is higher than necessary. A valve in a fully open position is unable to satisfy the current flow requirement with the available pressure.

Since Energy Valves automatically compensate for excessive differential pressure across the valve, the system can be readily optimised. With the help of a BMS, which collects and checks all control signals from the Energy Valves, the line can be identified according to which the pump optimisation for the current operating point is to take place. For optimisation, the pump pressure can be reduced until the Energy Valve has typically reached an opening degree of 90%. Now the pump delivers just enough pressure so that the Energy Valve can also ensure the required amount of water at the bad point.

Now, if the bad point in a building changes, whether due to a change of season, changes or extensions to the hydronic system or the behavioural pattern of the occupants, you will be ready for it.



Abb. 42: An Energy Valve that does not meet its flow requirements and has insufficient differential pressure.



Abb. 43: An Energy Valve that meets its flow requirements and has a low differential pressure.



Abb. 44: An Energy Valve that meets its flow requirements and has a high differential pressure.

Problem: Secondary energy savings due to short circuit of the primary circuit by the hydronic deflector

Hydronic systems are often split into two, a primary circuit serving the main plant, and a secondary circuit that carries the energy out to the consumers. This is necessary because the heating/cooling system needs a minimum flow. If the secondary side flow is below the minimum flow of the



Abb. 45: The largest thermal load is at the valve with the widest opening.

primary side, the water flows via the hydronic deflector. Most modern systems are variable flow on both sides, however, legacy systems have a fixed speed primary. When a system is to be optimised, we often focus on the secondary part, but only optimising the primary part (i.e. in energy production) increases the efficiency of the system.

Possible solution: Monitor the flow through the hydronic deflector and the delta T of the primary part with an Energy Valve

By monitoring the flow over the hydronic deflector, the BMS can be programmed to prevent unwanted flows via the hydronic deflector. For example, you can allow the cold water reset to take the thermal index valve to 100% opening, or you can lock the index valve. You could even elect to overflow a number of valves to ensure the secondary flow remains above the primary minimum.

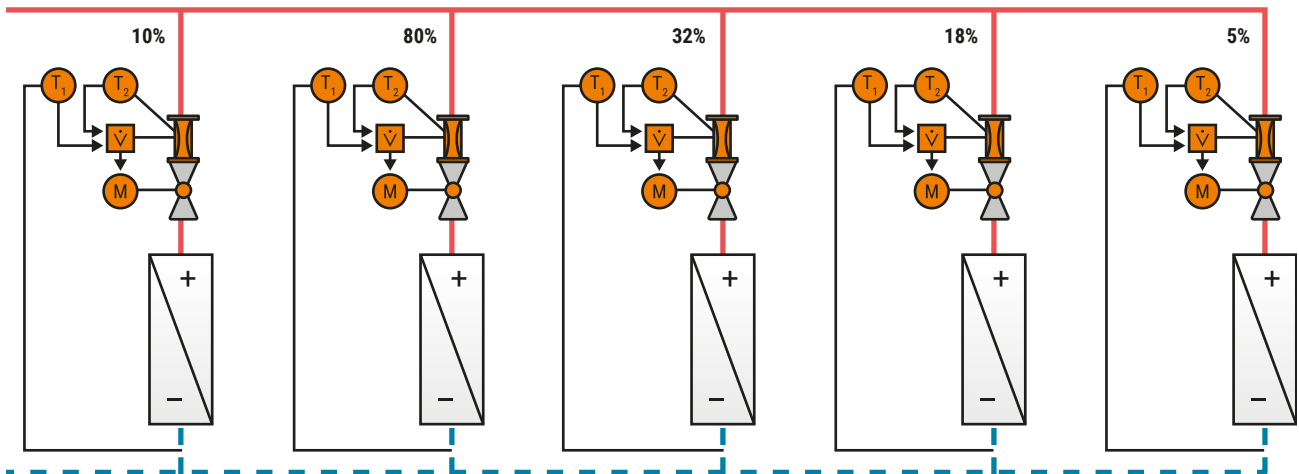
If there is a flow via the hydronic deflector when there should not be, an alarm can be sent so that the cause can be checked.



Abb. 46: Simple representation of a primary/secondary circuit with a hydronic deflector.



Abb. 47: An Energy Valve that monitors the temperature spread of the primary part and the flow via the hydronic deflector.

→ **Pro Tip**

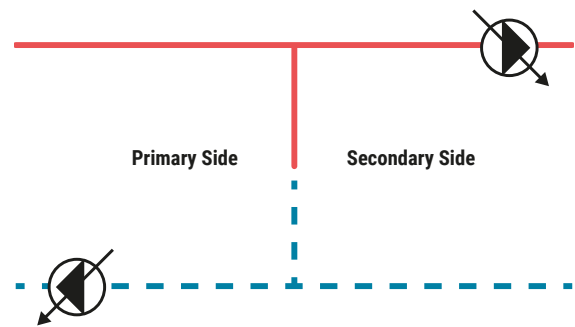
If your pipelines of the hydronic deflectors are very large, you can install a thermal energy meter in the secondary return. This is usually smaller in size. A control damper can be installed in the hydronic deflector. Most chillers report the flow through the meter so that the total flow can be compared with the secondary return. It requires a few separate components, and a bit more setup, but delivers significant energy savings.

5.8 Belimo Energy Valve™

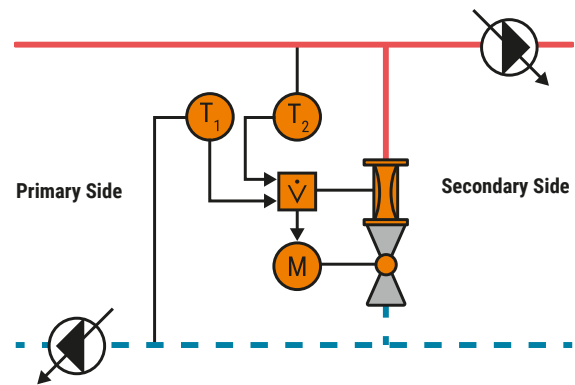
The new generation of Belimo Energy Valve™ 4 are currently available in sizes from DN15 (1/2") to DN50 (2"). For larger nominal diameters from DN 65 (2.5") to DN 150 (6"), the Energy Valve 3 is available. These offer the same basic functions such as electronic pressure-independent flow control, power control, delta T management, and IoT connectivity. There are product variants for 2-way or 3-way applications and with or without fail-safe. Depending on the desired application, the requirements according to EN 1434 are fulfilled thanks to a type approval according to the European Measuring Instruments Directive 2014/32/EU (MID). Glycol compensation ensures precise measurement at all times.



Abb. 48: The Belimo Energy Valve™ 4.

FEATURES

- Sensors for measuring the temperature spread, the flow rate, and thereby the power and the energy
- Regulation of the valve position, flow or power, for optimal operation of the heat exchanger
- Automatic compensation of differential pressure changes at full and partial load
- Absolute tightness in the closed position, thanks to ball-valve technology
- Ready for IOT-based billing
- Simple setup and parametrisation with the Belimo Assistant App
- Seamless integration in the building management system via bus communication
- Device can be powered and data can be transferred directly via an Ethernet cable (PoE)

Available Belimo Energy Valves™ 4

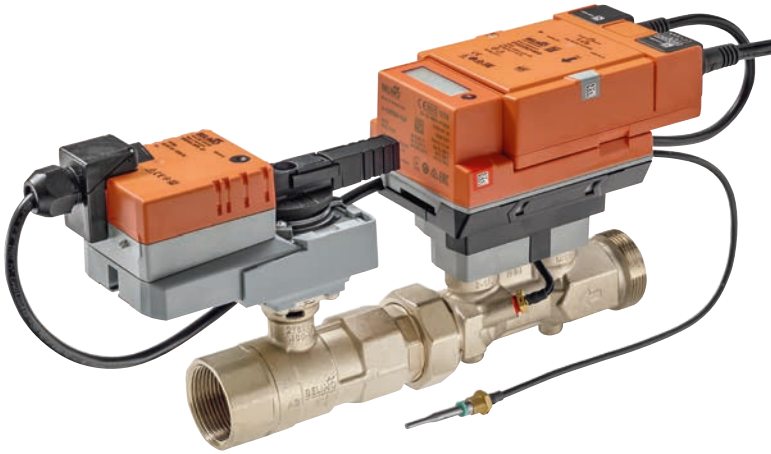
Version	Type code	Autom. glycol compensation	Glycol alarm	Approved according to EN1434/MID	Display	Nominal diameter DN	Adjustable flow V'max [l/min]
2-way	EV..R2+BAC	■				15...50	6.3...288
	EV..R2+KBAC	■					
	EV..R2+MID		■	■	■		
3-way	EV..R3+BAC	■					

Energy Valves sized DN65 to DN150 are available as Belimo Energy Valve™ 3

A large grid of small dots, intended for taking notes. The dots are arranged in a regular pattern across the page.

NOTES



PART B

Belimo Energy Valve™ HVAC Applications

Part B of this guide presents a selection of common HVAC applications where the Belimo Energy Valve™ comes into use. After a short description of each application, common reasons for poor efficiency or performance are identified. It explains how the Energy Valve can be used to address these problems and which control modes and settings are recommended for optimal performance.

Note that this application guide is only a general guide on using the Energy Valve and does not replace the work of a professional engineer.

Quick Selection of Valve Control Mode

Based on our application experience, we suggest setting your Belimo Energy Valve™ as shown in the table below. Details can be found in the examples on the following pages.

- INITIAL SETUP
- EXPERT CHOICE
- SELECTION
(if power demand is known)

CONTROL MODE		POSITION CONTROL	FLOW CONTROL	FLOW CONTROL WITH DELTA T MANAGER	FLOW CONTROL WITH DELTA T MANAGER	POWER CONTROL WITH DELTA T MANAGER	PAGE
1	Air handling unit		○			●	62
2	District heating or cooling/plate heat exchanger		○			●	70
3	Fan coil		○		●	■	76
4	Chilled beams		○		●	■	84
5	Heating/cooling changeover		○		●		90
6	Distribution and delta T management		○		●		94
7	Computer room air-conditioning unit		○			●	100
8	Central heating system	●					104
9	Monitoring chillers and heat pumps	●					110

1

Air handling unit

1.1 Application description

An air handling unit (often referred to as an AHU) is a machine used to prepare and circulate air as part of a heating, ventilation, and air-conditioning system. Ventilation and air conditioning systems significantly contribute to ensuring comfort in rooms and providing healthy air. In addition, sensitive processes and production facilities place high demands on the room climate and indoor air quality.

AHUs are at the heart of these systems. They provide the supply air in the required quantity and quality. An AHU may include the following air handling stages: Air delivery, filtration, heat recovery/cooling recovery, heating, cooling, humidification, and dehumidification.











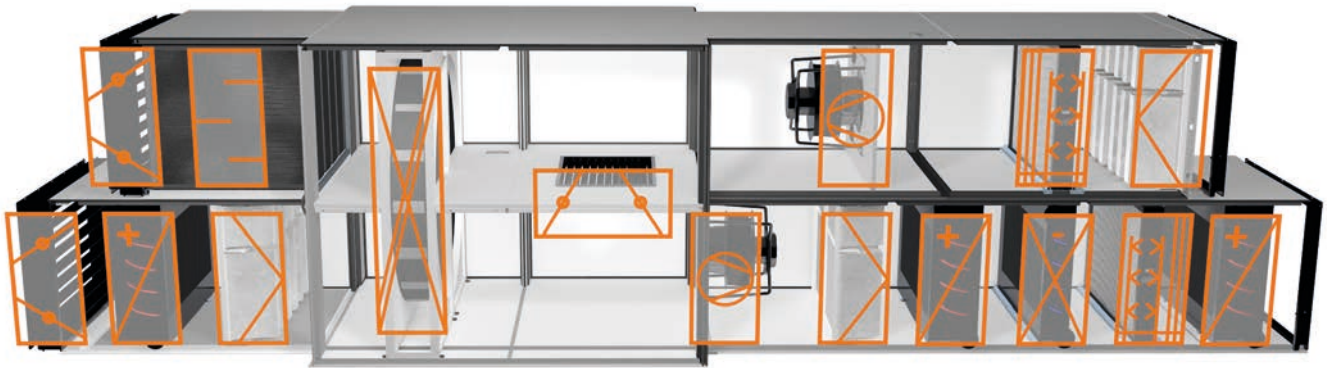

Abb. 49: Schematic of an air handling unit (AHU)

Icon	Job function	Component
	- Prevent entering outdoor air - Prevent damage when the system is switched off	Damper
	- Filter outdoor air - Filter supply air - Filter extract air	Air filter
	- Reduce sound distribution	Sound attenuator
	- Recover heat - Recover energy	Heat recovery system (HRS) Plate heat exchanger Rotary heat exchanger Run-around coil system
	- Add recirculation air	Damper

Icon	Job function	Component
	- Transport supply air - Transport extract air	Fan
	- Preheat outdoor air - Heat supply air - Reheat supply air	Heat exchanger Air heater
	- Cool supply air - Dehumidify supply air	Heat exchanger Air cooler
	- Humidify supply air	Humidifier
	- Adiabatic humidification and cooling of extract air	Humidifier

1.2 Common problems in ventilation and air-conditioning applications

In practice, many air handling units cannot ensure the desired air conditions in the building at all times. Furthermore, problems that arise during the operation of the ventilation and air-conditioning system lead to a deterioration in the efficiency of the overall system.

- Differential pressure fluctuations in the hydronic system lead to an unwanted change in the heating or cooling output. This in turn leads to discomfort in the areas supplied with air.
- Oversized or improperly balanced pressure-dependent valves lead to unstable control, as a slight valve movement leads to large changes in the output delivered.
- Reduced air volumes at partial load lead to water flow rates that are not matched to the heat exchanger characteristics.
- The performance of heat exchanger coils can decrease over time due to damage or contamination.
- Diverting circuits with 3-way valves cause water to flow directly from the supply to the return at zero or partial load. This has a negative effect on the differential temperature between the flow and return. This in turn has a negative effect on the efficiency of cooling or heating generation.

1.3 Applying the Belimo Energy Valve™

Problem: Differential pressure fluctuations in the hydronic system lead to an unwanted change in the heating or cooling output. This in turn leads to discomfort in the areas supplied with air.

During operation, the demand for cooling or heating power in a building changes frequently. As a rule, the maximum power according to which the system was designed is not required. However, hydronic balancing when using pressure-dependent valves is implemented precisely for this rarely occurring full-load case. The differential pressure ratios change in part-load operation. This is additionally reinforced by the reciprocal influence of the hydronic consumer circuits. This results in pressure fluctuations in the system, which can lead to performance fluctuations on the heat exchangers and thus to discomfort.

Solution: Dynamic balancing of the hydronic system.

By using the Belimo Energy Valve™, the flow through the valve is permanently measured and pressure fluctuations are compensated for immediately. This maintains the transfer behaviour of the heat exchanger at a constant level and makes hydronic balancing unnecessary. Belimo recommends using Energy Valves in all air heaters and air coolers in AHUs, as they can detect, display, and compensate for pressure fluctuations and temperature changes in the system.



Abb. 50: Dynamic balancing ensures an accurate flow rate.

Problem: Low delta T syndrome

If a heating or cooling system is operated with an excessively high water flow, this cannot be converted into a higher heating or cooling capacity. The carrier fluid cannot transfer the energy, resulting in a reduced delta T. This results in the low delta T syndrome, a clear indicator that too much water is being pumped in the system. Another negative effect is that too much pump current is needed and the efficiency of the system suffers as a result.

Solution: Delta T Manager

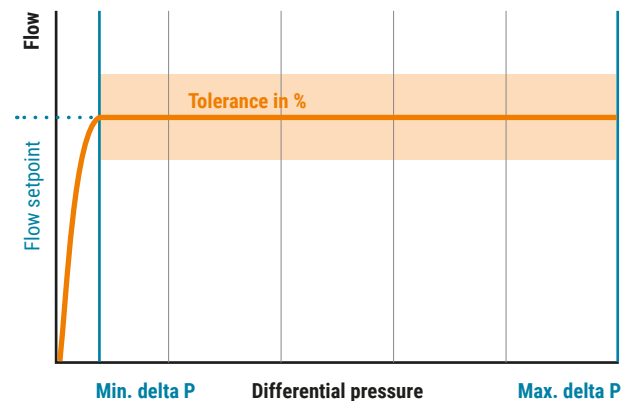
The delta T manager, integrated in the Belimo Energy Valve™, is a function that continuously measures the temperature spread and compares it with the system-specific limit value. If it falls below this, the Belimo Energy Valve™ automatically adjusts the flow so that only the amount of water actually needed to achieve the desired power is used. As a result, the integrated logic prevents the occurrence of low delta T syndrome and ensures maximum comfort with the lowest possible energy consumption.

Summary of the main Energy Valve benefits in an AHU application

- Dynamic balancing by the Belimo Energy Valve™ ensures the correct amount of water at full and partial load
- Reciprocal influence between valves is eliminated, due to the dynamic balancing
- The power control provides an identical heating or cooling output for each control signal
- The Energy Valve's monitoring functions provide full system transparency (flow, temperatures, heating or cooling capacity) with data recording and optional archiving in the Belimo Cloud
- Pump optimisation is possible via the valve position



Abb. 51: Low delta T syndrome



Abb. 52: Improved energy efficiency with the Energy Valve™ delta T manager enabled.

1.4 Application example

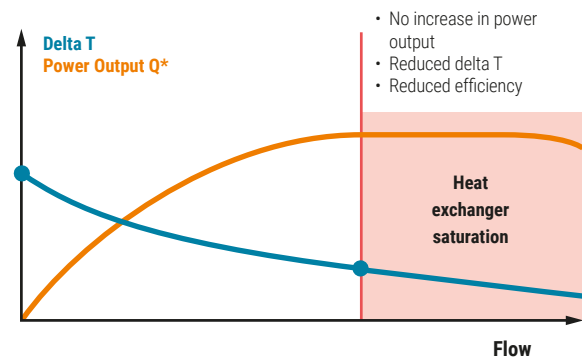
The indoor air system with variable air volume shown in Figure 53 supplies a number of VAV units with cooled air. Because of the high outside air temperature, a high air volume and a high cooling capacity are required. Accordingly, the water volume through the cooling coil controlled by the control valve is close to the design water volume.

Due to a decreasing cooling demand in the building, the VAV units reduce the air volume. This is done by reducing the damper position accordingly. The increasing static pressure leads to a reduction of the fan speed.

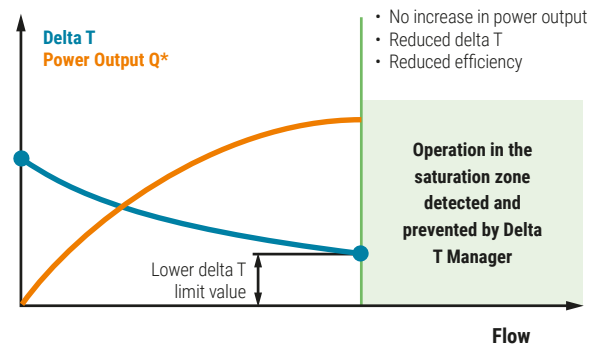
Fig. 54 shows how the flow across the valve increases to 3.5 l/s. This happens because heat exchanger valves in other air handling units close in the hydronic network and the pressure is distributed to other systems. The delta T of the heat exchanger drops to 2 K.

Fig. 55 shows the same AHU with an Energy Valve installed, which is operated at high outside air temperatures and thus drives the system close to the design values.

During the day, the AHU starts to handle the load in the room. The VAV units reduce their damper position and the fans reduce their speed, resulting in a reduction in requested power.

While the outside temperature is still high, the controller keeps the valve open and requires 3 l/s.



Abb. 53: AHU at design operation.



Abb. 54: AHU with valve overflowing.

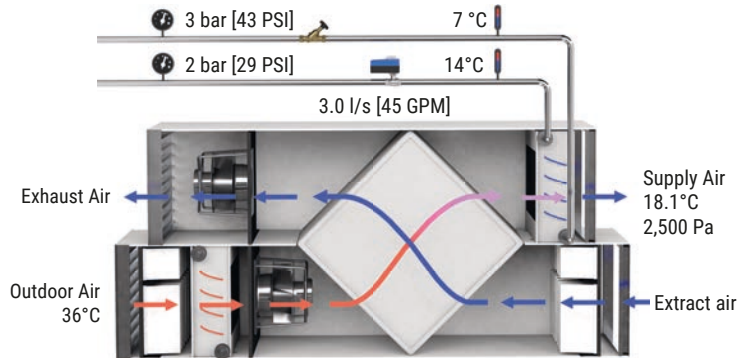

Abb. 55: AHU at design operation.

Fig. 56 now shows that the air volume requirement has decreased. This also reduces the need for cooling power. The delta T of the water circuit is now only 2 K. The flow rate of 2.7 l/s is still too high to increase the delta T to the design value of 7 K.

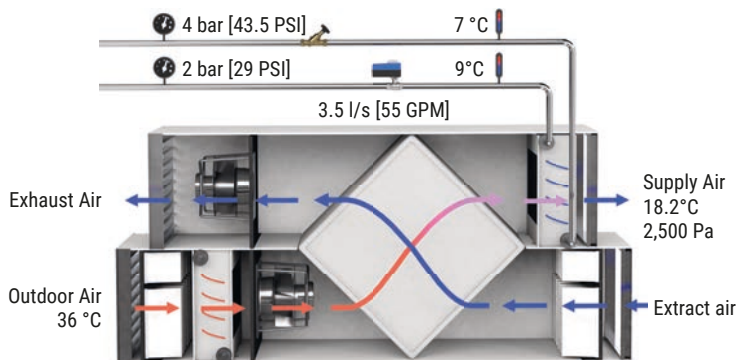
The built-in delta T manager of the Belimo Energy Valve™ detects that the delta T is too small and starts to close the valve to the preset value of 7 K.

As can be seen in Fig. 57, the delta T manager reduced the flow until the delta T of 7 K was reached. Now the heat exchanger only requires a flow of 0.8 l/s.

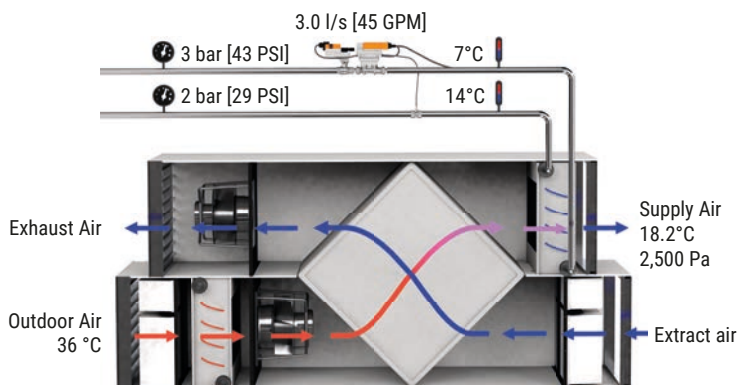

Abb. 56: AHU without valve overflow.



Abb. 57: AHU with delta-T-optimised flow rate.

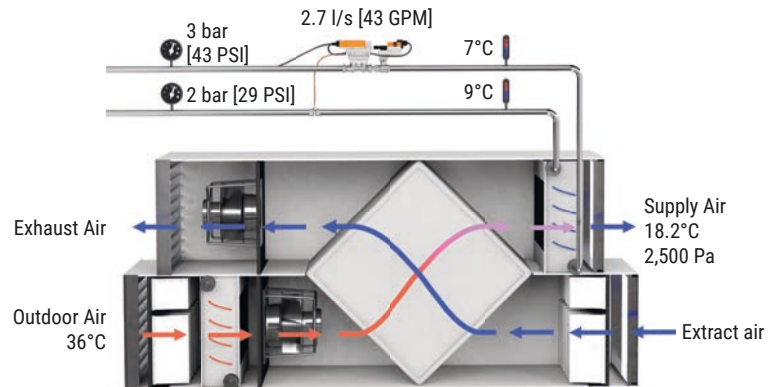

Pro Tip

The Energy Valve does not require the installation of control loops/control valves or additional temperature sensors and flow sensors – it is all included in a single product.

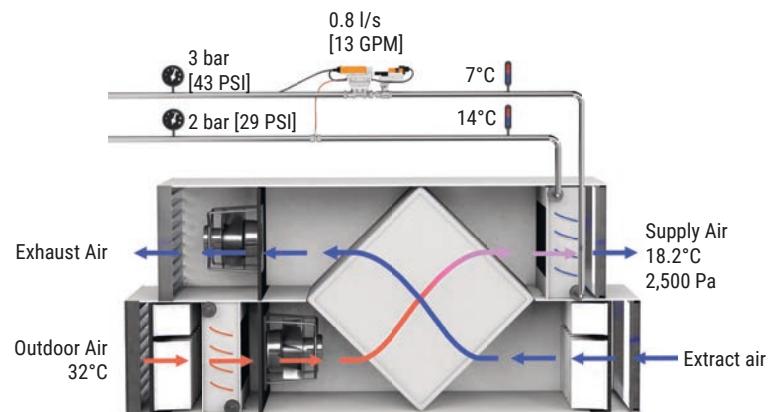
1.5 Success story

Belimo Energy Valves™ play an integral role in Land O'Lakes, Inc. corporate facility upgrade

Founded in 1921, Land O'Lakes, Inc. is one of America's premier member-owned cooperatives. Its members include 3,200 direct producers and 1,000 affiliated cooperatives, which together represent more than 300,000 agricultural producers in more than 60 countries.

The Land O'Lakes Inc. headquarters consists of several buildings, the two largest of which are a four-storey, 12,500 m² office building and a two-storey, 5,000 m² R&D building/analytical research laboratory. The two buildings, constructed in 1980, provide space for around 1,100 employees.

The majority of the headquarter's chilled water needs are handled by a single, closed loop that is driven by a central chilling plant. The plant has two 1 MW centrifugal chillers (2 MW in total). A total of six air handling units (AHUs) are responsible for handling the cooling load at the headquarters – four in the office building and two in the R&D building. When examining the operation of HVAC systems and equipment to identify where efficiency could be gained, Land O'Lakes, Inc. energy officials uncovered a costly problem in the cooling coils of the ventilation system. Much of the time, delta T across the coils was lower than its design specifications. In addition to increasing electricity costs due to over pumping, this resulted in sub-optimal heat transfer and significant inefficiency at the building level. After conducting a thorough review of piping, valves and instrumentation, officials concluded that in order to solve the problem, various infrastructural improvements would have to be made. They then began the process of searching for a solution, which eventually led them to the Belimo Energy Valve™.

Customer Requirements: Save energy, improve occupant comfort and enhance operational visibility

The following objectives were formulated for the retrofit:

1. Increase delta T in chilled water coils to their design specifications and achieve energy savings through increased pumping efficiency
2. Improve occupant comfort, particularly in the summer months
3. Gain visibility into the operation of air handlers and chilled water coils. In recent years, the chilling plant had been unable to adequately cool the facility. Energy officials at Land O'Lakes, Inc. wanted to determine if that was due to insufficient chilling capacity or inefficiency at the building level

The Solution: Belimo Energy Valve™

After various meetings with a Regional Application Consultant (RAC) of Belimo Americas, Land O'Lakes, Inc. made the decision to install Belimo Energy Valves™ on all six of the AHU's chilled water coils (AHU-1 through to AHU-6). These were to replace the outdated, pneumatic 3-way valves installed when the facilities were originally commissioned in 1980. As part of the project, all cooling coils in the ventilation systems were also replaced and improvements were made to the piping. New motors and frequency converters were added for more precise control of the chilled water circuit. Two Energy Valves were also installed on the heating coils to supply heat to the R&D buildings.



Abb. 58: Office building, retrofit and energy savings of 15%.

By installing the Energy Valves and improving the building infrastructure, the responsible persons at Land O'Lakes, Inc. aimed to have the temperature of the recirculated water deviate only slightly from the design temperature of the chillers. In doing so, the amount of flow required to provide cooling to the building would be substantially reduced, and energy consumption at the central chilled water plant could be decreased. In addition, the responsible employees use the diagnostic capability of the Energy Valve to gain improved insight into the operation of the cooling system and, in particular, to determine the specific power per ventilation system.

Results

The supply of cold water via the Energy Valves was monitored over a period of 31 days. The corresponding data were recorded for the numerical evaluation of the impact on the chilled water system.

To summarise, the data collected from the six Belimo Energy Valves included in this study indicate a potential flow saving of 6,210,964 gallons of pumped water over the time period, from June to August. Measurements also show that the valves had increased delta T closer to the design specifications of the chilled water plant, resulting in optimal heat transfer and more efficient chiller operation. In previous years, the lowest extract air temperature that could be

achieved in the facility was approximately 14.5 °C. After the Energy Valves were installed, discharge air temperature as low as 11°C was observed.

Benefits

- Increased pumping efficiency and reduced energy consumption. Land O'Lakes, Inc. was able to achieve an average of 15 percent less kiloWatt usage in July and August.
- The intelligent use of Energy Valve feedback data to control pumps with variable frequency drives allowed for more precise control of the cold water circuit without compromising the cooling capacity of the air-conditioning units during peak periods.
- Diagnostic capabilities allowed for visibility into individual buildings and cooling coil performance, which helped make projections regarding future energy consumption.

→ Pro Tip

With the setting of delta T scaling for the delta T manager, the designed flow, V'max, can be entered at the point "DT flow saturation value".



Abb. 59: Land O'Lakes retrofit project infographic.

2

**District heating or
cooling / plate heat
exchanger**

2.1 Application description

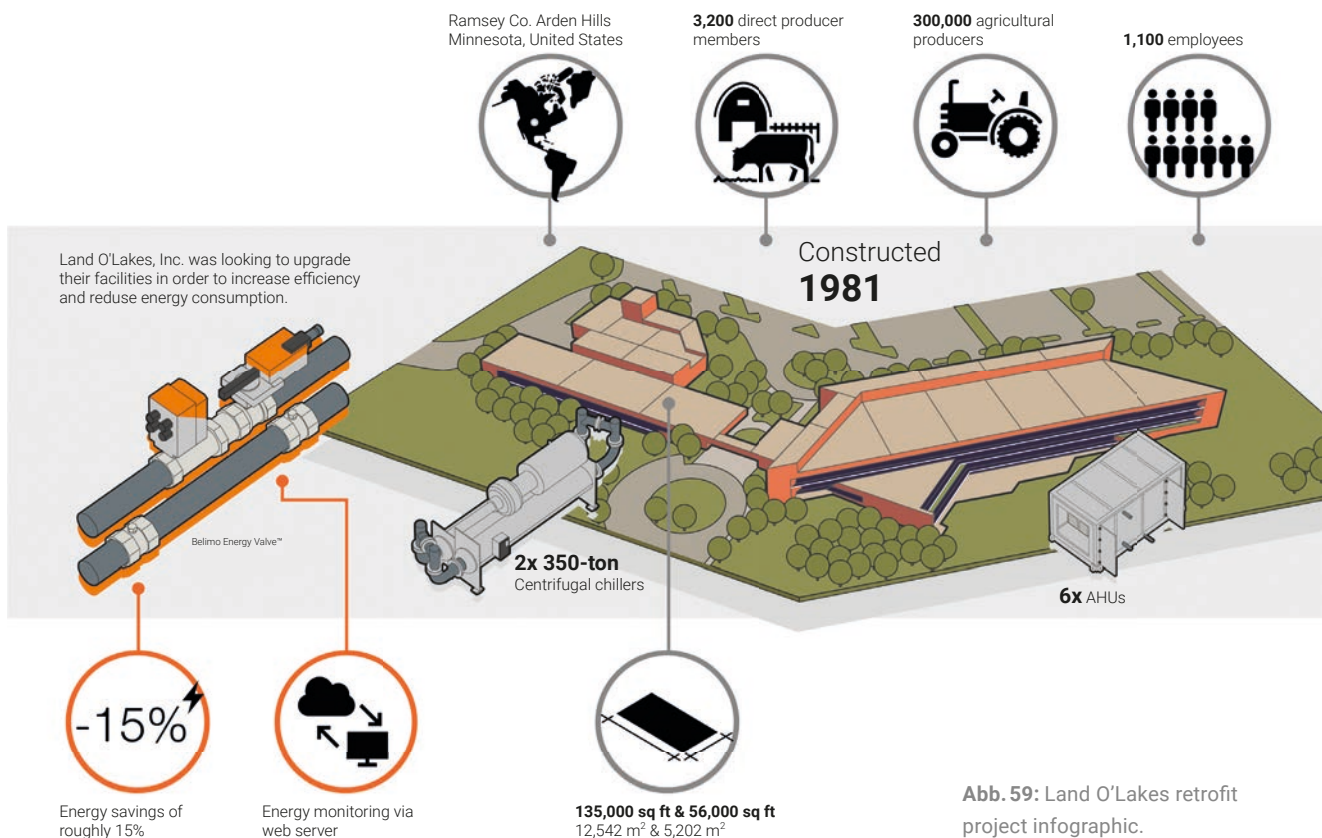
Plate heat exchangers are often used to separate primary and secondary circuits in HVAC systems. Those circuits may have different medium or static pressure conditions. Flow can take place in direct flow or contraflow. Heat exchangers are extensively deployed in tall buildings to reduce the gravitational pressures provided by large water columns. Plate heat exchangers are also very common in district heating and cooling, or in load circuits, to heat potable hot water with a boiler.



Abb. 60: Heat exchange station

2.2 Schematic



Abb. 61: Supply side (green) and consumer side (blue).

2.3 Common issues in buildings, and how the Belimo Energy Valve™ addresses them

Problem: Incorrect direction of flow through heat exchangers

Sometimes flow directions through the heat exchangers have not been chosen correctly, as shown in Figure 62. As a consequence, the heat transfer capacity is reduced.

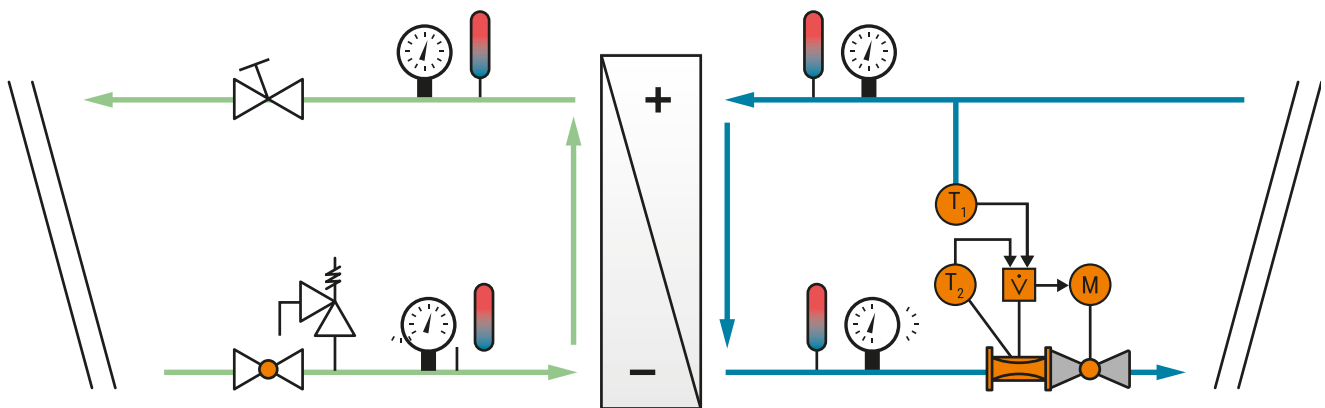
Solution: Contraflow design

The two figures below show two possible flow installations, while the contraflow setup shows much better heat transfer. It results in larger delta T, and therefore higher energy efficiency, as shown in Figure 64.

The Energy Valve is able to recognise false flow directions. If this is detected, an alarm will be sent to the BMS, and this can be discovered during commissioning.



Abb. 62: Cooling transfer station connected in direct current.



Abb. 64: Cooling transfer station connected in contraflow.

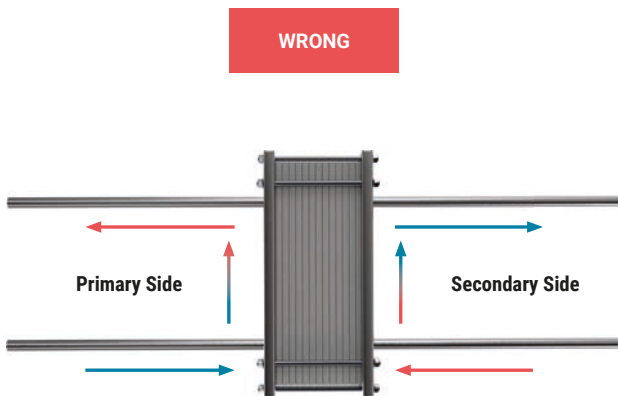

Abb. 63: $\Delta\theta_m$ average differential temperature for direct flow.

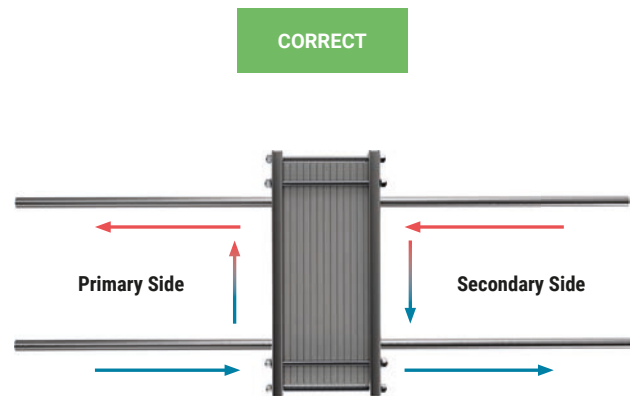

Abb. 65: $\Delta\theta_m$ average differential temperature with contraflow.

Typical design problem: Low transmission power and low delta T syndrome

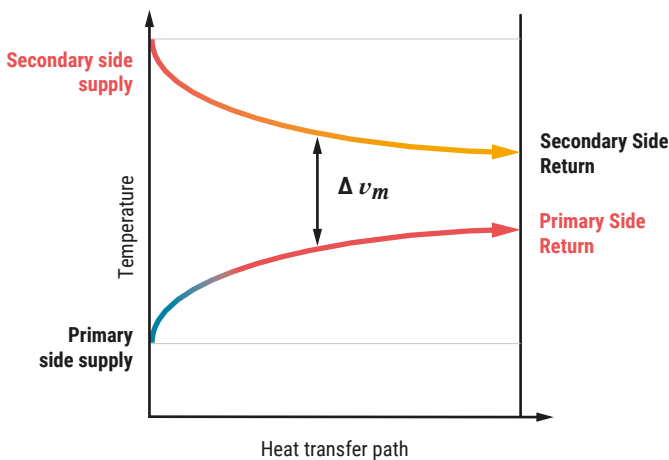
A traditional setup plate heat exchanger will have an energy meter and a conventional balancing valve controlling the maximum flow through the heat exchanger.

However, as Figures 66 and 68 show, pressure fluctuations on the primary side lead to oversaturation of the heat exchanger, resulting in a low delta T and a lower heat exchange performance.

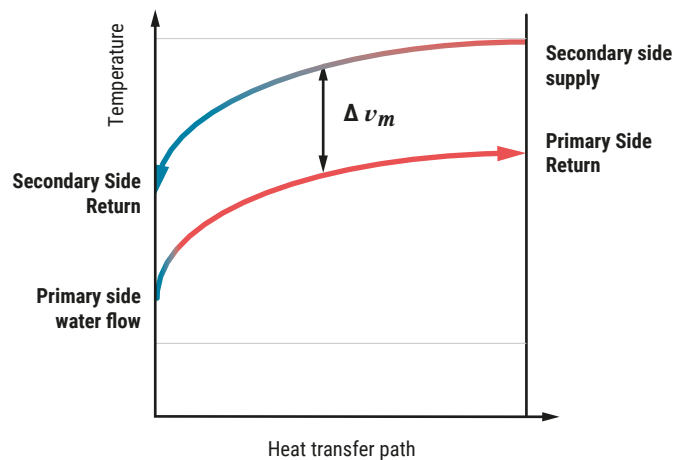

Abb. 66: Typical design flow (cooling application).



Abb. 68: Overflow caused by pressure fluctuations.

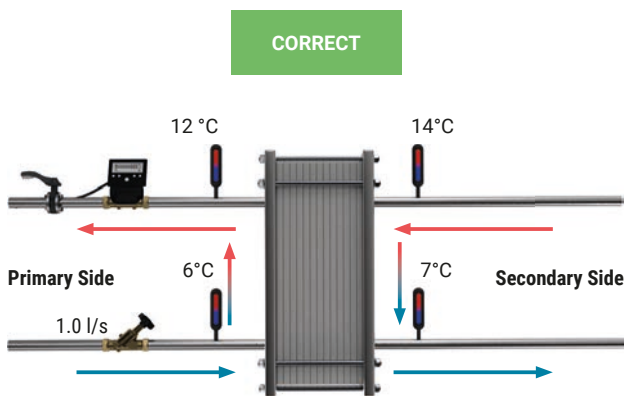

Abb. 67: $\Delta\vartheta_m$ average differential temperature with design flow.

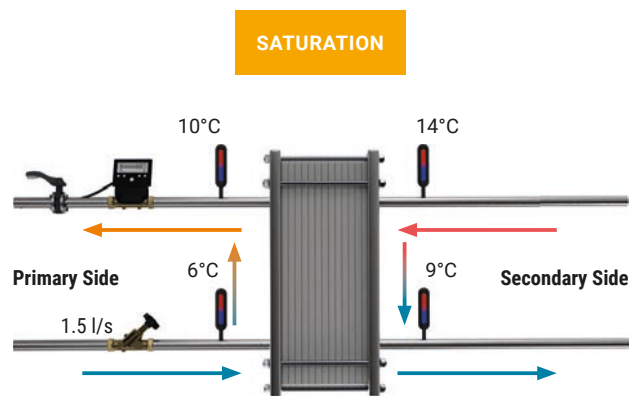

Abb. 69: $\Delta\vartheta_m$ mean differential temperature with saturation.

Possible solution: Dynamic balancing

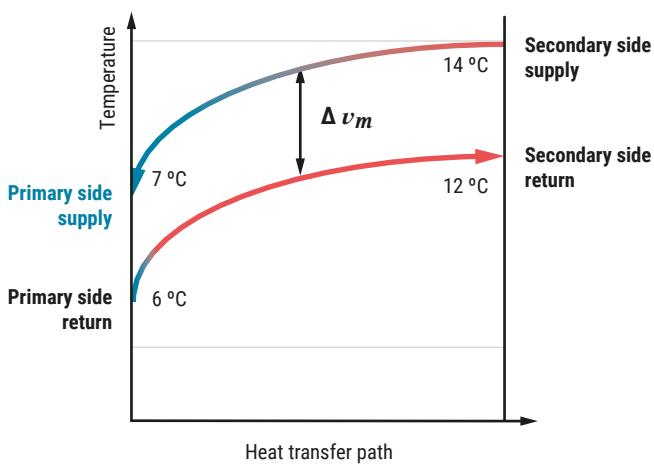
By replacing the traditional balancing and control valve with a pressure-independent valve, we solve the problem of pressure fluctuations in the system. This is a step forward, but still requires the use of multiple devices, including a separate thermal energy meter, as shown in Figure 70.

Better solution: Dynamic balancing with delta T monitoring

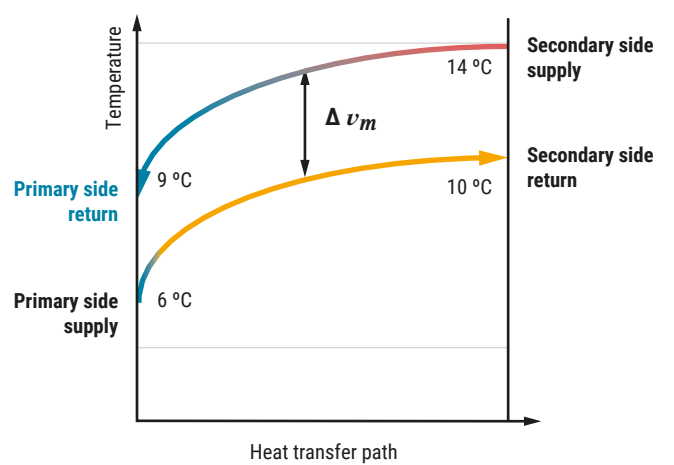
As shown in Figure 71, we use a single Energy Valve to dynamically balance the system, monitor energy consumption for billing, and record the delta T achieved.

This reduces the number of devices to be installed and simplifies the installation.

Problem: Fouling and deteriorating delta T

Most heat exchangers suffer from fouling on one or both sides of the circuits. Minor contamination on one side impairs the thermal energy transfer and reduces the delta T.

Solution

The heat exchanger characteristics can be displayed with the aid of the data recorded by the Energy Valve. A change in this characteristic over time can now be detected easily and quickly. Appropriate measures can be taken to maintain energy efficiency.



Abb. 70: Dynamic balancing.



Abb. 71: Dynamic balancing with power characteristic monitoring.

**Pro Tip 1**

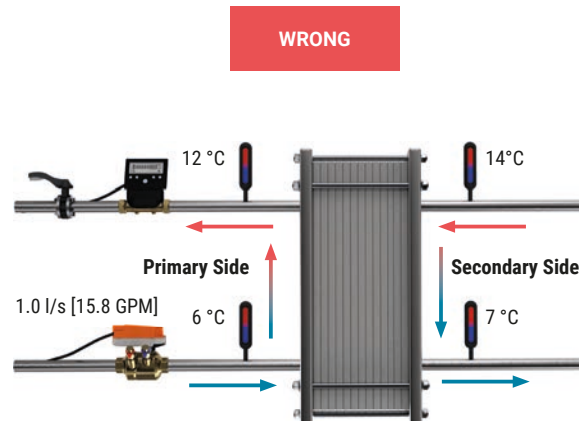
Since heat exchangers tend to get dirty over time, it is good practice to oversize the plate surface by a factor of two. Limiting the maximum transmitted power with power control prevents overloading the heat exchanger. This system delivers the right performance from the start and over a longer period of time and is very tolerant of ageing and prolonged maintenance intervals. In portable water circuits with hard water, scale can build up in the heat exchanger, reducing or blocking the flow rate over a period of 3 to 4 years.

Using the Belimo Cloud, you can remotely reduce power delivered by the Energy Valve should non-payment become an issue. The integration of Energy Valves into a BMS or the Belimo Cloud can also be used for intelligent "load shedding" onto specific consumers or sections, and even enable a temporary reduction of a building's total cooling capacity, e.g. in times of high electricity tariffs.

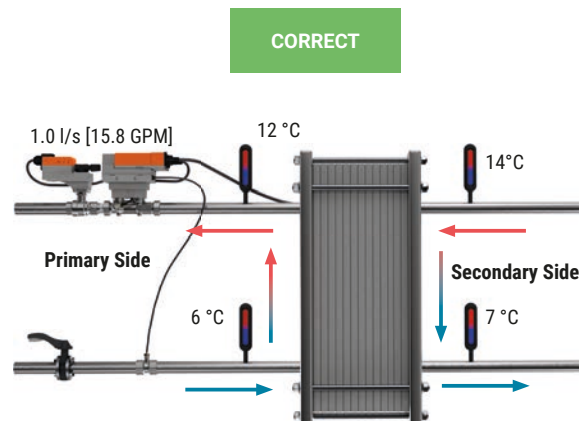
2.4 Success story

The Tennessee State Office Building reduced district energy chilled water usage by 49% by applying the Belimo Energy Valve™.

Founded in 1939, Jones Lang LaSalle (JLL) is one of the world's premier commercial real estate firms. The company is an industry leader in property and integrated facility management services, with a portfolio of 4.6 billion square feet [427.4 million square meters] worldwide.

Since its inception, JLL has been committed to delivering value to its occupants and stakeholders, by putting sustainability at the heart of its services and operations. In Nashville, Tennessee, an example of this commitment produced positive results. The company was able to improve energy efficiency by using the modern functions of the Belimo Energy Valve™ to reduce chilled water usage in multiple buildings.

Facilities and Project Overview

Citizens Plaza stands in the heart of Downtown Nashville. The Class A, 275,000 square feet [25,550 square meters], 15-storey office building was constructed in 1984, and houses multiple Tennessee governmental agencies. During a typical workday, it has anywhere from 800 to 1,200 occupants.

Citizens Plaza receives its chilled water and steam from Metro Nashville District Energy System, which is located nearby on the Cumberland River. Cold water from the plant enters the building at a temperature of 4.4 °C. As part of the contract, return water is to be not less than 12.5 °C, corresponding to a delta T of 8.1 °C. Any water that leaves Citizens Plaza below the contracted delta T results in a thermal inefficiency charge. When JLL took over the management of building operations, the return water temperature was as low as 6.7 K, and this lingering problem needed a solution.

"At Citizens Plaza, we were experiencing high utility thermal inefficiency charges from Metro Nashville District Energy System due to low delta T and over-pumping,' said Chad Lovell, Operations and Safety Specialist at JLL. "We were pushing water too fast through the building and not getting sufficient thermal transfer. Initially, the delta T was between 2.3 to 4.5 K. Before JLL took over the contract, the building was incurring thermal inefficiency charges of \$12,000 to \$13,000 every month. It was obvious that we needed a strategy to increase delta T to reduce our chiller water usage."

The Solution

To solve Citizens Plaza's low delta T syndrome and reduce thermal efficiency charges, JLL turned to Belimo.

"On our first visit to Citizens Plaza, we verified what we already knew: The structure was a Class A office building with air-conditioning units on each floor," said Kevin Leathers, District Sales Manager at Belimo. "As is often the case in older buildings, the air handlers, globe valves, and coils were oversized. We had all the original drawings and realised pretty quickly that the Energy Valve was a perfect candidate for lowering chilled water usage and optimising the flow through the coils and ventilation systems."



Abb. 72: Tennessee State Office Building.

After close communication between JLL and Belimo regional field consultants, Citizens Plaza underwent a pilot project installation with three 2-inch [DN 50] Energy Valves; one each on the 2nd floor, 5th floor, and 14th floor. The scope of work comprised a mechanical valve change-out without any control system modifications. The installer removed the old globe valves and installed the new Energy Valves. With these measures, cold water consumption was reduced by 49% and the penalties for too low delta T values were eliminated.

3

Fan coil

3.1 Application description

A fan coil unit (FCU) heats or cools the air inside a space. A built-in fan draws the air into the FCU and through a heat exchanger for temperature conditioning. The air coming out of the FCU is either cooler or warmer than before. FCUs will generally have a chilled water coil for cooling, and either a hot water coil or an electric element for heating. In commercial applications, fan coil control varies widely, from a thermostat that simply opens and closes a valve to flow-controlled devices that infinitely vary the air volume and modulate the valves.



Abb. 73: Fan coil

3.2 Schematic

The following figure shows a typical application in a room with two fan coil units. The supplied thermal output is controlled by one Energy Valve each. The use of Energy Valves offers the following advantages:

- Dynamic hydronic balancing (in any load condition) of the water flow, achieved by the pressure-independent control valve
- Based on the valve positions of the Energy Valves in a building, the pump speeds can be optimised in such a way that just enough pressure is generated to cover the bad point
- Full system transparency (flow rate, temperatures, cooling/heating capacity, etc.) with data recording on the Energy Valve or optionally in the Belimo Cloud

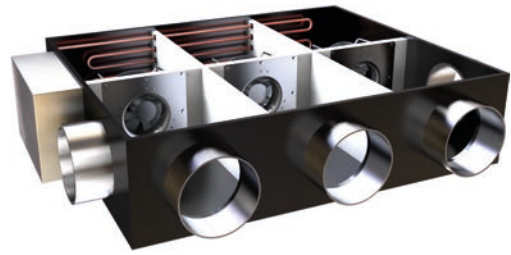

Abb. 74: Typical fan coil application in a single room, with one Belimo Energy Valve™ per fan coil.

3.3 Common problems with fan coils, and how the Belimo Energy Valve™ addresses them

Problem: Low power due to different air flows and water pressures

For optimum heat exchange and occupant comfort while remaining energy-efficient, fan coils require good control of air volumes and water flow rates. However, manufacturers of FCUs often only publish flow requirements for maximum load conditions. Optimum water flow is unknown when the air volumes are set by the user or the controller. Furthermore, when using valves that are not pressure-independent, differential pressure fluctuations in the hydronic system also affect the flow rate through the fan coil unit and thus the heat or cooling energy supplied to or removed from the room.

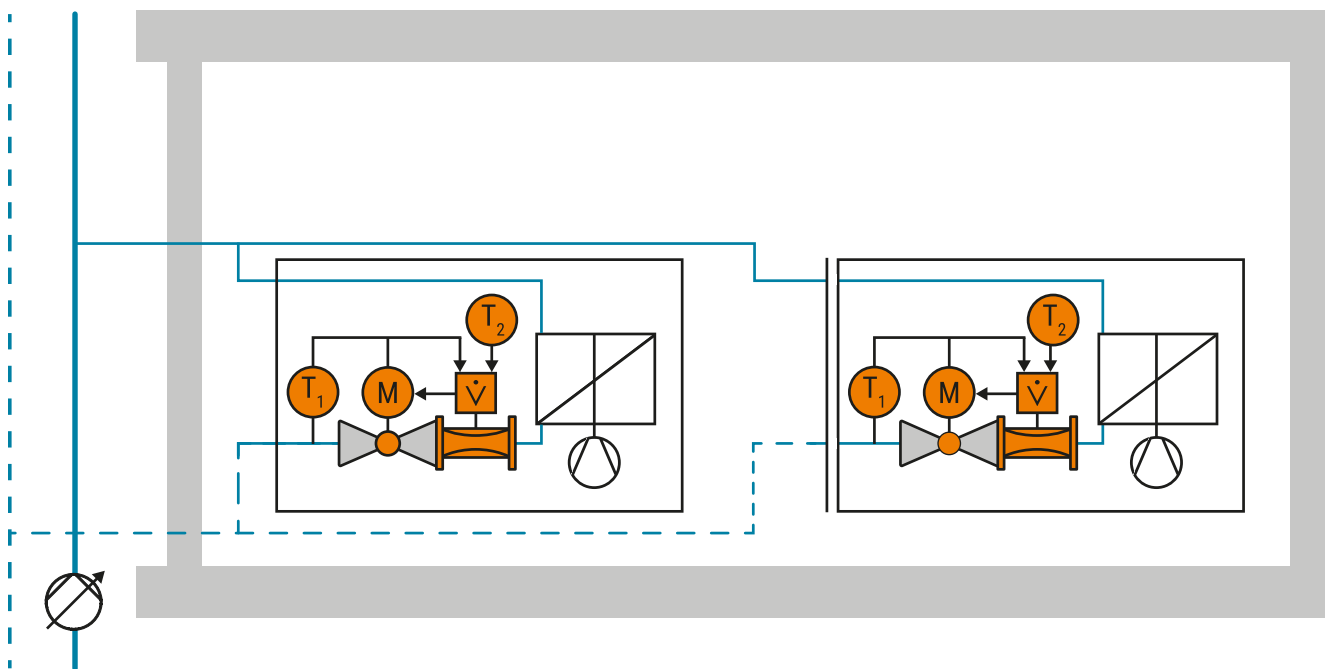
Possible Solution: Dynamic balancing with mechanical PI valves

Reciprocal influence with several consumers is eliminated due to the dynamic balancing. Dynamic balancing is carried out automatically for each operating point.



Abb. 75: Dynamic balancing of a FCU.

Typical design problem:**Poor performance and low delta T syndrome.**

As shown in Figure 76, an FCU is commissioned with the following values: The design water flow is set to 0.11 l/s [1.74 GPM] with air entering the unit at 23 °C.

As the system reacts dynamically after a short time, the pressure in the system increases due to changes elsewhere in the hydronic system. In this particular FCU, the pressure rise caused the FCU flow to be excessively high, thus reducing the delta T and decreasing the efficiency of the heat transfer.

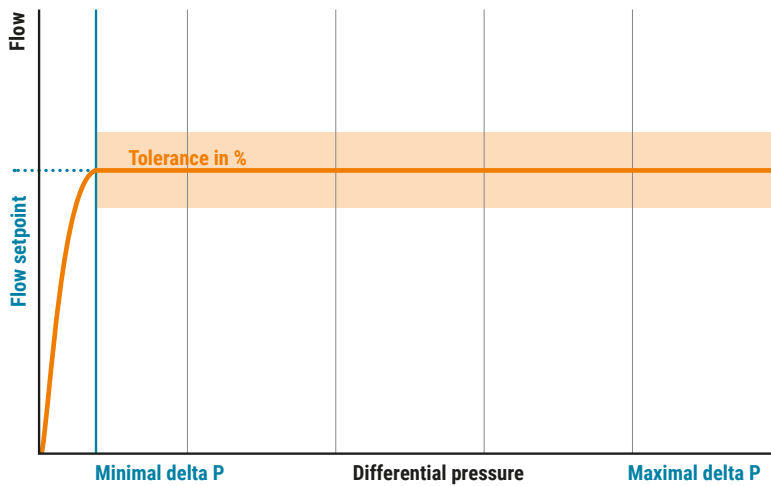
During this time, an occupant in the room may find the airflow annoying and set the fan speed manually to low. When the room temperatures rise, the valve is opened further by the controller until the air is no longer able to extract energy from the heat exchanger. This results in the return water temperature being cooler than expected.

Water flowing too fast causes a low differential temperature (delta T). This not only affects this unit, but also reduces the capacity of the chiller, and the excessive flow is significant at the point of use for the pumps, now 0.14 l/s [2.2 GPM], as shown in Figure 77.

Possible solution:**Mechanical dynamic balancing with PI valve.**

In Figure 78 we see the same FCU working as expected. The flow rate is set to 0.11 l/s [1.74 GPM] with an inlet air temperature of 23 °C. Even if the pressure increases from 2 to 3 bar, the flow rate does not increase.

Flow rate inaccuracy is vastly improved and offers some plant savings, but not as accurate as an electronic valve. The user's adjustment of the fan speed still affects the optimal heat exchange, resulting in low delta T and poor cooling conditions.

Better solution:**Dynamic balancing and delta T manager.**

Figure 79 shows the same FCU working as expected. The flow rate is set to 0.11 l/s [1.74 GPM] with an inlet air temperature of 23 °C.

Again, the system delivers a pressure increase due to changes in other locations. The electronic flow sensor in the Belimo Energy Valve™ detects the increase in flow before the room sensor can register an increase in room temperature. This allows the valve to close slightly to avoid reaching the saturation zone.

When the FCU is kept at low fan speed again, room temperatures rise. The valve is commanded further open by the controller, which would have resulted in the air being unable to remove any more energy from the heat exchanger. The Energy Valve's delta T manager detects the decreasing



Abb. 76: FCU at design operation.



Abb. 77: FCU with valve overflowing.

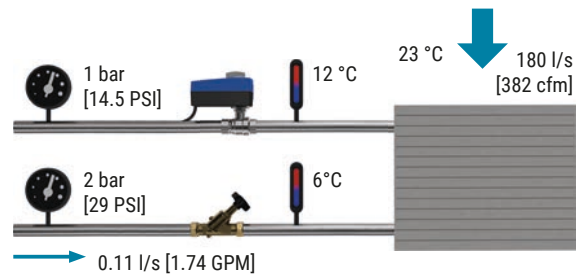

Abb. 78: FCU at design operation.

delta T and overrides the control signal so that the valve cannot be opened any further. This prevents the differential temperature from being too low and avoids the reduction in efficiency associated with it.

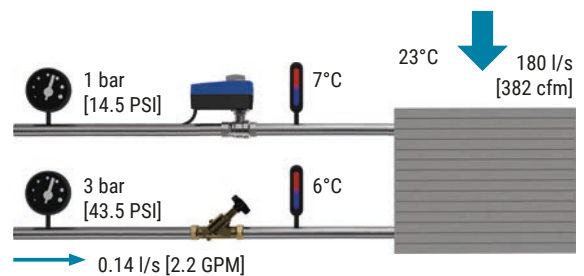
The Energy Valve continuously measures the flow and calculates whether or not compensation is required, based on the control signal input and the delta T manager setpoint. The delta T manager reduced the flow to ensure that the heat exchange is optimal for the air volume set by the user, as shown in Figure 80. This saves pump energy and permanently optimises the system.

Energy Valve solution: Dynamic balancing, power control, and delta T manager.

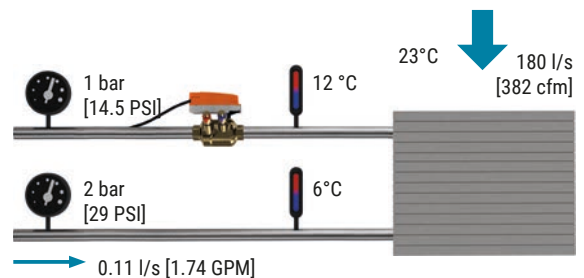
In the age of easily controlled EC/DC fans, variable air volume FCUs represent one of the most energy-efficient methods of air-conditioning a room. However, the control of the fan speed as a function of the valve position is a matter of debate.

When set for power control, the Energy Valve provides a fully linear response, which means that fan speeds can be directly linked to the valve output. This considerably simplifies the control.



Abb. 79: FCU without too much water.



Abb. 80: FCU with delta-T-optimised valve flow.

→ Pro Tip

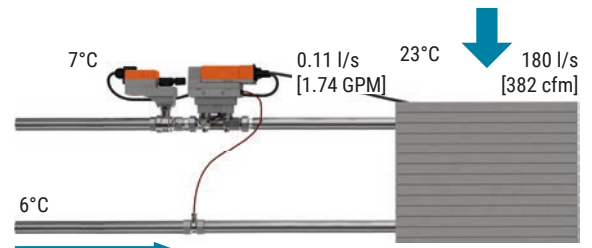
Choose your fan coil setup carefully. It is recommended that the fans pull the air over the coil instead of blowing through the coil in order to maximise the exchange of heat.

Contraflow coils maximise the possible heat exchange by reversing the flow of water against the direction of airflow, to reach highest possible delta T.

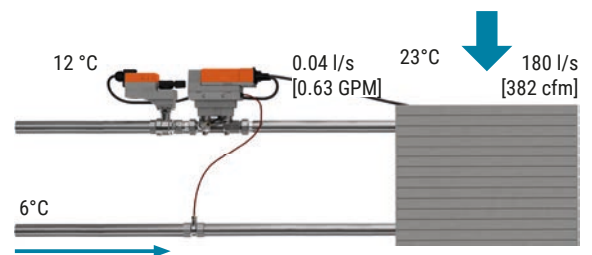
A large grid of small dots, intended for taking notes. The grid consists of approximately 30 columns and 60 rows of dots, covering most of the page area.

NOTES





Abb. 81: Marriott-Hotel Al Jaddaf in Dubai.

3.4 Success story

Five stars for energy efficiency at the Marriott Hotel Al Jaddaf

The Marriott Hotel chain opened a new, extra-class hotel experience in Dubai, UAE on January 15, 2014. With its brilliant design and perfect location in Al Jaddaf, this five-star hotel has an abundance of thoughtfully configured amenities. These include luxurious guest rooms and suites with extensive automatic features to help guests relax. Amenities include luxury bedding, marble bathrooms, high-speed Internet access, and flat-screen TVs, while also providing views of the Dubai skyline. The hotel offers 352 luxury guest rooms and 128 hotel apartments. Belimo's products were able to be implemented efficiently and enable a sustainable and maintenance-friendly operation of the systems.

Initial situation

The Marriott Hotel has been equipped with pressure-independent characterised control valves and modulating actuators for all fan coil units supplying the guestrooms. The EPIVs were installed for the air-conditioning units that supply the kitchen and common areas. The Energy Valves maintain a constant delta T value and were used for the heat exchangers that supply the swimming pool. BMS installer, Johnson Controls, carried out the overall integration of the units into the BMS using the Metasys platform, thereby providing easy control of the Marriott's building services.

Project requirements

- Adhering to the project schedule was crucial.
- The customer wanted to use pressure-independent valve technology to avoid oversizing or undersizing and to ensure maximum control options and efficiency benefits.
- The products used should not require any maintenance or subsequent calibrations.
- Flexibility in adapting to the actual system conditions on site was also important.

Belimo solution

The 1,100 Belimo valves were specified by Arif & Bintoak Consulting Engineers and include Pressure-Independent Characterised Control Valves (PICCV), Electronic Pressure-Independent Control Ball Valves (EPIV) and Energy Valves. All PICCV's were pre-calibrated. These valves are able to control a complex cooling system with 45,461 litres of water throughout the building. The time savings resulting from the solution with EPIVs and Energy Valves offer significant added value over alternative concepts. The time required to commission the system played a decisive role for installers, as delays would have resulted in a contractual penalty according to the terms of the contract. By using the Belimo Energy Valve™, the system is not only energy-efficient thanks to the recording of all data, but also provides the building services with further optimisation potential. With the Belimo electronic pressure-independent valve (ePIV), it is easy to adjust the maximum flow rate, and thanks to 'air bubble tight', closing characterised control valve, no leakages are possible. The valves thus allow the system to be controlled with easy-to-install, versatile, transparent, and safe products.



Abb. 82: The supply of the fan coils is equipped with the Belimo Energy Valve™.

Customer Benefits

- The Belimo Energy Valve™ ensures control of the flow and thus the power of the heat exchanger and monitors the delta T value.
- Easy selection without k_{vs} calculation
- Significantly reduced operating costs from the beginning of the project and throughout the entire life of the system.
- Easy integration of the measuring, control, and regulation technology.
- Engineers avoid complex individual measurements at the design stage, and gain greater peace of mind that the system will operate correctly from the beginning.
- The Facility Manager is able to control the hotel efficiently from the BMS dashboard.
- The equal-percentage flow characteristic leads to better system controllability. The constant flow rate considerably reduces the rotary movement of the actuators, which causes much less wear on the valve assembly.

4

Chilled beams

4.1 Application description

A heating and/or chilled beam is a convection HVAC system designed for heating and/or cooling rooms, as are typically used in open-plan office buildings. The pipes are led through a "beam" (a heat exchanger), which is either directly integrated into a suspended ceiling or hangs below the suspended ceiling of a room. There are two types of chilled beams in use today: A passive beam cools the air around it and creates a natural convection current whereby the cooled air falls down and warmer air rises up to replace it, thus cooling the room. Active chilled beams are widely used as well, and use air from an AHU to induce additional airflow over the beam.

The principal challenge with this application is the control of the water temperature and flow rate, assuring that the surface temperature of the beam does not fall below the dew point of the space.



Abb. 83: Ceiling-integrated chilled beam with air and chilled water supply.

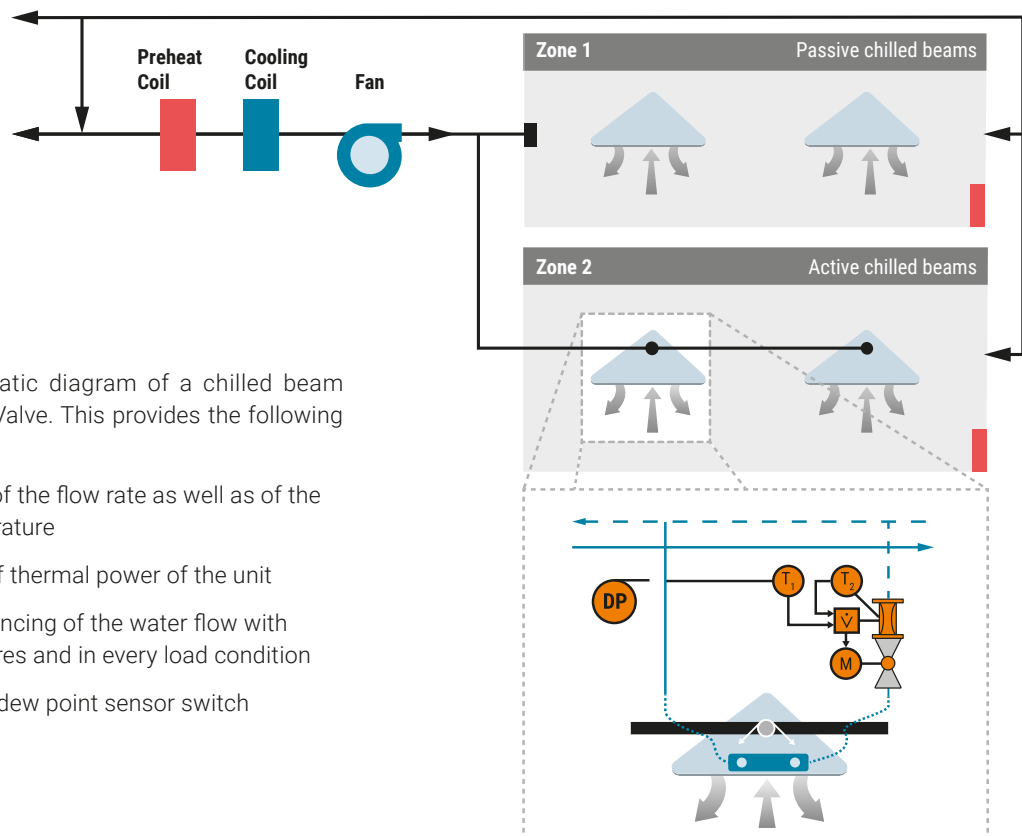

4.2 Schematic

Figure 84 shows a schematic diagram of a chilled beam application with an Energy Valve. This provides the following control functionality:

- Accurate measurement of the flow rate as well as of the supply and return temperature
- Monitoring and control of thermal power of the unit
- Permanent hydronic balancing of the water flow with changing system pressures and in every load condition
- Optional integration of a dew point sensor switch

Abb. 84: Chilled beams in a multi-zone system.

4.3 Common problems in chilled beam applications and how the Belimo Energy Valve™ solves them

Problem: Pressure fluctuations affecting flow rates and comfort

Large chilled water systems are inherently dynamic and exhibit pressure fluctuations caused by changes in pump speed and valve position. Statically balanced systems, as the name implies, are not able to handle these dynamic changes and as a result, the flow rate through each unit fluctuates with the pressure changes.

Possible solution: Dynamic balancing

The dynamic balancing function of a pressure-independent valve handles pressure fluctuations in the system, and assures that the flow is maintained on the defined setpoint.

Problem: Condensate forming on the chilled beam

Low water temperatures and insufficient humidity control can lead to condensation on the chilled beam and subsequently cause costly damage to furniture and office equipment. However, conservative supply water temperatures can result in insufficient cooling capacity.

Solution: Early detection of low supply temperatures with the Belimo Energy Valve™

With the more accurate and responsive flow sensor of the Belimo Energy Valve™, systems are able to detect and shut off water flows before condensate forms on the chilled beams.

Reliable data from both the space and the water temperatures is the key to maximising chilled beam performance, while minimising the risk of condensate forming.

A humidity or temperature sensor can be used to measure the air conditions and adjust the control accordingly.



Abb. 86: Condensation of humid air on the cold coil surface. The supplied cold water must be above the dew point in the room to prevent condensation.

The supply air into the room and the circulating air out of the room flow through the heat exchangers of the chilled beam. The indoor dew point must be kept below the surface temperature of the chilled beam coil to prevent condensation from forming.

The primary air system in the AHU serves to balance the latent thermal load and usually keeps the indoor dew point at or below 13 °C to prevent condensation.

Furthermore, the temperature of the water supplied to the beam is usually kept between 14 °C and 16 °C, sufficiently above the dew point of the room.



Abb. 85: Dynamic balancing of a chilled beam.

To prevent condensation on the chilled beam in the room, the humidity of the air supplied to the units, and/or the temperature of the cooling water must be adjusted to the dew point in the room.

The cold water supply line must be insulated diffusion-tight. A condensate sensor is installed on a short, uninsulated pipe section in front of the unit. The supply water temperature is controlled using this sensor.

If condensation is detected, two control strategies are possible:

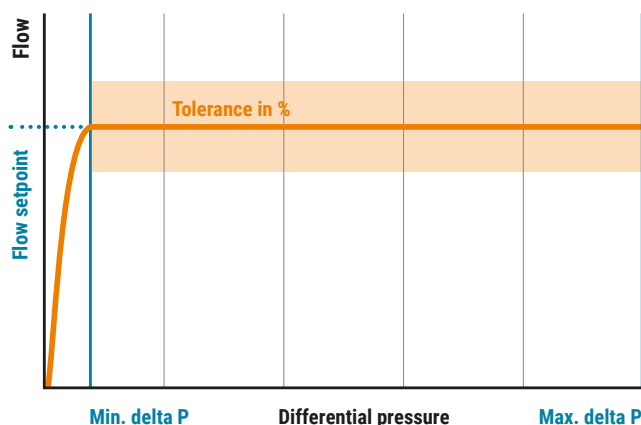
1. The supply temperature is increased, resulting in a variable supply temperature to prevent condensation. A negative side effect is that the possible cooling effect of all subsequent chilled beams is reduced, but the water flow is still permissible at the design level.
2. The branch water supply flow is reduced with the control valve of each subsequent chilled beam. Depending on the floor and piping layout, a central dew point sensor per unit may be required.



Abb. 87: Belimo 22HH-100X, condensation switch.

→ Pro Tip

The recommended indoor air temperatures and air humidity values (maximum values) as well as the recommended cold water temperatures can be found in the local standards.

For smaller cooling loads in the room or large cooling surfaces, the cold water temperatures can be increased by a few degrees (e.g. up to 18 °C).

It should still be possible to maintain sufficient cooling in the room. By doing so, dehumidification can be carried out in an energy-saving manner.



Abb. 88: The dew point depends on the air temperature and the air humidity.

4.4 Application example

Typical design:

Poor performance due to high flow

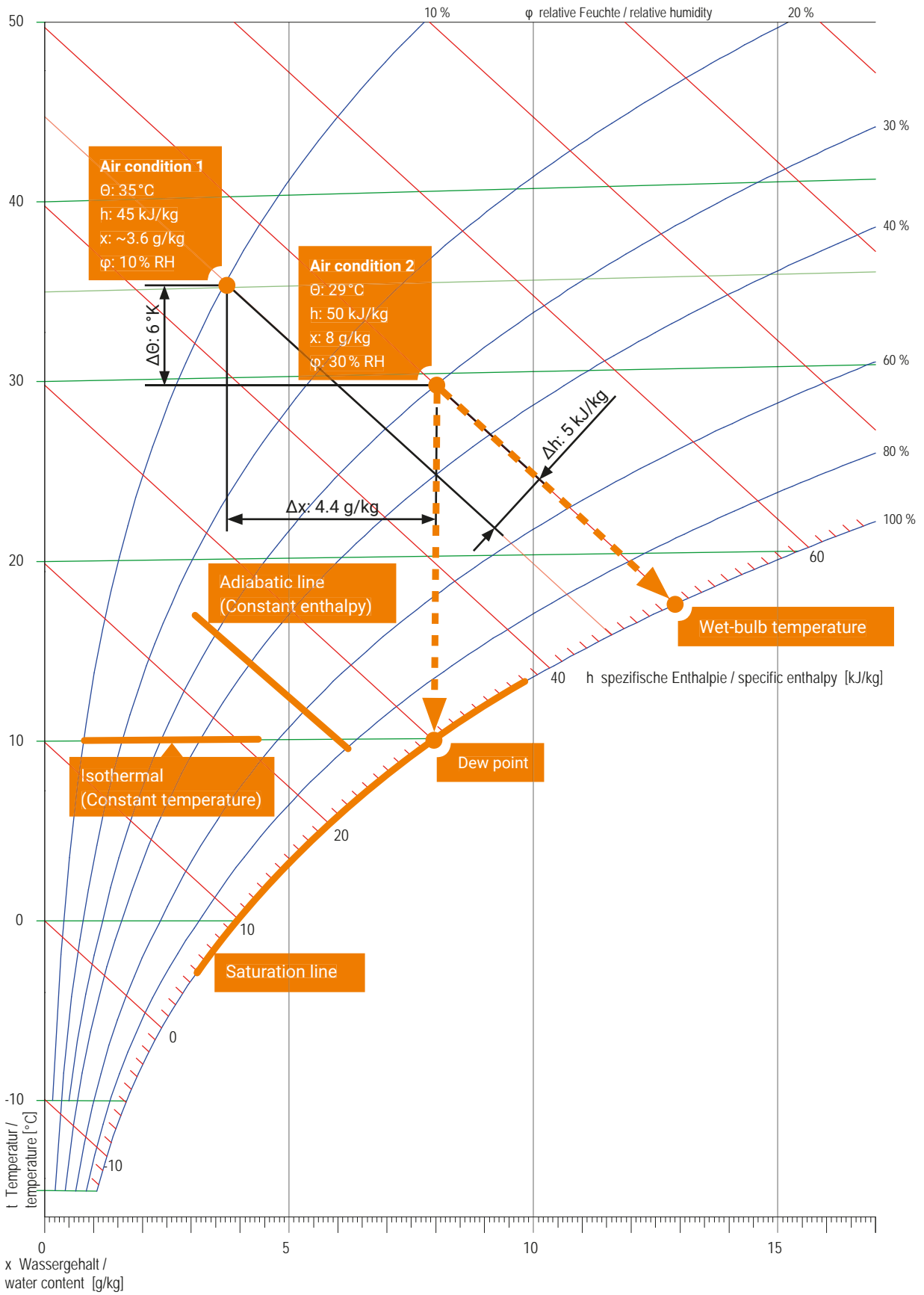
In Figure 89, a Chilled Beam is not working as expected. The water flow should be 0.12 l/s [1.9 GPM], with a delta T of 3 °C and a differential pressure across the circuit of 1 bar [14.5 PSI]. However, due to the pressure changes in the system, delta P increases from 1 to 2 bar [14.5 to 29 PSI], and different loads are needed. The chilled beam receives 25% more water than planned. This results in poor comfort in the ambient and lowers the efficiency of the heat transfer.

PI Valve:

Dynamic balancing to avoid overflow

As shown in Figure 90, the use of the mechanically pressure-independent valve PIQCV guarantees the design flow of 0.12 l/s [1.9 GPM], even if pressure fluctuations occur in the system. This results in better control and comfort.

Energy Valve: Dynamic balancing, delta T manager, and data transparency.

The Energy Valve maintains the flow at 0.12 l/s [1.9 GPM] regardless of pressure fluctuations, as shown in Figure 91. It also monitors the delta T across the coil and provides all important data on flow, temperatures and energy to the BMS.

With the help of the data provided by the Energy Valve, many other functions are available, such as early detection of likely condensate problems.

As shown in Figure 91, the Energy Valve is on the same network as the sensor and the BMS logic. The BMS monitors the water supply temperature and calculates the dew point based on the relative humidity and temperature data provided by the room unit.

The BMS detected that the temperature of the entering water has reached the dew point and closes the valve to prevent condensate from forming on the device.



Abb. 89: Chilled beam with a pressure-dependent valve.



Abb. 90: Chilled beam with a mechanical PI valve.

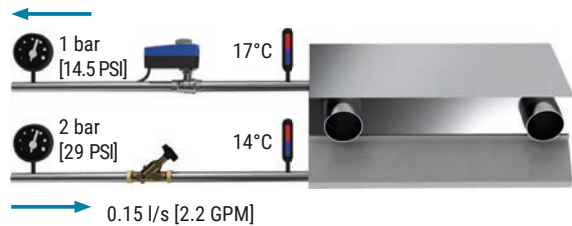

Abb. 91: Chilled beam with an Energy Valve.

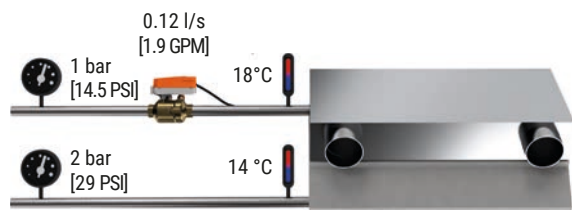

Abb. 92: Chilled beam with an Energy Valve, for which the BMS calculates the dew point using data from a room sensor.

5

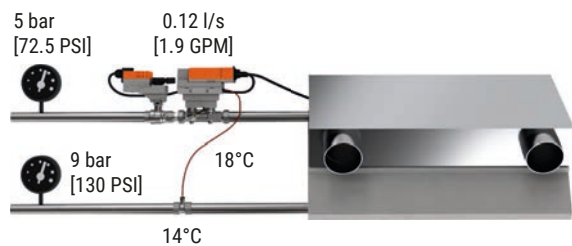
Heating/cooling changeover

5.1 Application description

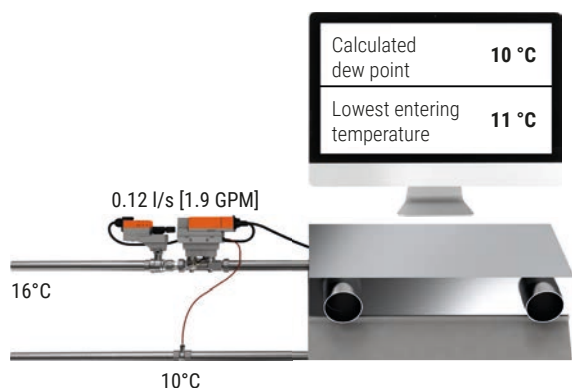
Heating/cooling changeover systems are usually used where it is too expensive to lay double-routed pipe systems to each consumer or where it is expected that heating or cooling will be required throughout the building at any one time. With a single set of pipes, the terminal can either heat or cool.

Ordinarily, it is expected for the space to have some form of backup heating (typically electric elements), to use when the system is in cooling and only when a few zones require heating.

Changeover systems are suitable for:

- Fan coil units
- Chilled beams
- Cooling ceilings
- Floor heating (mostly in residential buildings)

5.2 Schematic

Figure 93 shows a simplified representation with a single terminal unit. However, using Energy Valves instead of standard control valves allows consulting engineers to use the more cost-effective 2-pipe design and still achieve the same level of comfort as with 4-pipe systems. Energy Valves can be updated with different flow and delta T setpoints for cooling and heating, i.e. the BMS can control the same valve, depending on the requirement.

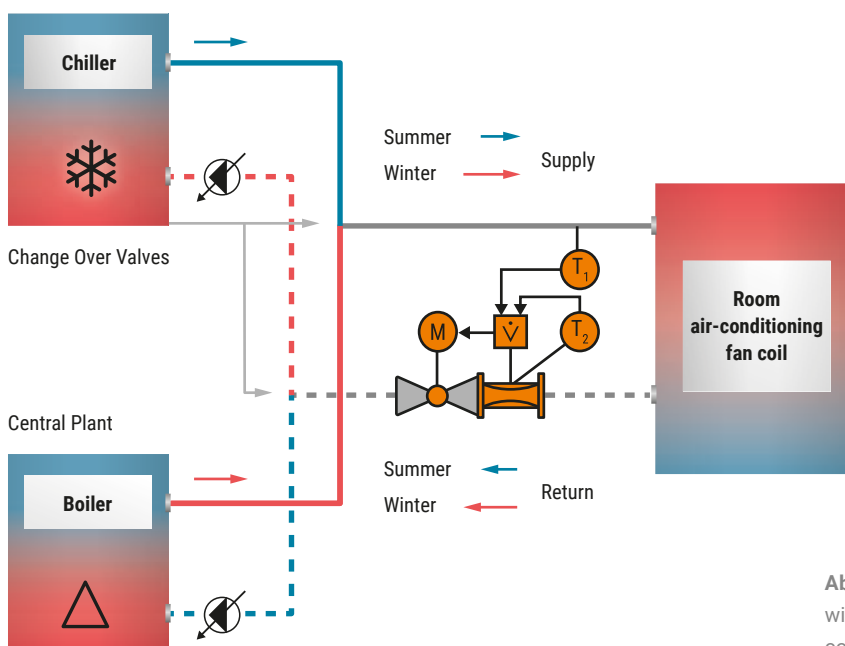

→ Pro Tip

Choosing the right valves for the change between heating and cooling is important. Globe valves typically have a certain amount of leakage water passing through the valve, even when closed. This causes hot water to leach into cold water or vice versa. In both cases, energy is lost.

Problem: Pressure fluctuations affecting flow rates and comfort

Large chilled water systems are inherently dynamic and exhibit pressure fluctuations caused by changes in pump speed and valve position. Statically balanced systems, as the name implies, are not able to handle these dynamic changes and as a result, the flow rate through each unit fluctuates with the pressure changes.

Possible solution: Dynamic balancing

The dynamic balancing function of a pressure-independent valve compensates for pressure fluctuations in the system and ensures that the flow is maintained at the specified setpoint.

Abb. 93: 2-pipe changeover system with an Energy Valve for optimum comfort in summer and winter.

5.3 Common problems in changeover systems and how the Belimo Energy Valve™ solves them

Problem: Insufficient power in heating mode

Heat exchangers or coils are typically selected in accordance with cooling loads, meaning that if the water medium is switched from cold to warm, the design flow rates are no longer suitable. For example, a typical delta T for cooling applications would be 7 K, whereas a delta T of at least twice that would be expected for heating.

Solution: Adjustable flow rates for heating/cooling season

Because an intelligent valve is able to communicate at a high level with the BMS, the maximum flow setting values can be adjusted remotely. This allows the design flow to be changed so that the valve always controls the optimal flow.

Problem: Low delta T syndrome

As the heat exchanger is not only experiencing a change in water temperature, it could be experiencing a change in air volume in line with the new mode. With multiple variables of the heat exchange fluctuating, it now becomes virtually impossible to completely predict the correct flow rate over the range of permitted flows.

Solution: Energy Valve using the Delta T Manager

The delta T manager, integrated in the Belimo Energy Valve™, is a function that continuously measures the temperature spread and compares it with the system-specific limit value. If it falls below this, the Belimo Energy Valve™ automatically adjusts the flow so that only the amount of water actually needed is allowed through the heat exchanger. You can easily update the desired delta T via the bus interface, thus giving you complete control.



Abb. 94: Low delta T at a consumer (e.g. fan coil).



Abb. 95: The Energy Valve's delta T manager guarantees that a minimum delta T is not fallen short of.

5.4 Application example

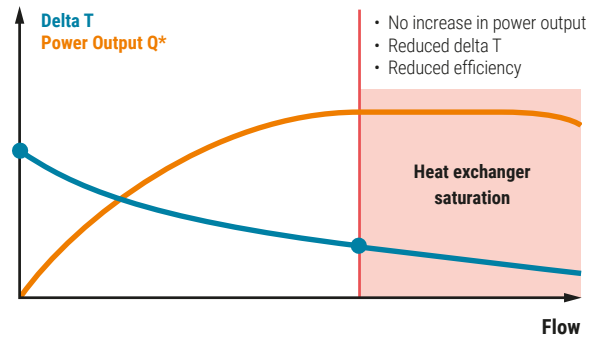
Typical design:

Low efficiency and low delta T syndrome.

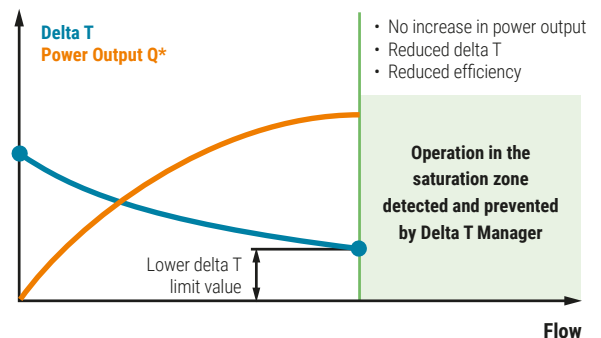
The example shown in Figure 96 shows a conventional setup with a flow rate of 0.35 l/s [5.55 GPM], based on the required cooling capacity, at a supply temperature of 6 °C and a return temperature of 12 °C. The heating flow rate required for the space is 0.17 l/s [2.69 GPM]. However, the system is set to a flow rate of 0.35 l/s [5.55 GPM]. As a result, the heating falls into cycle mode.

This works to a certain extent, but the low delta T during the heating phase usually reduces the efficiency of a condensing boiler because the return temperatures are too high to condense the exhaust gases. Since the heat exchanger receives the same flow of 0.35 l/s [5.55 GPM] during heating operations, the water is not able to release enough energy to the air, resulting in high return water temperatures or low delta T, as shown in Figure 97.

As this solution is not equipped with PI valves, we still suffer from pressure fluctuations that typically occur with non-PI valve setups. As a result, the delta T will remain too small.

Solution: Dynamic balancing, setting value change, and delta T management.

As shown in Figures 99 and 100, the correct setting values for the maximum flow rate and the delta T to be maintained for heating and cooling operation can be undertaken easily via the BMS.

When the Energy Valve is updated with heating flow rates and delta T, the valve switches to 0.17 l/s [2.69 GPM] and enforces a minimum delta T of 30 K. Condensing boilers can now be used, as the return water temperatures can be guaranteed.



Abb. 96: FCU in cooling mode.



Abb. 97: FCU in heating mode.

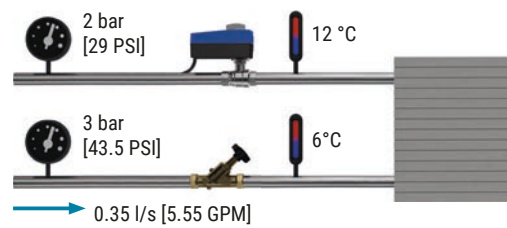

Abb. 98: FCU heating mode and differential pressure increase.

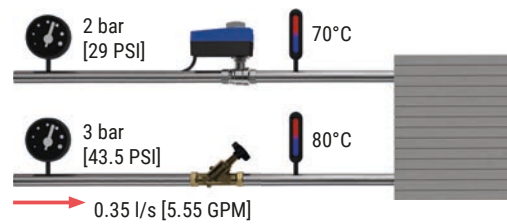

Abb. 99: FCU in cooling mode, using a pressure-independent EV.

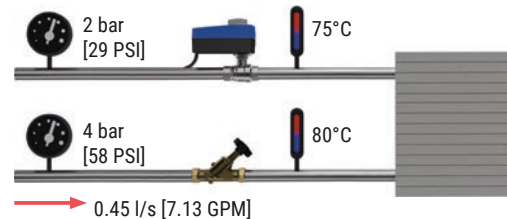

Abb. 100: FCU, with BMS-corrected heating setpoint and required flow rate.

→ Pro Tip

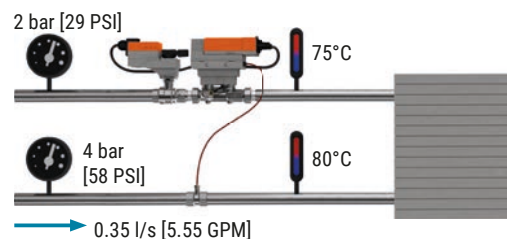
The Energy Valve also records the consumption of heating and cooling energy separately. Instead of two devices, one for cooling energy and one for heating energy, only one device is now necessary.

6

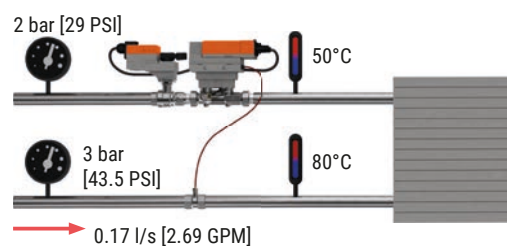
Distribution and delta T management

6.1 Application description

Large distribution systems, either as a building or as part of a larger building complex, require an optimal delta T to operate efficiently.

Sometimes it is not possible to install an Energy Valve at every consumer.

6.2 Schematic

The Belimo Energy Valve system shown in Figure 101 offers the following advantageous functions:

- The supplied area can be monitored, as important information such as the amount of water drawn off, the flow and return temperature, as well as the energy consumption can be seen.
- It can be ensured that no one area of the system draws too much water and thus energy.
- The flow through the individual consumers can now be checked using flow measurement carried out by the Energy Valve by opening the valves one after the other. By closing all valves, determination is made whether water is let through at the consumers due to valve leakage when they are closed, or whether a bypass valve is open.
- Full branch transparency (flow, temperatures, cooling/heating capacity, etc.) with data recording and connection to the Belimo Cloud.



Abb. 101: A schematic diagram of the installation of an Energy Valve in a branch.

6.3 Common problems in distribution systems

Problem in existing buildings

In existing systems with numerous consumers, there can be problems during operation that negatively affect occupant comfort and energy efficiency. For example, although sufficient energy is provided, certain areas may not be supplied with sufficient heating or cooling energy during peak times. Furthermore, the effective delta T at the connection point to district heating or cooling can be lower than planned, which in turn can lead to penalties for the energy supplier.

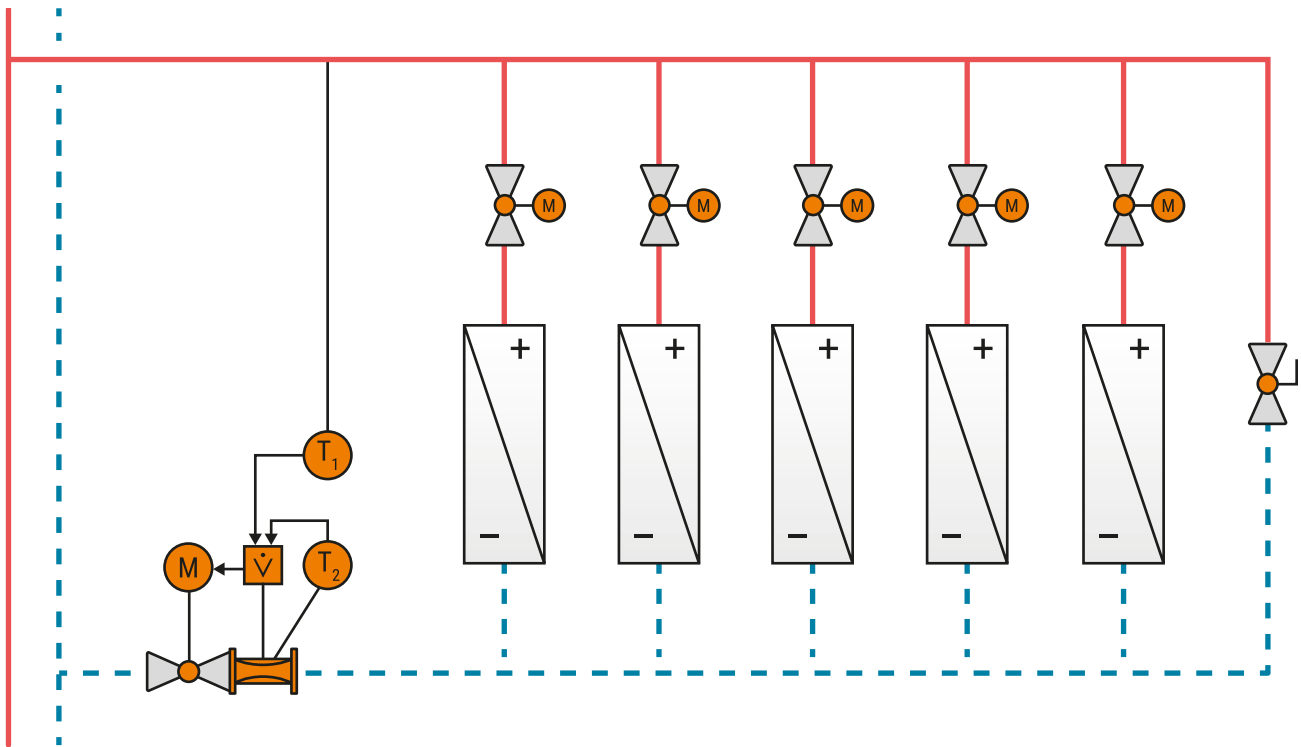
Figure 102 shows a pressure dependent system with a single balancing valve. This is a typical contract installation of several low-temperature systems, such as with underfloor heating.

Solution: Retrofit with Belimo valves.

This can be remedied by retrofitting Energy Valves to every branch. By monitoring flow and delta T delivered to a number of terminal units, system operators can identify problematic consumers in the system and unclosed bypasses.

Thanks to the resulting transparency, problem areas can be identified and remedied more quickly. This in turn increases comfort and ensures energy-efficient operation.

The replacement of defective control valves on the consumers previously identified thanks to the Energy Valve with air-bubble tight closing zone valves from Belimo (e.g. QCV) provides further energy savings.

Problem: Unknown flow rates with mechanical valves.

Our need to operate buildings more efficiently means that water flow rates should be checked not just once but several times a season. Experience shows that tenant "improvements" or changes to the hydronic system have a negative effect on pressure-dependent installations.

However, even if PI valves are installed, checking the globe valves and open bypasses should still be a priority to keep the delta T within an acceptable range.

Solution: Multiple flow dynamic measurements.

By using an Energy Valve in the branch line, we can measure the total flow to the consumers and also to each individual unit when they are opened one after the other. This is shown in Figure 103.



Abb. 102: Mechanical balancing valves allow only static balancing of the total flow, whereby the flow rates to each individual unit are unknown.



Abb. 103: With a Belimo Energy Valve™, the flow in the branch can be measured when each valve is opened, allowing verification.

Problem: "Ghost energy" in the building.

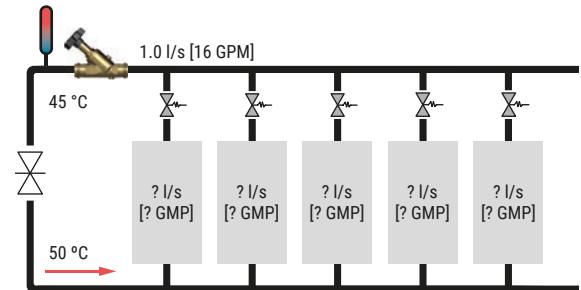
We speak of "ghost energy" when water reaches the consumer through leaking valves when there is no heating or cooling capacity. This unnecessarily transports energy from the producer to the consumer and delivers it to the consumer. Figure 104 shows an example where the bypass has not been closed after maintenance and some valves are leaking in the closed position.

Solution: Multiple flow dynamic measurements.

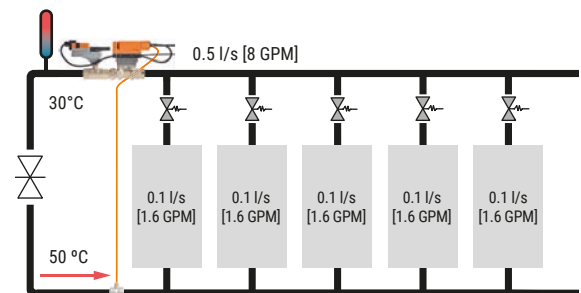
By using a Belimo Energy Valve™ in the branch line, we can measure the total flow of each individual unit. You can ensure bypasses are closed and valves are not leaking. If multiple end valves are leaking, the Energy Valve can be closed to prevent flow when the branch is not in operation.

Problem: Low delta T syndrome.

Often, terminal units are statically balanced, which leads them to overflow and deliver low delta T when in part load. Valves may be allowing water past them when they should be closed. Sometimes, even a bypass left open can stay undetected, reducing the pressure and dragging the delta T down.

Solution

The Delta T Manager, integrated in the Belimo Energy Valve™, is a function that continuously measures the temperature spread. This information can be used to trigger an alarm while you are troubleshooting the branch looking for leaking valves or bypasses left open. Once the branch is working as well as possible, you can activate the delta T manager to limit the overflow in the branch.



Abb. 104: An accidentally opened bypass valve may be discovered only after weeks, months or even years.



Abb. 105: With an Energy Valve, not only leaking short-stroke globe valves but also an open bypass can be clearly identified.

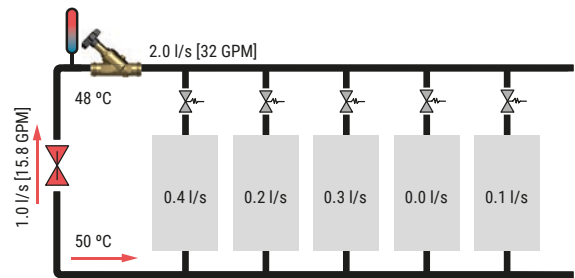

Abb. 106: Low delta T syndrome

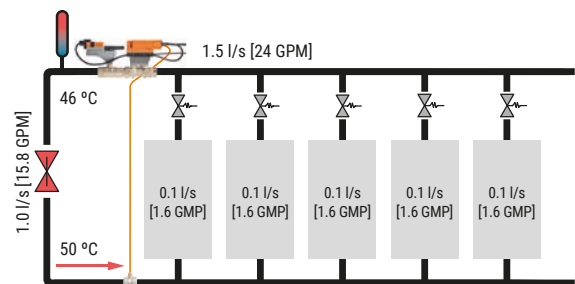

Abb. 107: Delta T manager

6.4 Success story

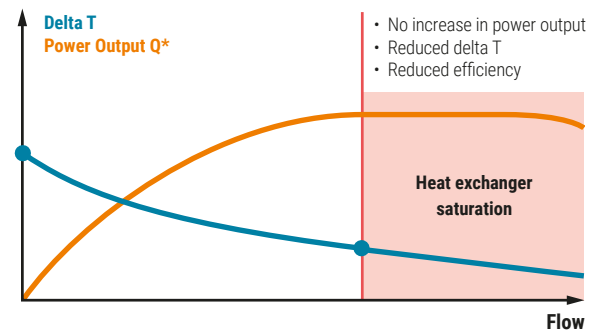
Belimo Energy Valve™ successfully used at Ludmillenstift Hospital in Meppen

The Ludmillenstift Hospital in Meppen, Germany, is renowned well beyond the local area for its standard of medical care, state-of-the-art diagnostic and therapeutic technology, and its pleasant atmosphere. However, a large number of modernisations over the years, in the form of extensions or modifications, resulted in problems in the hospital's hydronic distributor circuits. These have finally been rectified through the use of Belimo Energy Valves™.

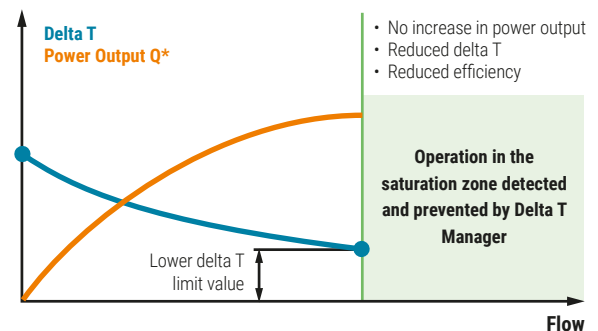
Time and again, the heating system's hydraulics used to be a major headache for the building services technicians. Several rooms and zones in the hospital, which covers approximately 50 000 m², didn't receive adequate hot water, resulting in complaints about cold rooms. It was up to Günter Wilmink and Kristian Fitzner, the Installation and Heating Supervisors, to find a solution. After the Energy Valves with monitoring capability were retrofitted in spring 2013, the building services team was finally able to visualise the problems and then rectify them step-by-step.

The challenge

Since there were hydronic problems in the heating circuits, various departments and specialist areas on the large hospital site could not be guaranteed a supply of regular heat. Initial attempts to control the hydronics using manually adjustable, differential pressure controllers were fruitless. Pumps were also fitted, components were equipped with hydronic deflectors, the supply temperature for hot water was raised to 90 °C, and all pumps were set to maximum capacity. However, this resulted in more water flowing through the pipes, which exacerbated the hydronic problems. In the areas most badly affected, the differential temperature between the hot water's supply and return was just 5 Kelvins.

Huge increase in operating costs, as manual adjustment could not solve the dynamic problem

These changes greatly increased the costs of pumping and gas consumption – including steam generation of around one million cubic metres a year – putting strain on the hospital's budget. Peter Meier, Specialist in Control Technology at the heating firm August Brötje KG (Bremen, Stuhr), has been assisting the hospital for around 10 years, and recommended that the service technicians in Ludmillenstift take a look at the new Belimo Energy Valve™. Following a presentation by Belimo employee, Rainer Frase, which detailed what the intelligent control valve could offer and how it works, they planned installation in the highly problematic distributor circuit 1. This supplies the individual buildings housing in-patients, a residential block for staff, and a hotel for family members. A total of eight Energy Valves



Abb. 108: Ludmillenstift Hospital.

were installed in several zones in the spring of 2013, and were linked to the existing Siemens building management system via the BACnet/IP interface.

The two building services technicians are constantly delighted by a special feature in the Energy Valves. With its integrated measuring sensors for the flow rate and water temperatures, the integrated web server enables an exact display of the current operating data, which can be called up on a laptop or through building automation on a PC. This makes it clear which temperatures, flow rates, and heat flows are currently present in each hydronic circuit. A database that stores this operating data also makes it possible to allocate the heat quantities consumed to rooms, zones or departments (cost centres) of the hospital.

A large grid of small dots, intended for taking notes. The grid covers most of the page area.

NOTES



7

Computer room air-conditioning unit

7.1 Application description

A Computer Room Air Conditioning (CRAC) unit is designed for applications where close control, high precision air conditioning is essential. This includes cooling data centres, server environments, telecommunications switchgear, medical operating theatres, and clean room environments.

Often, air-conditioning units in computer rooms are considered so critical that they require their own chilled water system. The constant availability of maximum power means that a CRAC device always requires water at a predefined minimum temperature to ensure that peak power is always available.



Abb. 109: Typical CRAC devices.

7.2 Schematic



Abb. 110: Schematic of a CRAC device, including airflow to/from the racks.

7.3 Common issues in CRAC units, and how the Belimo Energy Valve™ can address them

Since CRAC devices must be able to handle maximum load at all times, water with a predefined minimum temperature is required. Given the critical nature of their task, CRAC devices tend to be oversized. The resulting overflow cannot be converted to energy by the CRAC unit, and is reflected in elevated water temperatures or low delta T.

A Belimo Energy Valve™ using power control and delta T management, can ensure that peak performance is available even with varying water temperatures.

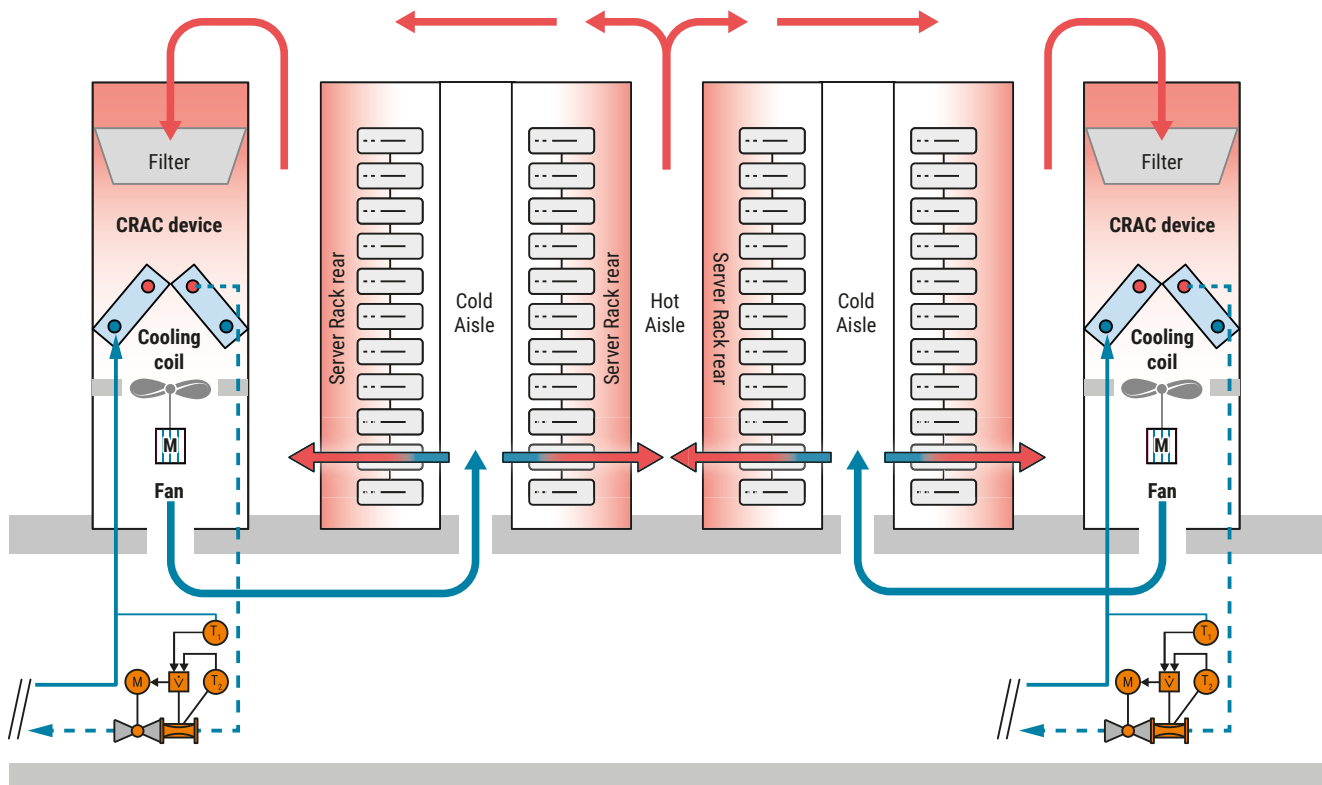
Parametrise your Energy Valve to use power control and set the required design power. The valve then modulates the power output, depending on the input of the control signal, by varying the delta T-dependent flow to achieve the desired output.

Using the formula $Q = M \times CP \times \Delta T$ (power = flow rate x specific heat capacity x differential temperature), you can see that flow rate and delta T are linked when it comes to the power of a heat exchanger. We cannot change one variable without affecting the other.

Power control uses this formula to adjust the flow according to power requirements derived from the control signal.

7.4 Application example

The CRAC device shown in Figure 111 must supply 29.4 kW [100,000 BTU]. It has a design flow of 1 l/s [16 GPM] and a supply temperature of 7 °C, with an expected return temperature of 14 °C. This is considered "design load" conditions.

Under low system load scenarios, the water temperature supply by the chiller may be increased for promoting energy savings. If the same device now has a supply temperature of 10 °C, the higher supply temperature could result in a lower delta T, which would reduce the available power. The Belimo Energy Valve™, having measured a lower delta T, will allow an increase in flow rate to 1.4 l/s [22 GPM] to achieve the required output. In this case, the change in supply water temperature has no negative impact on the air-conditioning unit's ability to deliver the required cooling load.



Pro Tip

Correctly set rack cooling temperatures and regularly replaced air filters can massively reduce energy consumption and increase the service life of IT components.

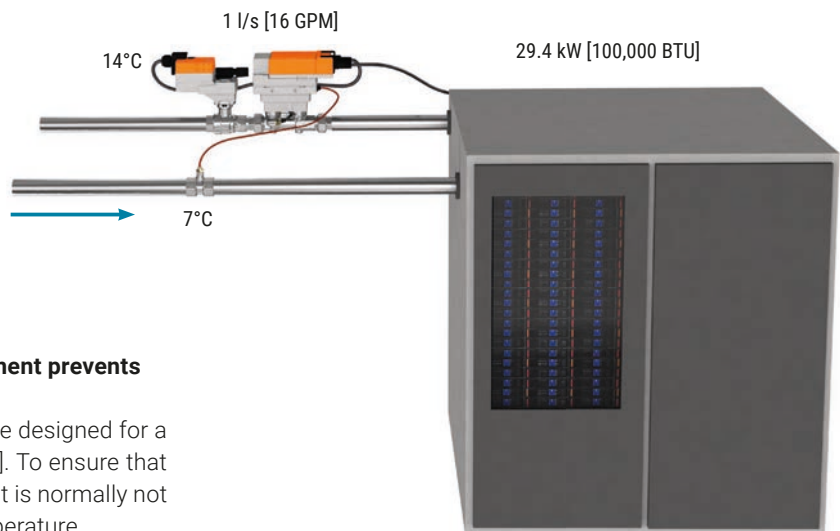

Problem: 100% output requirement prevents variable water flow rates

Figure 111 shows a CRAC device designed for a power of 29.4 kW [100,000 BTU]. To ensure that peak power is always available, it is normally not possible to vary the supply temperature.

Abb. 111: CRAC device under "design load conditions".

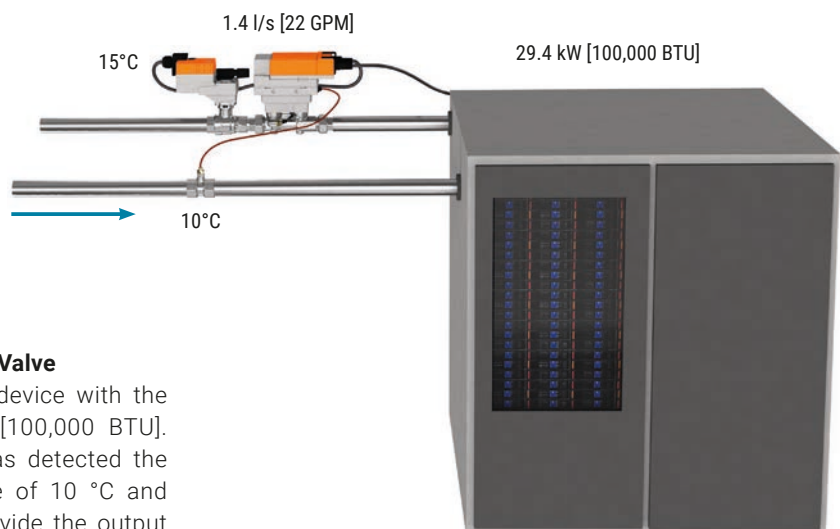

Solution:

Power control-enabled Energy Valve

Figure 112 shows the same device with the same demand for 29.4 kW [100,000 BTU]. However, the Energy Valve has detected the increased supply temperature of 10 °C and increased the flow rate to provide the output required by the control signal.

Abb. 112: CRAC device with higher supply temperature to save energy.

8

Central heating system

8.1 Application description

The central heating plant combines one or more heat sources into a complete system. Fossil combustion solutions, such as oil or gas boilers, are gradually being replaced or supplemented by alternative solutions. Heat pumps or renewable forms of heat generation, such as thermal solar systems, are on the rise and help to reduce CO₂ emissions.

Energy efficiency in a boiler room depends on the careful selection of the heat generator and the use of suitable pipelines for hydronic distribution, as well as consumer circuits with high-quality valves that control precisely and close air-bubble tight when not in use.



Abb. 113: Condensing gas boiler



Abb. 114: Heat pump with potable hot water storage tank.

8.2 Schematic

Modern heating systems are often more complex and require more transparent monitoring to ensure that the targeted savings are also actually achieved in practice. The Belimo Energy Valve™ is an excellent tool for creating transparency and ensuring correct long-term operation of the heating system.



Abb. 115: Typical hydronic diagram of a central heating system combining several alternative and renewable energy sources.

8.3 Common problems with boilers and how the Belimo Energy Valve™ solves them

Retrofitting an existing system with an Energy Valve not only ensures that the valve eliminates hidden water circulation during standby times, but also creates full system transparency (flow, cooling/heating capacity, temperatures, and set thermal energy) with data recording and optional connection to the Belimo Cloud.

Problem: Low efficiency with older boilers

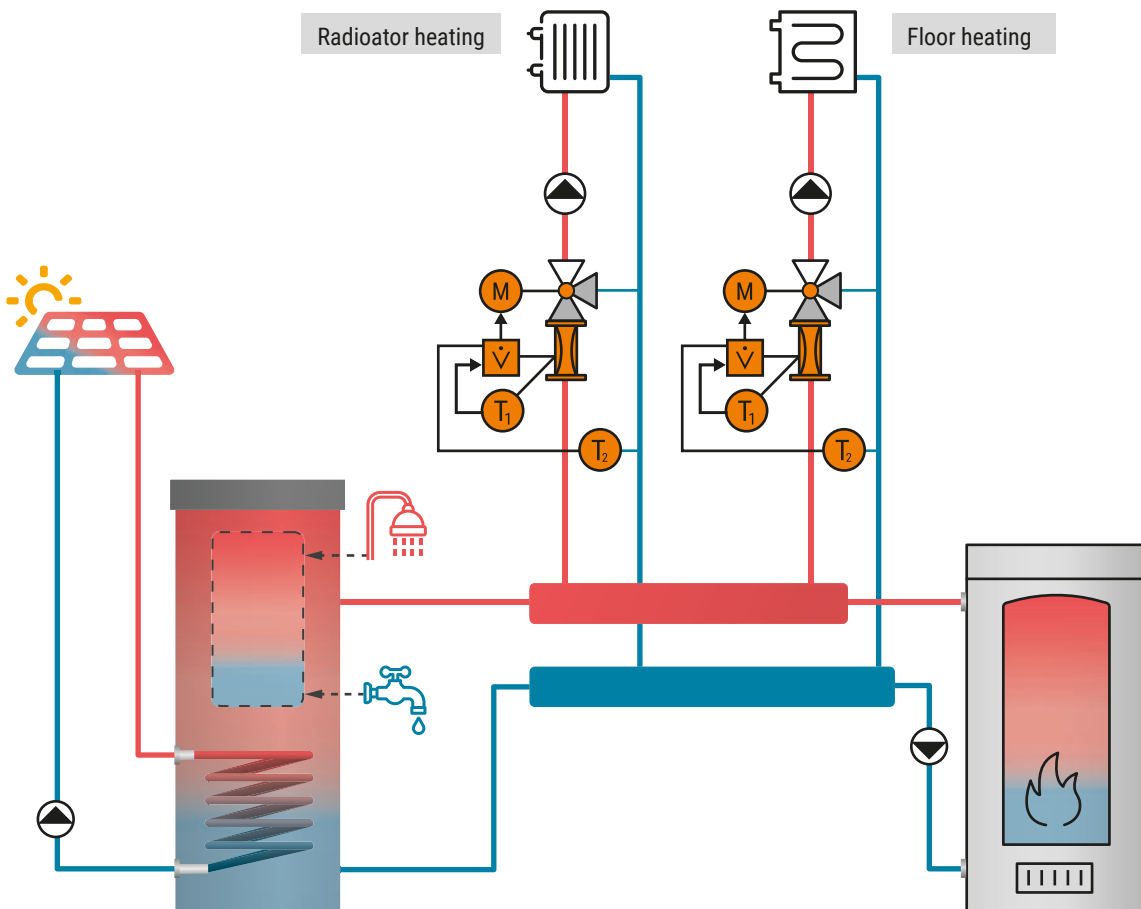
Non-condensing boilers are often fitted with a 3-way globe valve to prevent condensation forming in the boiler during commissioning, as this would lead to corrosion and, over time, boiler failure. In order to prevent condensation in all cases, the 3-way valve is partially designed in such a way that even after the heating process, a small amount still flows back into the return, as shown in Figure 116.

Solution: Energy Valve retrofit

Retrofitting the Energy Valve to an existing non-condensing boiler will help monitor your existing installation and allow the system to detect when the return water temperature is above the minimum value in order to close the bypass valve completely, as shown in Figure 117.

Problem: Poor energy efficiency of condensing boiler

Condensing boilers achieve high efficiency (usually over 90%) by



Abb. 116: Boiler with globe valve.

*Bypass valve to prevent condensation during start-up.

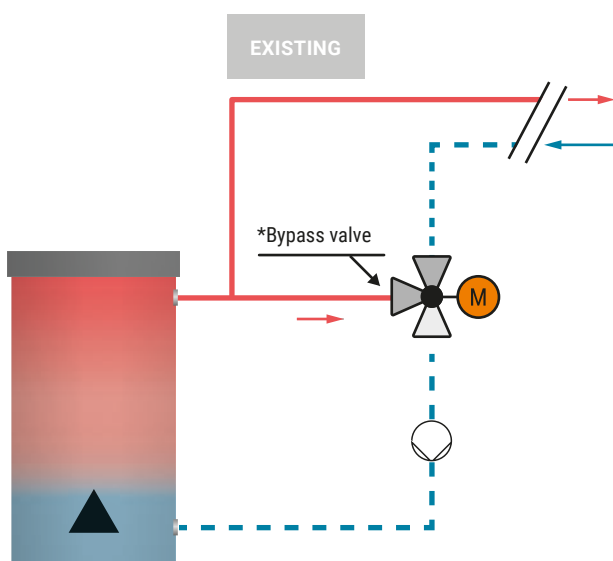

Abb. 117: A non-condensing boiler retrofitted with an air-bubbletight bypass valve and an Energy Valve.

condensing the water vapour in the exhaust gases and recovering the latent heat that would otherwise be lost. This condensed vapour leaves the system in liquid form, via a drain. The return water temperature to the boiler must be as far below the dew point of the supplied exhaust gas as possible so that the condensation process can take place. For oil condensing boilers, the dew point temperature is around 49 °C.

If coils or radiators are not able to transfer the required amount of energy, the resulting high return water temperatures prevent the desired condensation for energy recovery from occurring, which drastically reduces the efficiency of the boiler.

Solution: Boiler replacement and Energy Valve retrofit

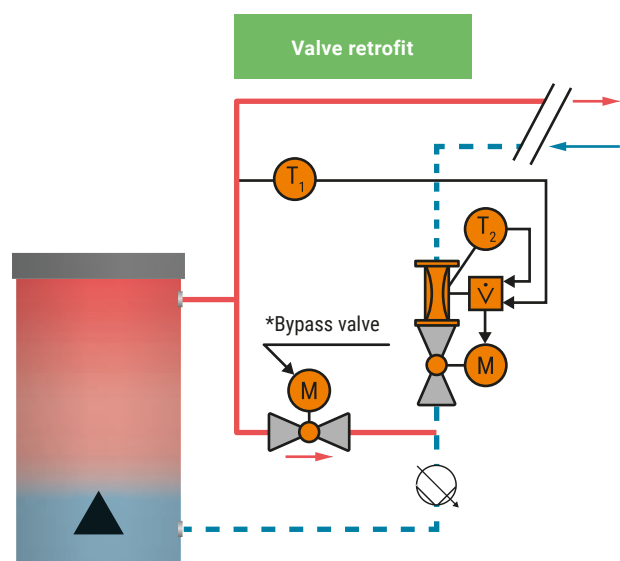
The use of Energy Valves on the consumers ensures that heat dissipation takes place in a controlled manner. Preventing excessively high flow rates through the heat exchangers also prevents excessively low temperature spreads and thus excessively high return temperatures.

Thanks to the Belimo Energy Valve™, you can now constantly monitor the return temperature of your consumers. You will be able to identify hydronic problems of your existing installations. These are often:

- Open bypass valves that flood your circuit with hot water and do not supply remote consumers
- Valves in closed positions that are leaking/passing, resulting in "ghost energy"
- Foul coils not able to transfer the required power
- Scale in potable hot water tanks
- Blocked strainers



Pro Tip

The type of fuel with which the condensing boiler is operated determines the ideal return water temperature.

8.4 Heating valve applications

The mixing circuit as well as the injection circuit with 2-way valve varies the water temperature upstream of the consumer. Adapting the supply temperature at the consumer controls the power output at the constant-volume heating coil. In the throttle circuit, the supply temperature to the heating coil is not varied. The heating power is controlled by the consumer changing the amount of water.



Abb. 118: An overview of the various basic hydronic circuits for heating applications.

9

Monitoring chillers and heat pumps

9.1 Application description

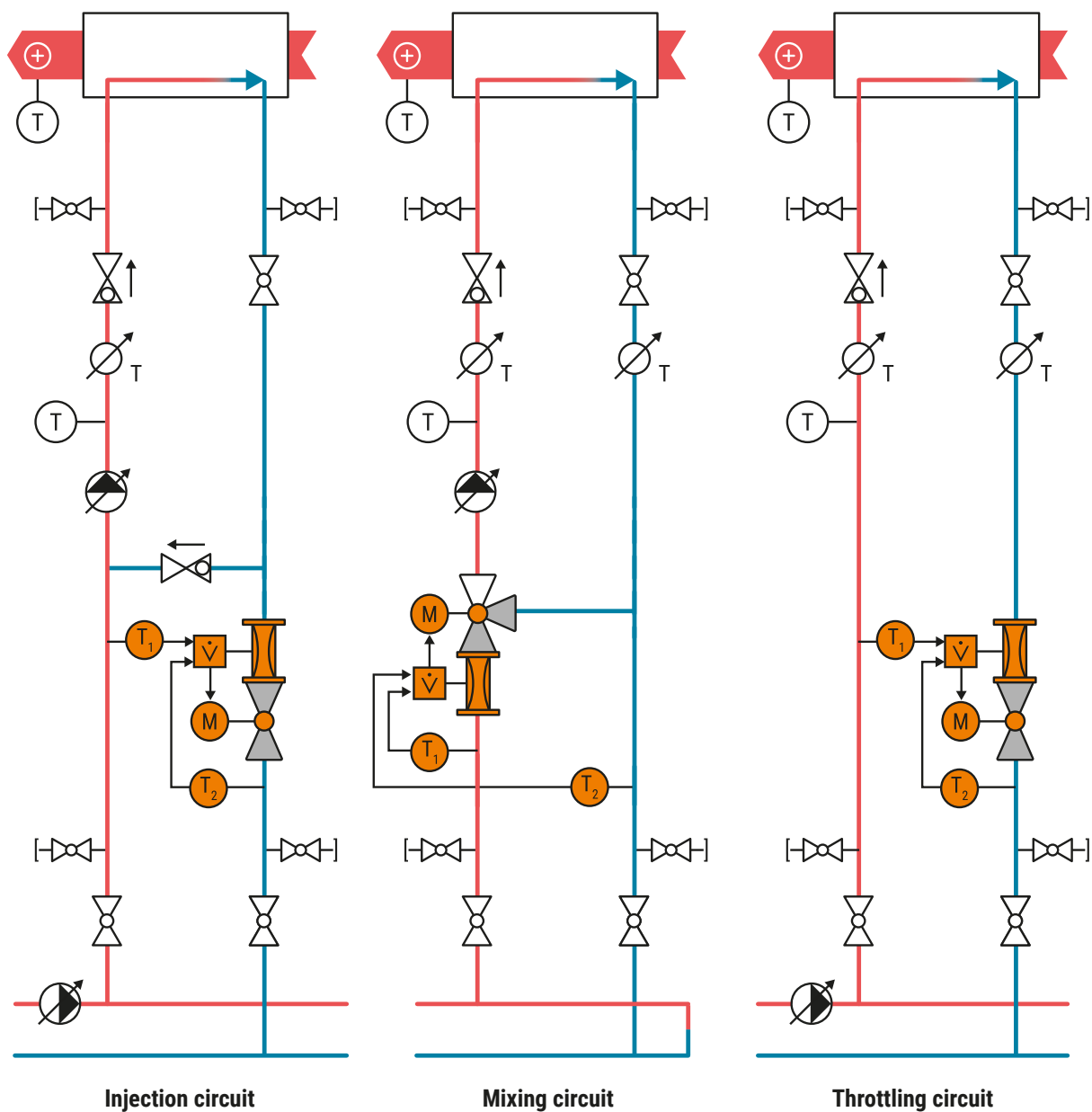
Chillers and heat pumps come in a huge variety of shapes and sizes, using different technology to achieve the same outcome for the exchange of energy.

The efficiency of this process is measured by the ratio of usable energy (thermal energy) to input energy (usually electricity).

Monitoring the water supply temperature, the flow rate, and the water return temperature is an important part of the process. The first step in improving the operating efficiency of chillers is to calculate the current coefficient of performance (power generated/electricity consumed), known as COP.



Abb. 120: Chiller with cooling circuit.

$$\text{COP} = \frac{\text{COOLING POWER}}{\text{INPUT POWER}}$$

Abb. 119: Standard efficiency calculation formula for a chiller. Further details and heat pump calculations can be found in the industry standards.

9.2 Schematic

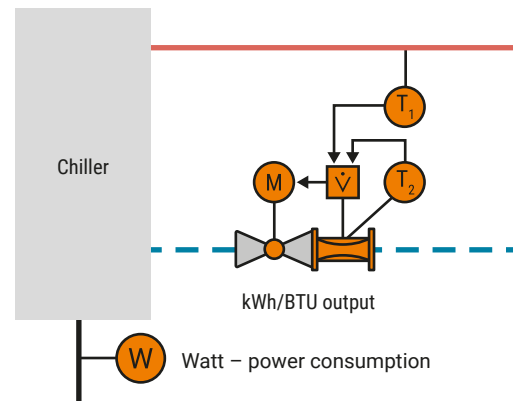
There is not one generic schematic valid for all kinds of chiller or heat pump piping. Figure 120 shows an Energy Valve fitted to monitor flow and delta T through a chiller.

However, they all have one thing in common, their maximum achievable power depends on the mass flow rate x spec. heat capacity x delta T. In low delta T situations, there are often more machines in operation than are actually needed because their efficiency is limited.

9.3 Total cost of ownership (TCO)

Often, a low delta T is presented as a lack of system capacity during peak periods. This naturally leads to the desire to increase capacity. Using the Energy Valve to diagnose and actively correct low delta T at the heat exchangers, can prevent the need to upgrade entirely.

9.4 Common problems with chillers and heat pumps and how the Belimo Energy Valve™ solves them

Problem: Ongoing monitoring of chiller performance

With older chillers it is difficult to monitor the performance. Ideally, this value is available and can be used in conjunction with the current consumption to calculate the COP value. Determining such KPIs is becoming increasingly important. The capability to measure performance against this time last year or against a time with similar conditions, enhances informed decisions on maintenance and replacement.

Solution: Use the integrated energy meter of the Belimo Energy Valve™

By monitoring the flow rate and entering and leaving water temperatures, you can get a good idea of how well your chiller is working thermally. And with an additional meter for current consumption, you get a complete picture or coefficient of performance (COP). Even if your chiller already offers real-time data, the Energy Valve can log this data for 13 months, thus providing useful support.

Problem: Unknown glycol levels

Glycol is heavier than water, so too much will reduce the efficiency of the pump. If the quantity is too small, there is a risk of freezing. To achieve the ideal level, the water must be tested. This is often a manual process and building management staff must remember to carry out these tests. To avoid carrying out this process, the glycol is often overdosed.

Solution: Continuous glycol monitoring

The primary chilled water circuit is the best place to monitor the levels of this important part of your water. Energy Valves measure the glycol concentration in the hydronic circuit and the BMS can trigger an alarm or even automatically dose the system if the level falls below a certain limit value.

By monitoring and logging the glycol content, you can manage the balance between too excessive and insufficient concentrations in the system.

The Energy Valves automatically adjust the thermal energy calculation to the level and type of glycol in the system. Without this adaptation, the measured values could be influenced by 30%.



Abb. 121: COP analyses are possible only when data are logged.



Abb. 122: Integrated energy data logging.



Abb. 123: Fear of pipeline failure is often the reason for overdosing glycol and the resulting increased energy consumption of the pumps.

9.5 Success story

Belimo Energy Valve™ cures low delta T syndrome at university hospital

The University of Miami medical campus (USA) saves thousands of dollars and increases plant capacity by retrofitting with Energy Valves from Belimo.

Miller School of Medicine

The University of Miami's Miller School of Medicine takes pride in bringing medical research from 'bench to bedside'. Their patients in Southern Florida are treated with the help of the latest innovations in medical technology. On its sprawling campus and in its state-of-the-art buildings, doctors and researchers are unlocking secrets, not only to infectious diseases but also the future of stem cells and genetics.

What many people probably do not know are the preventive care measures that are taken behind the scenes regarding the clinic's technical building systems. The centrepiece of the university is a chilling plant covering an area of 4,370 m² with a capacity of 42 MW. It supplies hospitals and research buildings with the necessary cold water. The relatively new chiller was not commissioned until 2011, but some buildings on campus were operating less efficiently than expected, wasting thousands of litres of cold water. However, the problem was not with the chiller plant, but the cooling coils in several of the campus facilities.

The solution to the problem came in the form of the latest research and development from Belimo – the Belimo Energy Valve™.

The diagnosis – low delta T

Low delta T is a common hydronic problem. It occurs when the heat exchanger is operated with too much water or is contaminated. Inadequate hydronic balancing or incorrectly installed and controlled ventilation systems can also contribute to low delta T.

When this happens, air handler efficiency and heat transfer plummet. In turn, chillers and pumps work overtime in order to maintain a given temperature setpoint. Return water temperature to the chiller is lower than the intended design, forcing more water to be pumped through the system. As more and more gallons of water move through the system, not only is efficiency in question, but utility costs can go through the roof.

This was the diagnosis for some of the buildings on the University of Miami medical campus. Despite a new chiller and a mix of old and new buildings, low delta T had reduced energy efficiency on campus. At least until Kerney and Associates from Dania Beach, Florida, stepped in.



Abb. 124: The University of Miami's medical campus.

The company, which specialises in piping systems and energy services, had been servicing the University of Miami clinic for several years. When the company learned about the new Belimo Energy Valve™, it was clear that it needed to inform the university about it. This is because Kerney and Associates specialise in retrofit opportunities that maximise return on investment for their clients.

"We do a lot of business with them," says Ron Bogue, Assistant Vice President for Facilities and Services at the University of Miami School of Medicine. "They came to us and introduced us to the Belimo Energy Valve."

The Energy Valve is a pressure-independent valve that registers and optimises water coil performance. The valve includes an ultrasonic flow sensor and temperature sensors that monitors supply and return water. Differential temperature is monitored to make sure that the delta T in the heat exchanger is maintaining the desired setpoint. If delta T drops, the valve modulates the flow of water at the coil, which improves system efficiency.

PART C

Installation and Configuration

OVERVIEW OF SETTINGS

1 **Parametrisation** 116

2 **Glossary** 118

1

Parametrisation

1.1 Delivery condition

Factory reset

The product is shipped with the default settings, as shown below. The flow rates and control modes must be set on site, but this is easy to do via the Belimo Assistant App or the web server.

Maximum Flow	Installation position	Delta T manager	Actuator Setup	Control and feedback	Control mode
Maximum flow of the valve	Return	Off	Non-fail-safe normally closed (NC)	Control signal (Y) DC 2 to 10 V	Flow rate control
			Electronic fail-safe, normally closed (NC)/fail-safe position closed	Feedback Signal (U) DC 2 to 10 V	

Abb. 125: Default settings of the Belimo Energy Valve™.

2

Glossary

Analogue signal

A linear signal from one device to another, which is used to write or read values. For example, a controller may use an analogue signal to modulate an actuator. Typical analogue signal ranges for HVAC applications are DC 2...10 V, DC 0...10 V or 4...20 mA.

ASHRAE 90.1

An American National Standard issued by ASHRAE and co-sponsored by IES, which provides minimum requirements for the energy-efficient design of buildings, excluding low-rise residential buildings.

BACnet

A standard worldwide communication protocol that is used in building automation. BACnet IP communicates via Ethernet networks and BACnet MS/TP, over 2 or 3-wire RS-485 networks.

Calculated/theoretical flow

A calculated and therefore theoretical flow is obtained by assuming a flow rate based on valve position. This method is not precise as all requirements for pressure need to be met. Often used with mechanical PI valves.

BMS (Building Management System) and BAS (Building Automation System)

A computer-based controls system installed in buildings to control and monitor the building's mechanical and electrical equipment.

Delta T, ΔT , or DT

The differential temperature between the supply and return media. In HVAC applications, delta T is usually the difference in the temperature of the air or water after it passes through a heat transfer device.

Delta T limit value

Setting used by the delta T manager to prevent the coil from operating at too high a flow rate.

Delta T manager

Belimo-patented flow-limitation logic applied to the Energy Valve control modes.

Delta T setpoint

The setpoint used by the Delta T Manager logic. When used with Delta T Manager, it is a fixed setting. When used with delta T manager scaling, it becomes a calculated variable across a scaled range.

DDC controller (direct digital control)

An electronic controller with software to operate control valves, dampers and other devices.

Pressure-independent VAV

A pressure-independent VAV controller measures the airflow and maintains it independently of the static inlet pressure of the primary air handling unit.

Flow limit value/flow rate at saturation

A setting used with delta T manager scaling to reset the delta T limit value, and create a variable, delta T setpoint.

Dynamic balancing

A method that compensates all pressure fluctuations in the system, to make sure the required flow is delivered to each point in the system.

EPIV

Electronic pressure-independent characterised control valve with real-time flow measurement via ultrasonic time-of-flight technology.

Belimo Energy Valve™

A smart control valve consisting of an ultrasonic flow sensor, a characterised control valve, an actuator, two temperature sensors and an embedded control logic, which allows for power control in a hydronic circuit.

Fixed Delta T Manager

An option in the Delta T Manager logic that produces a fixed delta T setpoint.

Equal percentage flow curve

An equal percentage flow characteristic is a non-linear curve where the slope increases as the valve opens, while a linear flow characteristic is a straight line.

Hysteresis

A phenomenon typically associated with the springs in mechanical PI valves. When pressure changes, a spring which controls the diaphragm position starts to be compressed or stretched, therefore maintaining the PI functionality and impacting very little on the control device, resulting in a minor variation of flow.

KPI

A key performance indicator is a type of performance measurement. In our context, the KPIs evaluate the influences on the hydronic system by the Belimo Energy Valve™.

PI valves, PIV, or PICV

Designation for pressure-independent control valves.

P'max

The maximum thermal power setting.

P'nom

The maximum capacity of the heat exchanger that can be controlled by the Energy Valve (catalogue value, depending

on nominal size).

PT connections

Pressure and temperature connections on one device, by means of which the two variables can be measured.

Transit time technology

The transit time method of measurement is the most commonly used in ultrasonic metering. One or more pulses are transferred through the fluid to and from the transducers to the opposite transducer, which is further downstream. Sound waves travel faster with the direction of flow and slower against the direction of flow. This principle is used for the measurement.

Modbus

A type of bus communication that can integrate the device to the controller over a bus. It can be wired in either RTU or IP configuration.

MP-Bus or MP

Belimo MP-Bus is a combined 24 V power and signal standard for connecting a primary actuator with up to 16 secondary actuators. It can also be used with the ZTH EU tool to view and change the actuator settings.

Wet calibrated

A sensor calibration method using actual fluid flow. This method usually provides the highest calibration accuracy for a flow sensor and is used when accuracy is a primary concern or when the form of the meter does not lend itself to other methods.

CCV (Characterized Control Valve)

A ball valve from Belimo with characterised disc that offers an equal-percentage flow characteristic with a high setting range, zero leakage, and high level of tightness.

Coil

A water to air heat exchanger, typically made of copper tubes passed through aluminium fins, and is used in AHUs, fan coils, etc.

AHU (air handling unit)

A device used to condition and circulate air as part of a heating, ventilating, and air-conditioning system.

Delta T manager scaling

An option in the Delta T Manager logic that produces a variably scaled delta T setpoint.

Variable flow systems

A type of system that delivers variable water depending on the required load.

True flow

An accurate flow rate as obtained from a wet calibrated flow sensor.

VAV (variable air volume)

VAV is a type of HVAC system. VAV systems vary the airflow to provide a constant room temperature and/or a certain air volume per hour.

Valve authority

A term used to describe the basis on which a control valve is selected. The valve authority is generally defined as the ratio of the pressure drop across the fully open valve in comparison to the pressure drop across the entire variable-flow path of the circuit at design flow conditions.

Flow coefficient (kv value)

The kv value is also called the flow factor or the flow coefficient. It is a measure of the achievable flow rate of a fluid (or gas) through a valve and is used for valve selection and dimensioning. The flow coefficient always refers to a pressure drop over the valve of 100 kPa/1 bar.

V'max

The maximum flow setting of the valve adjusted to the requirements of the application. A value inputted to set the maximum flow to be delivered by the valve.

V'nom

The maximum flow rate that can be controlled by the Energy Valve (catalogue value).

NOTES



NOTES



NOTES



All inclusive.

Belimo is the global market leader in the development, production and sales of field devices for energy-efficient control of heating, ventilation and air-conditioning systems. Damper actuators, control valves, sensors and meters make up the company's core business.

Always focusing on customer value, we deliver more than only products. We offer you the complete product range of actuator and sensor solutions for the regulation and control of HVAC systems from a single source. At the same time, we rely on tested Swiss quality with a five-year warranty. Our worldwide representatives in over 80 countries guarantee short delivery times and comprehensive support through the entire product life. Belimo does indeed include everything.

The "small" Belimo devices have a big impact on comfort, energy efficiency, safety, installation and maintenance.

In short: Small devices, big impact.



5-year warranty



On site around the globe



Complete product range



Tested quality



Short delivery times



Comprehensive support



BELIMO Automation AG

Brunnenbachstrasse 1, 8340 Hinwil, Switzerland
+41 43 843 61 11, info@belimo.ch, www.belimo.com

BELIMO[®]