

Silencer UOS-1

FESTO

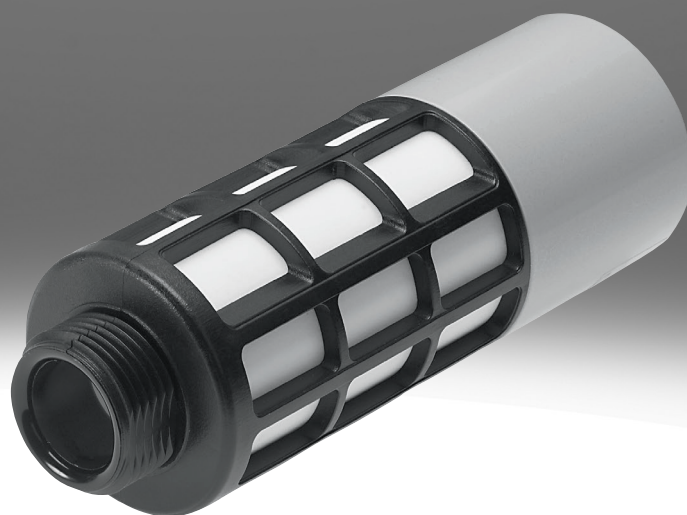

Characteristics

At a glance

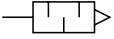

To reduce noise and prevent contamination at the exhaust ports of pneumatic components.

- Open silencer for MS6-SV, MS series (order code in modular product system: SO)
- Operating medium: compressed air

Note: Clean silencers with paraffin (not with petrol or trichloroethylene).

Flow rate characteristic

[] None

[LF] Low flow

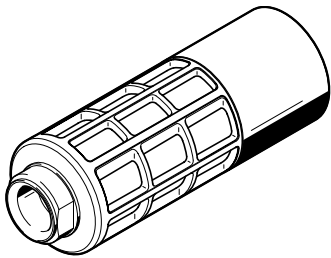

For high exhaust rate

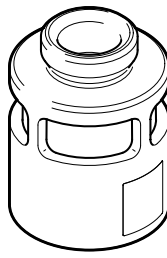

For low exhaust rate

Note: The compact silencer UOS-1-LF may only be used for applications with lower exhaust rates. Pneumatic port 2 at the soft-start/quick exhaust valve MS6-SV-D/E must be reduced to G1/4 by a connecting plate MS6-AGB.

Type code

001	Series	
UOS	Silencer	
002	Pneumatic connection	
1	G1	

003	Flow rate characteristic	
	None	
LF	Low flow	

Datasheet

General technical data

Pneumatic connection	G1
Design	Open silencer
Type of mounting	Via male thread
Mounting position	optional
Type of seal on screwed plug	No seal

Operating and environmental conditions

Operating pressure	0 ... 1 MPa
Operating pressure	0 ... 10 bar
Operating pressure	0 ... 145 psi
Operating medium	Compressed air to ISO 8573-1:2010 [:-:-]
Ambient temperature	-10 ... 50°C
Corrosion resistance class CRC ¹⁾	2 - Moderate corrosion stress

1) More information: www.festo.com/x/topic/crc

Materials

Short type code	UOS-1-LF	USO-1
Material housing	Wrought aluminium alloy	POM
Material sleeve	–	Wrought aluminium alloy
Material shock absorber insert	PE	
Note on materials	RoHS-compliant	
LABS (PWIS) conformity	VDMA24364-B1/B2-L	

Dimensions

Dimensions – Dimensions UOS-1

Download CAD data → www.festo.com

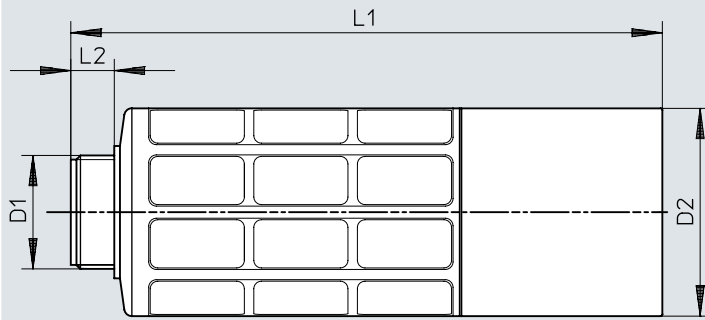

[1] Barbed connector for tubing, inside- \varnothing 3

		D1	D2 \varnothing	L1	L2
UOS-1	MS6-SV-D/E	G1	55	156,5	11,5

Dimensions

Dimensions – UOS-1-LF

Download CAD data → www.festo.com

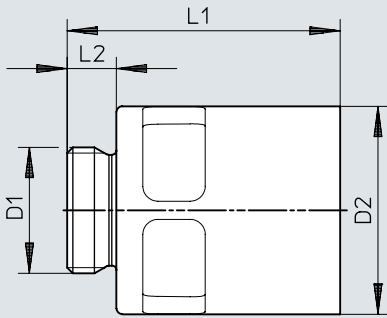

[1] Barbed connector for tubing, inside- \varnothing 4

		D1	D2 \varnothing	L1	L2
UOS-1-LF	MS6-SV-D/E	G1	55	72,2	13

Ordering data

Ordering data – Version for high exhaust capacity

	Pneumatic connection	Sound pressure level	Product weight	Part no.	Type
	G1	75 dB(A)	200 g	552252	UOS-1

Ordering data – Version for low exhaust capacity

	Pneumatic connection	Sound pressure level	Product weight	Part no.	Type
	G1	75 dB(A)	157.9 g	1901207	UOS-1-LF