

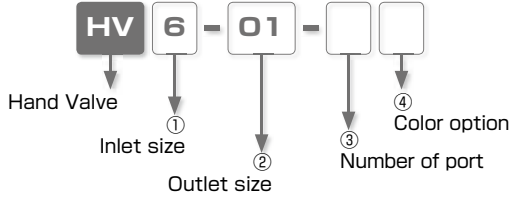

Push-In Fitting Type Shut-off Valve (Residual Pressure Release Valve)
Hand Valve Series

- *Control Open/Close for Air Supply.*
- *Release Residual Pressure by Three-Directional Control Valve*
- *4 Type Selections for Various Application*

Model Designation (Example)



① Inlet size

	mm Tube dia. (mm)					Inch Tube dia.(mm)			Taper pipe thread size			
Code	4	6	8	10	12	1/4	5/16	3/8	01	02	03	04
Size	ø4	ø6	ø8	ø10	ø12	ø6.35	ø7.94	ø9.53	R1/8	R1/4	R3/8	R1/2

② Outlet size

	mm Tube dia. (mm)					Inch Tube dia.(mm)			Taper pipe thread size			
Code	4	6	8	10	12	1/4	5/16	3/8	01	02	03	04
Size	ø4	ø6	ø8	ø10	ø12	ø6.35	ø7.94	ø9.53	R1/8	R1/4	R3/8	R1/2

③ Number of port

No code: Three-directional control valve

2: Two-directional control valve

④ Color option

No code: Standard color (Cap lever: Blue / Resin body and Release ring: Black)

W: Light-gray (Cap lever/ Resin body and Release ring)

Three-directional control valve and Two-directional control valve

Three-directional control valve has a function to release residual pressure in outlet side after stopping air supply. Adjustment or maintenance can be carried out safely.

Two-directional control valve does not have a function to release the residual pressure in outlet side. This valve is suitable for applications such as tanks which are required to keep the residual pressure.

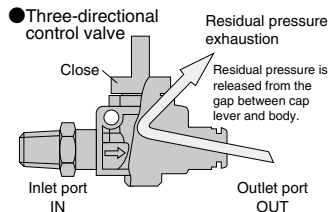

Identification between Three-directional control valve and Two-directional control valve

Check the marking on the cap lever

③: Three-directional control valve

②: Two-directional control valve

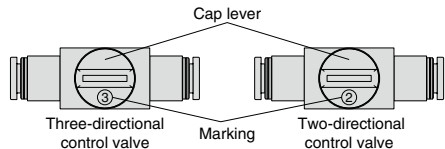

Specifications

Fluid medium	Air
Operating pressure range	0 ~ 0.9MPa
Max. vacuum	-100kPa
Operating temp. range	0 ~ 60°C (No freezing)

Construction (Straight B (Cap lever: Close))

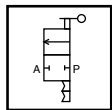

Symbol of Two-directional control valve

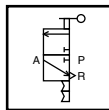

Symbol of Three-directional control valve

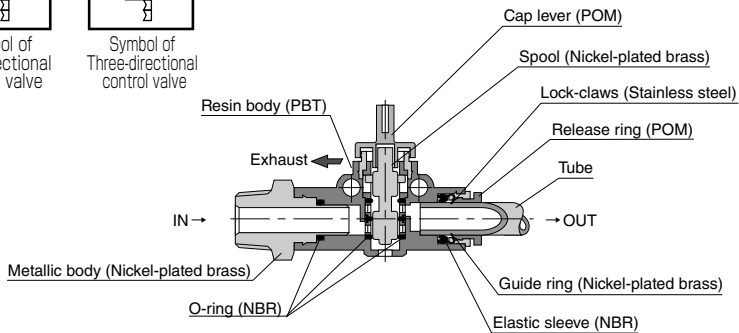

△ Detailed Safety Instructions

Before using PISCO products, be sure to read "Safety Instructions" and "Safety Instruction Manual" on page 23 to 27 and "Common Safety Instructions for Valves" on page 549 to 550.

1. Make sure to turn the cap lever 90 degrees. Inadequate turning can cause a poor path connection or a lack of flow amount. Excessive turning can cause damage to Hand Valve.
2. Distinguish between Three-directional control valve and Two-directional control valve by marking on the cap lever.
3. When Hand Valves is used under negative pressure, place a vacuum filter on the inlet side. Vacuumed dusts can cause malfunction of pneumatic systems.

Standard Size List

Connection: Thread ⇔ Tube

Type	Page	Inlet tube dia.	Outlet thread size				
			R1/8	R1/4	R3/8	R1/2	
HV Straight A	P.561	6	●	●	●		
		8	●	●	●		
		10		●	●	●	
		12		●	●	●	
		1/4		●	●	●	
		5/16		●	●	●	
		3/8			●	●	●

Type	Page	Inlet thread size	Outlet tube dia.						
			6	8	10	12	1/4	5/16	3/8
HV Straight B	P.562	R1/8	●	●					
		R1/4	●	●	●	●	●	●	●
		R3/8	●	●	●	●	●	●	●
					●	●			
		R1/2			●	●			●

Connection: Thread ⇔ Thread

Type	Page	Inlet tube dia.	Outlet tube dia.							
			4	6	8	10	12	1/4	5/16	3/8
HV Union Straight	P.563	4	●							
		6		●						
		8			●					
		10				●				
		12					●			
		1/4						●		
		5/16							●	
		3/8								●

Connection: Thread ⇔ Thread

Type	Page	Inlet thread size	Outlet thread size		
			R1/8	R1/4	R3/8
HV Nipple	P.563	R1/8	●		
		R1/4	●	●	
				●	
		R3/8			●

Cap lever operation

1. Open the valve

To open the valve, turn the cap lever 90 degrees in the clockwise direction until it stops.

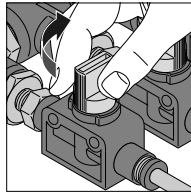

2. Close the valve

To close the valve, turn the cap lever 90 degrees in the counterclockwise direction until it stops. As for three-directional control valve, the residual pressure in outlet side is released from the gap between cap lever and body just after closing the valve.

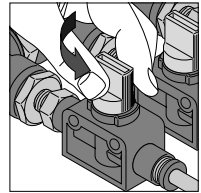

How to insert and disconnect

1. How to insert and disconnect tubes

① Tube insertion

Insert a tube into Push-In Fitting up to the tube end. Lock-claws bite the tube and fix it automatically, then the elastic sleeve seals around the tube.

Refer to "2. Instructions for Tube Insertion" under "Common Safety Instructions for Fittings".

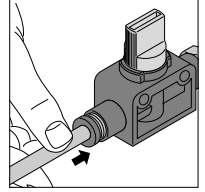

② Tube disconnection

The tube is disconnected by pushing release-ring to release Lock-claws.

Make sure to stop air supply before the tube disconnection.

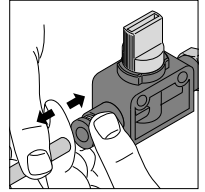

2. How to tighten thread and fix a valve body

① Tightening thread

Use a spanner to tighten a hexagonal-column of Hand Valve Straight A, B and Straight Thread type.

Refer to "Table: Recommended tightening torque" under "2. Instructions for Installing Valves" in "Common Safety Instructions for Valves".

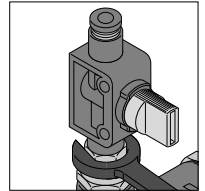

② How to fix valve body

In order to fix a valve body of Hand valve Union straight, use the fixing holes on the body to tighten with M4 screw. Refer to the dimensional drawings for the hole pitch.

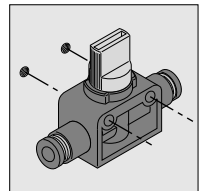

Applicable Tube and Related Products

Polyurethane Tube.....P.596

Nylon Tube.....P.608

RoHS compliant

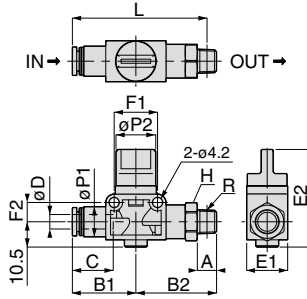

Unit : mm

Model code	Tube O.D. øD	R	A	E1	E2	L	øP1	øP2	Tube end C	B1	B2	Hex. H	F1	F2	Effective area (mm ²)	Weight (g)	CAD file name
HV6-01-□□	6	R1/8	8			55.9									7.5	34	HV6-01_
HV6-02-□□		R1/4	11	17	40.5	56.8	12.5	16.5	17	26.4	36.5	14	18	8	7.7	40	HV6-02_
HV6-03-□□		R3/8	12				58.3					38.3	17			7.5	53
HV8-01-□□	8	R1/8	8			57.2									8.7	35	HV8-01_
HV8-02-□□		R1/4	11	17	40.5	58.2	15	16.5	18.1	27.7	36.5	14	18	8	8.9	41	HV8-02_
HV8-03-□□		R3/8	12				59.7					38.3	17			8.6	54
HV10-02-□□	10	R1/4	11			68.7									16.2	62	HV10-02_
HV10-03-□□		R3/8	12	21.7	41	69.4	17.5	19.5	20.2	32.2	43.5	17	24	11	16	71	HV10-03_
HV10-04-□□		R1/2	15				70.5					46.5	21			15.7	93
HV12-02-□□	12	R1/4	11			71.4									16.3	66	HV12-02_
HV12-03-□□		R3/8	12	21.7	41	72.1	21	19.5	23.4	34.9	43.5	17	24	11	16.1	74	HV12-03_
HV12-04-□□		R1/2	15				73.2					46.5	21			16.1	96
HV14-01-□□	1/4	R1/8	8			55.9									8.2	34	HV14-01_
HV14-02-□□		R1/4	11	17	40.5	56.8	12.5	16.5	17	26.4	36.5	14	18	8	8	40	HV14-02_
HV14-03-□□		R3/8	12				58.3					38.3	17			8.2	53
HV5/16-01-□□	5/16	R1/8	8			57.2									8.7	35	HV5/16-01_
HV5/16-02-□□		R1/4	11	17	40.5	58.2	15	16.5	18.1	27.7	36.5	14	18	8	8.9	41	HV5/16-02_
HV5/16-03-□□		R3/8	12				59.7					38.3	17			8.6	54
HV3/8-02-□□	3/8	R1/4	11			68.7									15.4	63	HV3/8-02_
HV3/8-03-□□		R3/8	12	21.7	41	69.4	17.5	19.5	20.2	32.2	43.5	17	24	11	15.7	71	HV3/8-03_
HV3/8-04-□□		R1/2	15				70.5					46.5	21			15.4	93

※ "L" is a reference value for height dimension after tightening thread.

※ Left □ in Model code / Replaced with "2" for Two-directional control valve , or remained blank for Three-directional control valve

※ Right □ in Model code / Replaced with "W" for Light-gray color, or remained blank for standard color.

HV Straight B

RoHS compliant

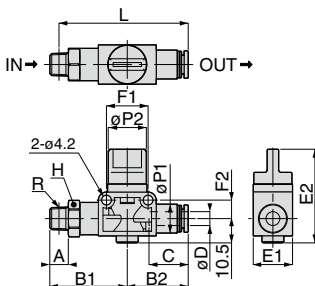

Unit : mm

Model code	Tube O.D. øD	R	A	E1	E2	L	øP1	øP2	Tube end C	B1	B2	Hex. H	F1	F2	Effective area (mm ²)	Weight (g)	CAD file name	
HV01-6-□□	6	R1/8	8			55.9				33.5		14	18	8	8.3	34	HV01-6_	
HV02-6-□□		R1/4	11	17	40.5	56.8	12.5	16.5	17	36.5	26.4				17	8.5	40	HV02-6_
HV03-6-□□		R3/8	12			58.3				38.3						8.2	53	HV03-6_
HV01-8-□□	8	R1/8	8			57.2				33.5		14	18	8		35	HV01-8_	
HV02-8-□□		R1/4	11	17	40.5	58.2	15	16.5	18.1	36.5	27.7				17	8.9	41	HV02-8_
HV03-8-□□		R3/8	12			59.7				38.3						54	HV03-8_	
HV02-10-□□	10	R1/4	11			68.7				42.5		17	24	11	16.6	62	HV02-10_	
HV03-10-□□		R3/8	12	21.7	41	69.4	17.5	19.5	20.2	43.5	32.2				21	16.9	71	HV03-10_
HV04-10-□□		R1/2	15			70.5				46.5						16.5	93	HV04-10_
HV02-12-□□	12	R1/4	11			71.4				42.5		17	24	11	17	66	HV02-12_	
HV03-12-□□		R3/8	12	21.7	41	72.1	21	19.5	23.4	43.5	34.9				21	17.1	74	HV03-12_
HV04-12-□□		R1/2	15			73.2				46.5						16.8	96	HV04-12_
HV01-1/4-□□	1/4	R1/8	8			55.9				33.5		14	18	8	8.7	34	HV01-1/4_	
HV02-1/4-□□		R1/4	11	17	40.5	56.8	12.5	16.5	17	36.5	26.4				17	8.4	40	HV02-1/4_
HV03-1/4-□□		R3/8	12			58.3				38.3						8.5	53	HV03-1/4_
HV01-5/16-□□	5/16	R1/8	8			57.2				33.5		14	18	8		35	HV01-5/16_	
HV02-5/16-□□		R1/4	11	17	40.5	58.2	15	16.5	18.1	36.5	27.7				17	8.9	41	HV02-5/16_
HV03-5/16-□□		R3/8	12			59.7				38.3						54	HV03-5/16_	
HV02-3/8-□□	3/8	R1/4	11			68.7				42.5		17	24	11	16.5	63	HV02-3/8_	
HV03-3/8-□□		R3/8	12	21.7	41	69.4	17.5	19.5	20.2	43.5	32.2				21	16.8	71	HV03-3/8_
HV04-3/8-□□		R1/2	15			70.5				46.5						16.6	93	HV04-3/8_

※ "L" is a reference value for height dimension after tightening thread.

※ Left □ in Model code / Replaced with "2" for Two-directional control valve , or remained blank for Three-directional control valve

※ Right □ in Model code / Replaced with "W" for Light-gray color, or remained blank for standard color.

VALVE
TUBE

MAKE-TO-ORDER
PRODUCTS

562

Shut-off Valve

Mechanical Valve

HV Union Straight

RoHS compliant

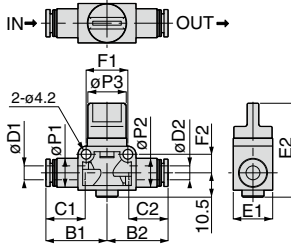

Unit : mm

Model code	Tube O.D. øD1	Tube O.D. øD2	E1	E2	øP1	øP2	øP3	Tube end C1	Tube end C2	B1	B2	F1	F2	Effective area (mm ²)	Weight (g)	CAD file name
HV4-4-□□	4	4	17	40.5	10	10	16.5	14.9	14.9	25.8	25.8	18	8	3.4	24	HV4-4_
HV6-6-□□	6	6	17	40.5	12.5	12.5	16.5	17	17	26.4	26.4	18	8	7.2	25	HV6-6_
HV8-6-□□	8	6	17	40.5	15	12.5	16.5	18.1	17	27.7	26.4	18	8	8.1	26	HV8-6_
HV8-8-□□		8				15			18.1							
HV10-10-□□	10	10	21.7	41	17.5	17.5	19.5	20.2	20.2	32.2	32.2	24	11	17.4	45	HV10-10_
HV12-10-□□	12	10	21.7	41	21	17.5	19.5	23.4	20.2	34.9	32.2	24	11	17.5	48	HV12-10_
HV12-12-□□		12				21			23.4							
HV1/4-1/4-□□	1/4	1/4	17	40.5	12.5	12.5	16.5	17	17	26.4	26.4	18	8	8.1	25	HV1/4-1/4_
HV5/16-1/4-□□	5/16	1/4	17	40.5	15	12.5	16.5	18.1	17	27.7	26.4	18	8	8.8	26	HV5/16-1/4_
HV5/16-5/16-□□		5/16				15			18.1							
HV3/8-3/8-□□	3/8	3/8	21.7	41	17.5	17.5	19.5	20.2	20.2	32.2	32.2	24	11	17	45	HV3/8-3/8_
HV1/2-3/8-□□	1/2	3/8	21.7	41	21	17.5	19.5	23.4	20.2	34.9	32.2	24	11	17.5	46.6	HV1/2-3/8_
HV1/2-1/2-□□		1/2				21			23.4							

※ Left □ in Model code / Replaced with "2" for Two-directional control valve , or remained blank for Three-directional control valve

※ Right □ in Model code / Replaced with "W" for Light-gray color, or remained blank for standard color.

HV Nipple

RoHS compliant

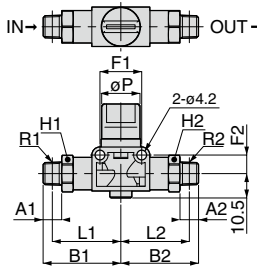

Unit : mm

Model code	R1	R2	A1	A2	E1	E2	L1	L2	øP	B1	B2	Hex. H1	Hex. H2	F1	F2	Effective area (mm ²)	Weight (g)	CAD file name
HV01-01-□□	1/8	1/8	8	8	17	40.5	29.5	29.5	16.5	33.5	33.5	14	14	18	8	8.8	43	HV01-01_
HV02-01-□□	1/4	1/8	11	8	17	40.5	30.5	29.5	16.5	36.5	33.5	14	14	18	8	9	49	HV02-01_
HV02-02-□□		1/4		11	21.7	41	36.5	36.5	19.5	42.5	42.5	17	17	24	11	15.8	80	HV02-02_
HV03-02-□□	3/8	1/4	12	11	21.7	41	37.2	36.5	19.5	43.5	42.5	17	17	24	11	15.6	88	HV03-02_
HV03-03-□□		3/8		12	37.2	43.5												

※ "L1" and "L2" are reference values for height dimensions after tightening taper thread.

※ Left □ in Model code / Replaced with "2" for Two-directional control valve , or remained blank for Three-directional control valve

※ Right □ in Model code / Replaced with "W" for Light-gray color, or remained blank for standard color.



SAFETY Instructions

This safety instructions aim to prevent personal injury and damage to properties by requiring proper use of PISCO products.

Be certain to follow ISO 4414 and JIS B 8370

ISO 4414 : Pneumatic fluid power...Recommendations for the application of equipment to transmission and control systems.

JIS B 8370 : General rules and safety requirements for systems and their components.

This safety instructions is classified into "Danger", "Warning" and "Caution" depending on the degree of danger or damages caused by improper use of PISCO products.



Danger

Hazardous conditions. It can cause death or serious personal injury.



Warning

Hazardous conditions depending on usages. Improper use of PISCO products can cause death or serious personal injury.



Caution

Hazardous conditions depending on usages. Improper use of PISCO products can cause personal injury or damages to properties.



Warning

1. Selection of pneumatic products

- ① A user who is a pneumatic system designer or has sufficient experience and technical expertise should select PISCO products.
- ② Due to wide variety of operating conditions and applications for PISCO products, carry out the analysis and evaluation on PISCO products. The pneumatic system designer is solely responsible for assuring that the user's requirements are met and that the application presents no health or safety hazards. All designers are required to fully understand the specifications of PISCO products and constitute all systems based on the latest catalog or information, considering any malfunctions.

2. Handle the pneumatic equipment with enough knowledge and experience

- ① Improper use of compressed air is dangerous. Assembly, operation and maintenance of machines using pneumatic equipment should be conducted by a person with enough knowledge and experience.

3. Do not operate machine / equipment or remove pneumatic equipment until safety is confirmed.

- ① Make sure that preventive measures against falling work-pieces or sudden movements of machine are completed before inspection or maintenance of these machine.
- ② Make sure the above preventive measures are completed. A compressed air supply and the power supply to the machine must be off, and also the compressed air in the systems must be exhausted.
- ③ Restart the machines with care after ensuring to take all preventive measures against sudden movements.

Disclaimer

1. PISCO does not take any responsibility for any incidental or indirect loss, such as production line stop, interruption of business, loss of benefits, personal injury, etc., caused by any failure on use or application of PISCO products.
2. PISCO does not take any responsibility for any loss caused by natural disasters, fires not related to PISCO products, acts by third parties, and intentional or accidental damages of PISCO products due to incorrect usage.
3. PISCO does not take any responsibility for any loss caused by improper usage of PISCO products such as exceeding the specification limit or not following the usage the published instructions and catalog allow.
4. PISCO does not take any responsibility for any loss caused by remodeling of PISCO products, or by combinational use with non-PISCO products and other software systems.
5. The damages caused by the defect of Pisco products shall be covered but limited to the full amount of the PISCO products paid by the customer.



SAFETY INSTRUCTION MANUAL

PISCO products are designed and manufactured for use in general industrial machines. Be sure to read and follow the instructions below.

⚠ Danger

1. Do not use PISCO products for the following applications.
 - ① Equipment used for maintaining / handling human life and body.
 - ② Equipment used for moving / transporting human.
 - ③ Equipment specifically used for safety purposes.

⚠ Warning

1. Do not use PISCO products under the following conditions.
 - ① Beyond the specifications or conditions stated in the catalog, or the instructions.
 - ② Under the direct sunlight or outdoors.
 - ③ Excessive vibrations and impacts.
 - ④ Exposure / adhere to corrosive gas, inflammable gas, chemicals, seawater, water and vapor. *
 - * Some products can be used under the condition above(④), refer to the details of specification and condition of each product.
2. Do not disassemble or modify PISCO products, which affect the performance, function, and basic structure of the product.
3. Turn off the power supply, stop the air supply to PISCO products, and make sure there is no residual air pressure in the pipes before maintenance and inspection.
4. Do not touch the release-ring of push-in fitting when there is a working pressure. The lock may be released by the physical contact, and tube may fly out or slip out.
5. Frequent switchover of compressed air may generate heat, and there is a risk of causing burn injury.
6. Avoid any load on PISCO products, such as a tensile strength, twisting and bending. Otherwise, there is a risk of causing damage to the products.
7. As for applications where threads or tubes swing / rotate, use Rotary Joints, High Rotary Joints or Multi-Circuit Rotary Block only. The other PISCO products can be damaged in these applications.
8. Use only Die Temperature Control Fitting Series, Tube Fitting Stainless SUS316 Series, Tube Fitting Stainless SUS316 Compression Fitting Series or Tube Fitting Brass Series under the condition of over 60°C (140° F) water or thermal oil. Other PISCO products can be damaged by heat and hydrolysis under the condition above.
9. As for the condition required to dissipate static electricity or provide an antistatic performance, use EG series fitting and antistatic products only, and do not use other PISCO products. There is a risk that static electricity can cause system defects or failures.
10. Use only Fittings with a characteristic of spatter-proof such as Anti-spatter or Brass series in a place where flame and weld spatter is produced. There is a risk of causing fire by sparks.
11. Turn off the power supply to PISCO products, and make sure there is no residual air pressure in the pipes and equipment before maintenance. Follow the instructions below in order to ensure safety.
 - ① Make sure the safety of all systems related to PISCO products before maintenance.
 - ② Restart of operation after maintenance shall be proceeded with care after ensuring safety of the system by preventive measures against unexpected movements of machines and devices where pneumatic equipment is used.
 - ③ Keep enough space for maintenance when designing a circuit.
12. Take safety measures such as providing a protection cover if there is a risk of causing damages or fires on machine / facilities by a fluid leakage.

⚠ Caution

1. Remove dusts or drain before piping. They may get into the peripheral machine / facilities and cause malfunction.
2. When inserting an ultra-soft tube into push-in fitting, make sure to place an Insert Ring into the tube edge. There is a risk of causing the escape of tube and a fluid leakage without using an Insert Ring.
3. The product incorporating NBR as seal rubber material has a risk of malfunction caused by ozone crack. Ozone exists in high concentrations in static elimination air, clean-room, and near the high-voltage motors, etc. As a countermeasure, material change from NBR to HNBR or FKM is necessary. Consult with PISCO for more information.
4. Special option "Oil-free" products may cause a very small amount of a fluid leakage. When a fluid medium is liquid or the products are required to be used in harsh environments, contact us for further information.
5. In case of using non-PISCO brand tubes, make sure the tolerance of the outer tube diameter is within the limits of Table 1.

● Table 1. Tube O.D. Tolerance

mm size	Nylon tube	Polyurethane tube	inch size	Nylon tube	Polyurethane tube
ø1.8mm	—	± 0.05mm	ø1/8	± 0.1mm	± 0.15mm
ø3mm	—	± 0.15mm	ø5/32	± 0.1mm	± 0.15mm
ø4mm	± 0.1mm	± 0.15mm	ø3/16	± 0.1mm	± 0.15mm
ø6mm	± 0.1mm	± 0.15mm	ø1/4	± 0.1mm	± 0.15mm
ø8mm	± 0.1mm	± 0.15mm	ø5/16	± 0.1mm	± 0.15mm
ø10mm	± 0.1mm	± 0.15mm	ø3/8	± 0.1mm	± 0.15mm
ø12mm	± 0.1mm	± 0.15mm	ø1/2	± 0.1mm	± 0.15mm
ø16mm	± 0.1mm	± 0.15mm	ø5/8	± 0.1mm	± 0.15mm

6. Instructions for Tube Insertion

- ① Make sure that the cut end surface of the tube is at right angle without a scratch on the surface and deformations.
- ② When inserting a tube, the tube needs to be inserted fully into the push-in fitting until the tubing edge touches the tube end of the fitting as shown in the figure below. Otherwise, there is a risk of leakage.

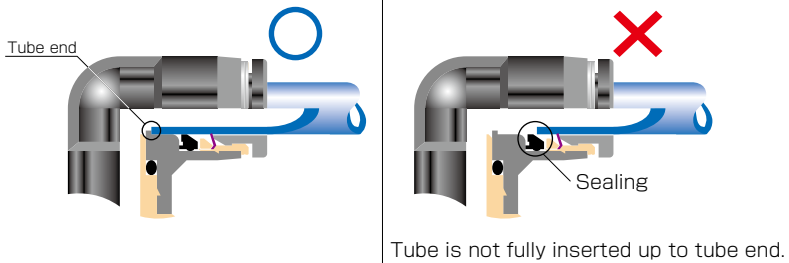

- ③ After inserting the tube, make sure it is inserted properly and not to be disconnected by pulling it moderately.
- ※ When inserting tubes, Lock-claws may be hardly visible in the hole, observed from the front face of the release-ring. But it does not mean the tube will surely escape. Major causes of the tube escape are the followings;
 - ① Shear drop of the lock-claws edge
 - ② The problem of tube diameter (usually small)
 Therefore, follow the above instructions from ① to ③, even lock-claws is hardly visible.

7. Instructions for Tube Disconnection

- ① Make sure there is no air pressure inside of the tube, before disconnecting it.
- ② Push the release-ring of the push-in fitting evenly and deeply enough to pull out the tube toward oneself. By insufficient pushing of the release-ring, the tube may not be pulled out or damaged by scratch, and tube shavings may remain inside of the fitting, which may cause the leakage later.

8. Instructions for Installing a fitting

- ① When installing a fitting, use proper tools to tighten a hexagonal-column or an inner hexagonal socket. When inserting a hex key into the inner hexagonal socket of the fitting, be careful so that the tool does not touch lock-claws. The deformation of lock-claws may result in a poor performance of systems or an escape of the tube.
- ② Refer to Table 2 which shows the recommended tightening torque. Do not exceed these limits to tighten a thread. Excessive tightening may break the thread part or deform the gasket and cause a fluid leakage. Tightening thread with tightening torque lower than these limits may cause a loosened thread or a fluid leakage.
- ③ Adjust the tube direction while tightening thread within these limits, since some PISCO products are not rotatable after the installation.

● Table 2: Recommended tightening torque / Sealock color / Gasket materials

Thread type	Thread size	Tightening torque	Sealock color	Gasket materials
Metric thread	M3 × 0.5	0.7N·m	—	SUS304 NBR
	M5 × 0.8	1.0 ~ 1.5N·m		
	M6 × 1	2 ~ 2.7N·m		
	M3 × 0.5	0.5 ~ 0.6N·m		POM
	M5 × 0.8	1 ~ 1.5N·m		
	M6 × 0.75	0.8 ~ 1N·m		
Taper pipe thread	M8 × 0.75	1 ~ 2N·m	White	—
	R1/8	7 ~ 9N·m		
	R1/4	12 ~ 14N·m		
	R3/8	22 ~ 24N·m		
Unified thread	R1/2	28 ~ 30N·m	—	SUS304, NBR
	No.10-32UNF	1.0 ~ 1.5N·m		
National pipe thread taper	1/16-27NPT	7 ~ 9N·m	White	—
	1/8-27NPT	7 ~ 9N·m		
	1/4-18NPT	12 ~ 14N·m		
	3/8-18NPT	22 ~ 24N·m		
	1/2-14NPT	28 ~ 30N·m		

※ These values may differ for some products. Refer to each specification as well.

9. Instructions for removing a fitting

- ① When removing a fitting, use proper tools to loosen a hexagonal-column or an inner hex bolt.
- ② Remove the sealant stuck on the mating equipment. The remained sealant may get into the peripheral equipment and cause malfunctions.

10. Arrange piping avoiding any load on fittings and tubes such as twist, tensile, moment load, shaking and physical impact. These may cause damages to fittings, tube deformations, bursting and the escape of tubes.



Common Safety Instructions for Valves

Before selecting or using PISCO products, read the following instructions. Read the detailed instructions for individual series as well as the instructions below.

Warning

1. Some products have an air direction to control. Make sure to distinguish the direction by the catalog or marking on the products. Installing the product with the wrong direction may cause personal injury or property damage.
2. Do not operate manual valves by machine. It may cause damage to the products.
3. Use clean air to supply and remove drainage and dusts. Place an air filter on the upstream side of valves. Impurities in the compressed air can cause malfunction of valves.
4. Avoid any load on PISCO products such as a tensile strength, twisting, bending, dropping and excessive impacts. These may cause damage to the products.

⚠ Caution

1. Refer to “Common Safety Instructions for Fittings” for the safety instructions for fitting part.
2. Instructions for Installing Valves
 - ① Use proper tools to tighten a hexagonal-column of Hand Valve and Ball Valve with taper pipe thread.
 - ② Refer to the following table which shows the recommended tightening torque to tighten thread. Excessive tightening may break the thread part or cause a fluid leakage due to the deformation of thread. Tightening thread with the tightening torque lower than these limits may cause a loosened thread or a fluid leakage.

● Table: Recommended tightening torque

Thread type	Thread size	Torque force
Taper pipe thread	R1/8	7 ~ 9Nm
	R1/4	12 ~ 14Nm
	R3/8	22 ~ 24Nm
	R1/2	28 ~ 30Nm

3. Instructions for removing Valve

- ① When removing taper pipe thread of Hand Valve and Ball Valve, use proper tools to loosen a hexagonal-column.
- ② Remove the sealant stuck on the mating equipment. The remained sealant may get into the peripheral equipment and cause malfunction.