

Type 8098 FLOWave L

SAW Flowmeter



Operating Instructions

Software version A.04.00.00 and higher

We reserve the right to make technical changes without notice.

© Bürkert SAS, 2015–2022

Operating Instructions 2203/08_EU-EN 00567647 / Original EN

GENERAL INFORMATION	5
DESCRIPTION	13
TECHNICAL DATA	21
INSTALLATION IN THE PIPE	37
ELECTRICAL INSTALLATION	51
COMMISSIONING	73
DOING THE SETTINGS	79
MENU DISPLAY	97
MENU GENERAL SETTINGS	105
MENU SAW SENSOR – PARAMETER	145
MENU SAW SENSOR – DIAGNOSTICS	249
MENU SAW SENSOR – MAINTENANCE	255
MENU OUTPUTS	287
MENU INDUSTRIAL COMMUNICATION	305
TROUBLESHOOTING, MAINTENANCE, TRANSPORT, STORAGE	317
APPENDIX	351

General information

1	THE OPERATING INSTRUCTIONS	6
1.1	Symbols used	6
1.2	Definition of the term device	6
1.3	Definition of the term büS.....	7
1.4	Validity of the Operating Instructions.....	7
2	INTENDED USE	8
2.1	Device with ATEX / IECEx certification	8
3	BASIC SAFETY INFORMATION	9
4	GENERAL INFORMATION.....	11
4.1	Manufacturer's address and international contacts	11
4.2	Warranty conditions.....	11
4.3	Information on the Internet.....	11

MAN 1000273158 EN Version: M Status: RL (released | freigegeben) printed: 22.06.2022

1 THE OPERATING INSTRUCTIONS

The Operating Instructions describe the entire life cycle of the device. Please keep the Operating Instructions in a safe place, accessible to all users and any new owners.

The Operating Instructions contain important safety information.

Failure to comply with these instructions can lead to hazardous situations. Pay attention in particular to the chapters [3 Basic safety information](#) and [2 Intended use](#).

► Irrespective of the device variant, the Operating Instructions must be read and understood.

1.1 Symbols used



DANGER

Warns against an imminent danger.

► Failure to observe this warning results in death or in serious injury.



WARNING

Warns against a potentially dangerous situation.

► Failure to observe this warning can result in serious injury or even death.



CAUTION

Warns against a possible risk.

► Failure to observe this warning can result in substantial or minor injuries.

NOTICE

Warns against material damage.



Indicates additional information, advice or important recommendations.



Refers to information contained in these Operating Instructions or in other documents.

► Indicates an instruction to be carried out to avoid a danger, a warning or a possible risk.

→ Indicates a work step which you must carry out.

A **highlighted term** is related to a menu or a menu item.

✓ Indicates the result of a specific instruction.

1.2 Definition of the term device

The term "device" used in these Operating Instructions always refers to the Type 8098 FLOWave L flowmeter.

1.3 Definition of the term büS









The term "büS" used in these Operating Instructions refers to the industrial communication, developed by Bürkert, based on the CANopen protocol. The term "büS" refers to the Bürkert system bus.

- For more information on büS, read the cabling guide available in English and in Japanese (Cabling_guide_for_büS/EDIP.pdf) at country.burkert.com.
- For more information on CANopen which is related to the device, refer to the Operating Instructions "CANopen Network configuration" at country.burkert.com.

1.4 Validity of the Operating Instructions

The Operating Instructions are valid for the devices from software version A.04.00.00.

To read out the version number of the device software, do the following:

- Go to the **CONFIGURATION** view.
-  **General settings**
-  Confirm to access the **Parameter** view.
-  Go to the **MAINTENANCE** view.
-  **Device information** -----> 
-  **Software version** -----> 
-  Go back to the parent menu.

2 INTENDED USE

Use of the device that does not comply with the instructions could present risks to people, nearby installations and the environment.

The Type 8098 FLOWave L flowmeter uses the Surface Acoustic Wave (SAW) measurement principle and is intended to measure the flow rate of liquids that have all the following characteristics:

- clean liquids
 - non emulsified liquids (homogeneous liquids)
 - liquids that are free of air bubbles
 - liquids that are free of gas bubbles
 - liquids that are free of solids.
- ▶ The device is not intended to measure the flow rate of liquids if gas bubbles are present, whatever the origin of the bubbles (air intake, cavitation, degassing...).
 - ▶ Use the device in compliance with the characteristics and the conditions of commissioning and use specified in the contractual documents and in the Operating Instructions.
 - ▶ Protect the device against electromagnetic interference, ultraviolet rays and, when installed outdoors, against the effects of climatic conditions.
 - ▶ Only operate a device in perfect working order.
 - ▶ Properly transport, store, install and operate the device.
 - ▶ Only use the device as intended.

2.1 Device with ATEX / IECEx certification



DANGER

Risk of explosion in the event of improper use of the device in potentially explosive areas.

- ▶ Observe the specifications of the ATEX / IECEx-conformity certificate.
- ▶ Observe the specifications given in the ATEX / IECEx supplement for Type 8098 FLOWave L. The supplement is available at country.burkert.com

The ATEX / IECEx certification is only valid if the device is used as described in the ATEX / IECEx supplement.

If unauthorized changes are made to the device, then the ATEX / IECEx certification becomes invalid.

3 BASIC SAFETY INFORMATION

This safety information does not take into account any contingencies or occurrences that may arise during installation, use and maintenance of the device.

The operating company is responsible for the respect of the local safety regulations, including staff safety.



Risk of injury due to electrical voltage.

- ▶ Before carrying out work on the system, disconnect the electrical power for all the conductors and isolate it.
- ▶ In accordance with standard UL/EN 61010-1, all equipment connected to the Type 8098 FLOWave L flowmeter shall be double insulated with respect to the mains and all circuits connected to the Type 8098 FLOWave L flowmeter must be limited energy circuits.
- ▶ Observe all applicable accident protection and safety regulations for electrical equipment.

Risk of injury due to pressure in the installation.

- ▶ Before any intervention in the installation, stop the circulation of liquid, cut off the pressure and drain the pipe.
- ▶ Before any intervention in the installation, make sure there is no pressure in the pipe.
- ▶ Observe the dependency between the liquid temperature and the liquid pressure for the fitting used.

If switched on for a prolonged time, risk of burns or fire due to hot device surfaces

- ▶ Do not touch with bare hands.
- ▶ Keep the device away from highly flammable substances and liquids.

Risk of burns due to high liquid temperatures.

- ▶ Do not touch with bare hands the parts of the device that are in contact with the liquid.
- ▶ Use safety gloves to handle the device.
- ▶ Before opening the pipe, stop the circulation of liquid and drain the pipe.
- ▶ Before opening the pipe, make sure the pipe is completely empty.

Risk of injury due to the nature of the liquid.

- ▶ Respect the prevailing regulations on accident prevention and safety relating to the use of dangerous liquids.



General dangerous situations

To avoid injury, obey the following instructions:

- ▶ Do not use the device in explosive atmospheres ¹⁾.
- ▶ Do not use the device in an environment incompatible with the device materials.
- ▶ Do not use liquid that is incompatible with the device materials. Find the compatibility chart on our homepage: country.burkert.com
- ▶ Do not subject the device to mechanical loads.
- ▶ Do not make any modifications to the device.
- ▶ Prevent any unintentional power supply switch-on.
- ▶ Only qualified and skilled staff may carry out installation and maintenance work.
- ▶ Ensure a defined or controlled restarting of the process after a power supply interruption.
- ▶ Observe the general technical rules.

¹⁾ only applicable for devices without ATEX / IECEx certification



CAUTION

Risk of injury due to a heavy device.

A heavy device can fall down during transport or during installation and cause injuries.

- ▶ Transport, install and dismantle a heavy device with the help of another person.
- ▶ Use appropriate tools.

NOTICE

Elements and components sensitive to electrostatic discharges

- ▶ This device contains electronic components that are sensitive to electrostatic discharges. They may be damaged if they are touched by an electrostatically charged person or object. In the worst case scenario, these components are instantly destroyed or disabled as soon as they are activated.
- ▶ To minimise or even avoid any damage caused by an electrostatic discharge, take all the precautions described in standard EN 61340-5-1.
- ▶ Also make sure that you do not touch any of the live electrical components.

4 GENERAL INFORMATION

4.1 Manufacturer's address and international contacts

To contact the manufacturer of the device, use the following address:

Bürkert SAS

Rue du Giessen

BP 21

F-67220 TRIEMBACH-AU-VAL

You may also contact your local Bürkert sales office.

The addresses of our international sales offices are available on the internet at: country.burkert.com

4.2 Warranty conditions

The condition governing the legal warranty is the conforming use of the device in observance of the operating conditions specified in the Operating Instructions.

4.3 Information on the Internet

You can find the operating instructions and the technical data sheets for Type 8098 FLOWave L at: country.burkert.com

Description

5	DESCRIPTION	14
5.1	Device variants.....	14
5.2	Wi-Fi module	16
5.3	Unlocking magnetic key	16
5.4	Type labels	17
5.4.1	Adhesive labels.....	17
5.4.2	Laser marking	19
5.5	Marking with the MAC address.....	19
5.6	Certification markings.....	19
5.7	Marking of the Unique Serial Number (USN)	19
5.8	Device status indicator	20

MAN 1000273158 EN Version: M Status: RL (released | freigegeben) printed: 22.06.2022

5 DESCRIPTION

5.1 Device variants

The Type 8098 FLOWave L flowmeter is made up of a Type SE98 transmitter and a Type S097 flow sensor. The following pictures describe the main device variants of the Type 8098 FLOWave L flowmeter:

- Fig. 1 describes a device with two M20x1.5 cable glands in stainless steel (or in nickel plated brass) and one 5-pin M12 male connector.
- Fig. 2 describes the Ethernet device variant, i.e. a device with two 4-pin M12 female connectors and one 5-pin M12 male connector.

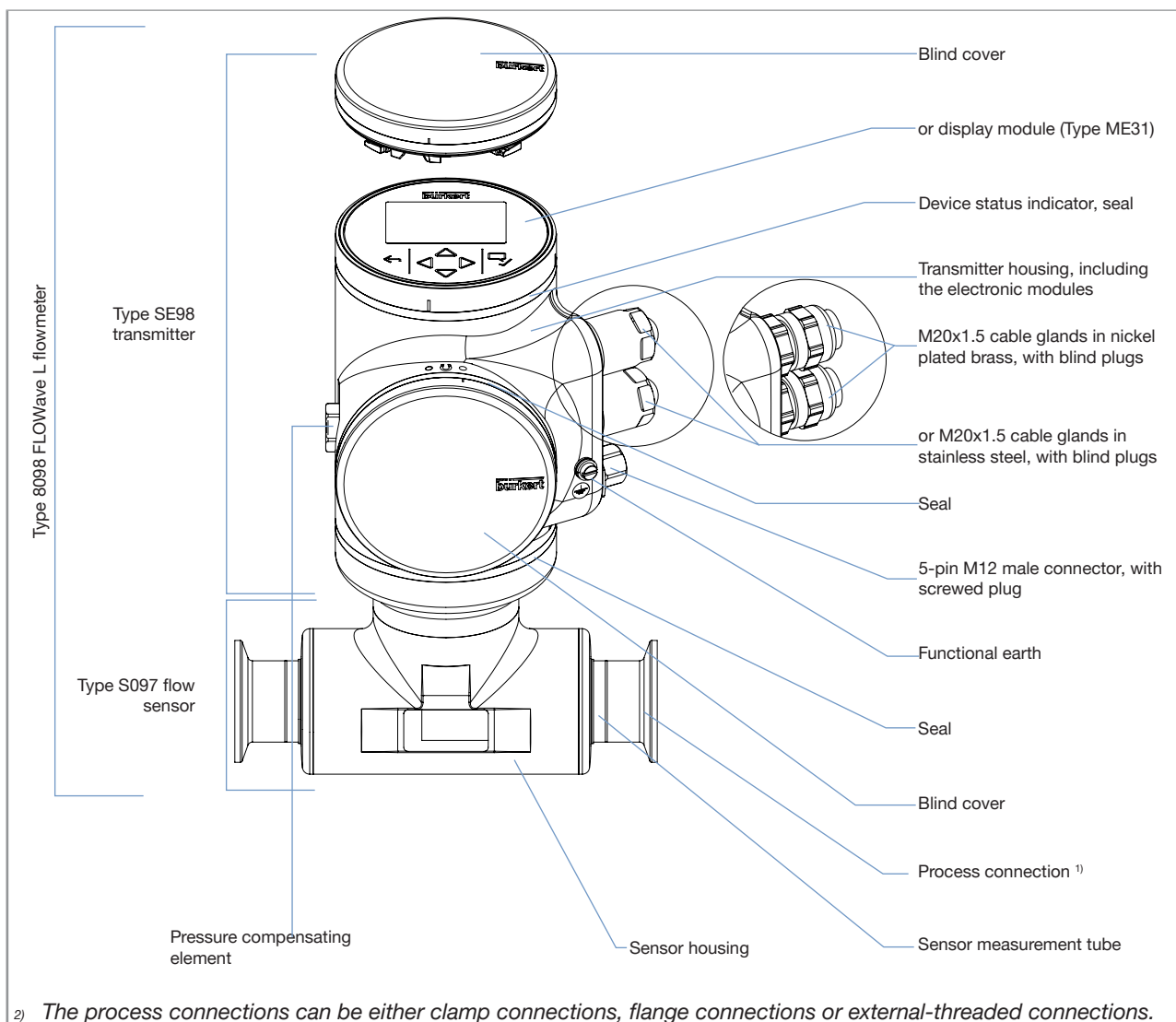

Fig. 1: Description of the device variants with two M20x1.5 cable glands and one 5-pin M12 male connector

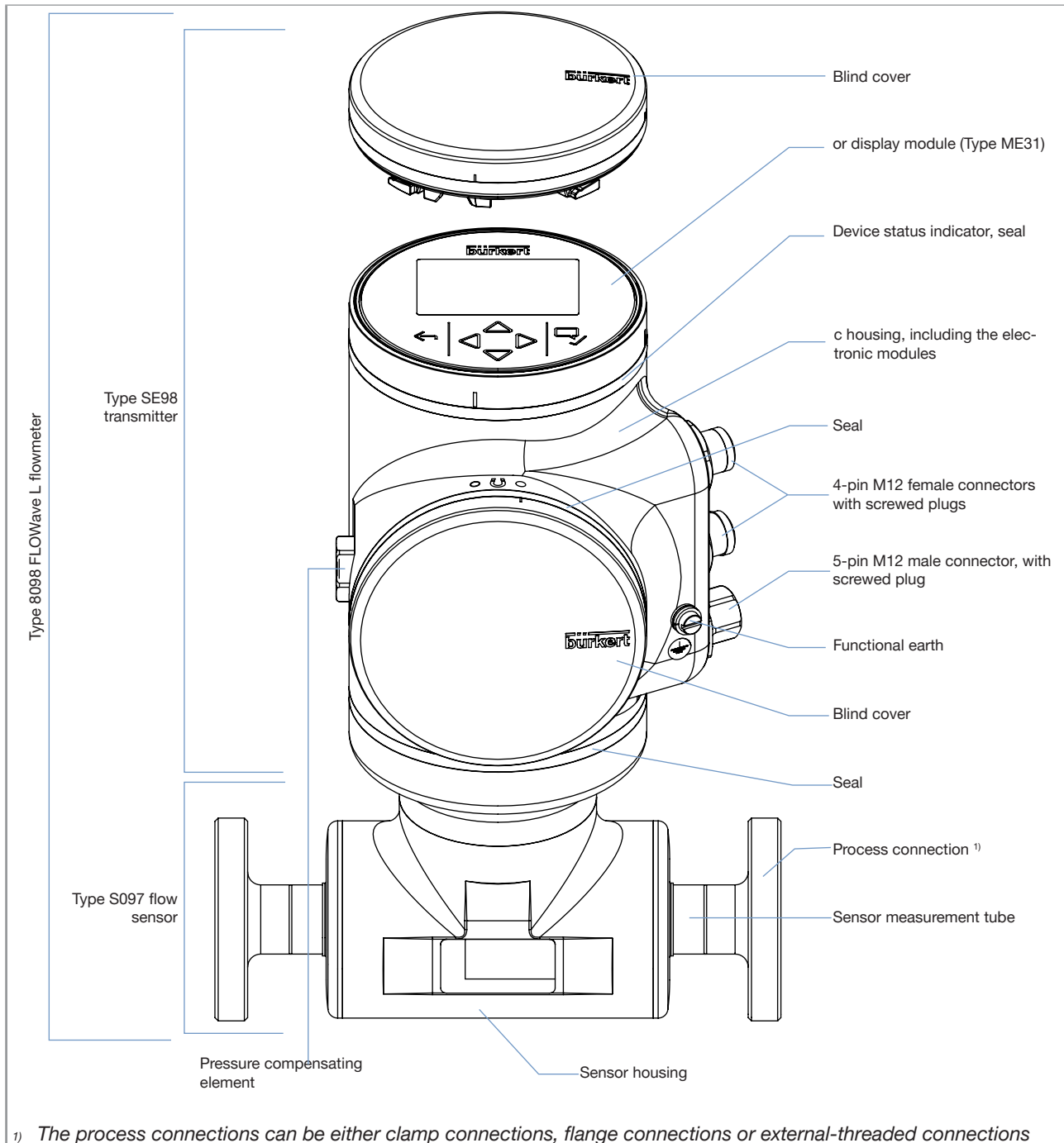

Fig. 2: Description of an Ethernet device variant, with two 4-pin M12 female connectors and one 5-pin M12 male connector

5.2 Wi-Fi module

The device can be equipped with a Wi-Fi module in place of or in addition to the display module. The Wi-Fi module has the Type number ME31. The Wi-Fi module has the same functional scope as the display module.

The Wi-Fi module is intended for use in Europe, the USA, and Canada.

The module can be integrated into an existing WLAN infrastructure. The wireless range is approximately 10 m.

The module provides a web server which can be accessed if the following requirements are met:

- Windows 7/8.1/10: IE11, Edge, Google Chrome, from version 53.
- Android with Google: Chrome, from version 53.
- Apple: Safari, from iOS 9.3.5.

→ For more informations about the Wi-Fi module, refer to the Software manual ME31 | WLAN module, available at country.burkert.com.

5.3 Unlocking magnetic key

The device is delivered with a magnetic key to unlock the display module, the Wi-Fi module or the blind cover. See [Fig. 3](#).



Fig. 3: *Unlocking magnetic key*

The device operates on a 4-wire system and needs a 12...35 V DC power supply.

The device has three outputs:

- 1 analogue output,
- 1 digital output,
- 1 output, which can be configured as an analogue output or as a digital output.

5.4 Type labels

5.4.1 Adhesive labels

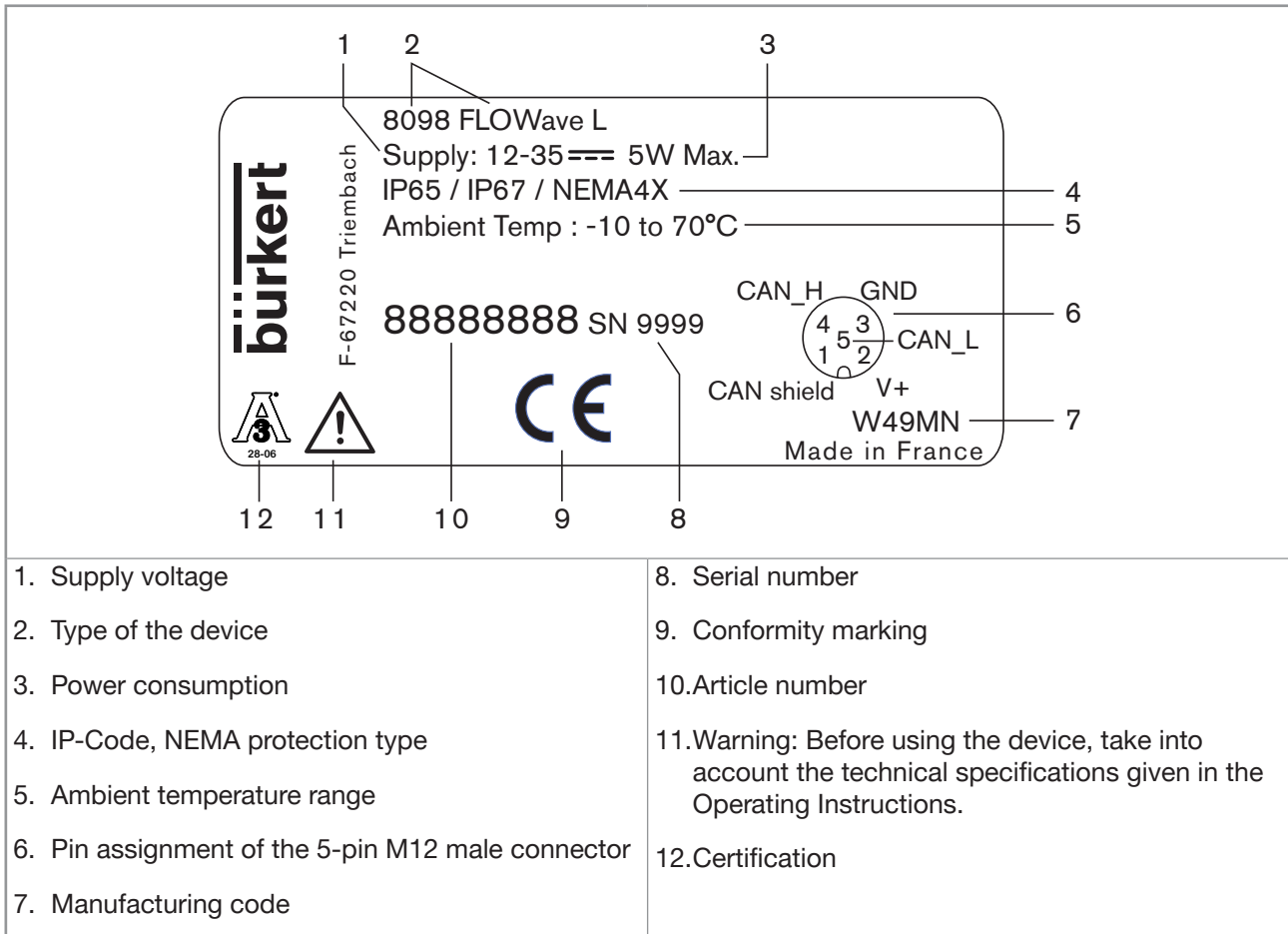

Fig. 4: Type label, Type 8098 FLOWave L flowmeter (example of a UL device)

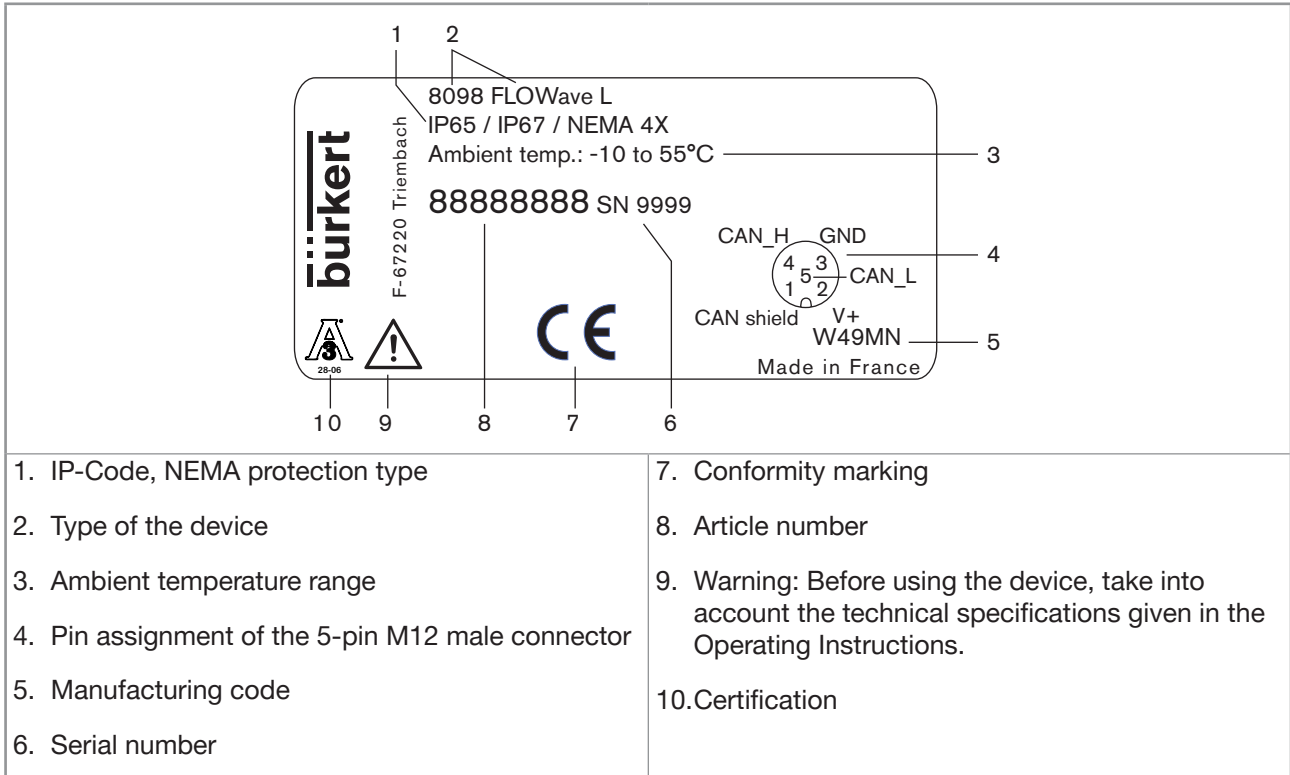

Fig. 5: Type label, Type 8098 FLOWave L flowmeter (example of a non-UL Ethernet device)

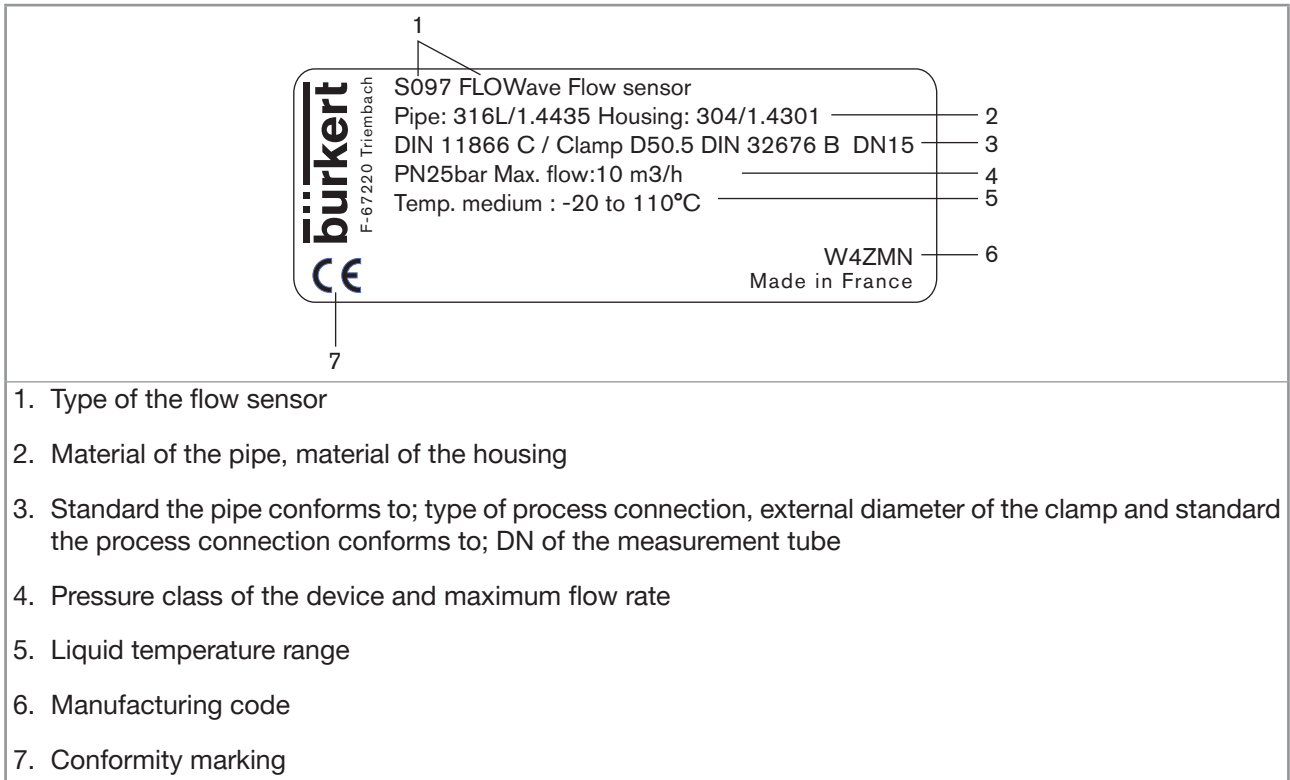

Fig. 6: Type label, Type S097 flow sensor (example)

5.4.2 Laser marking

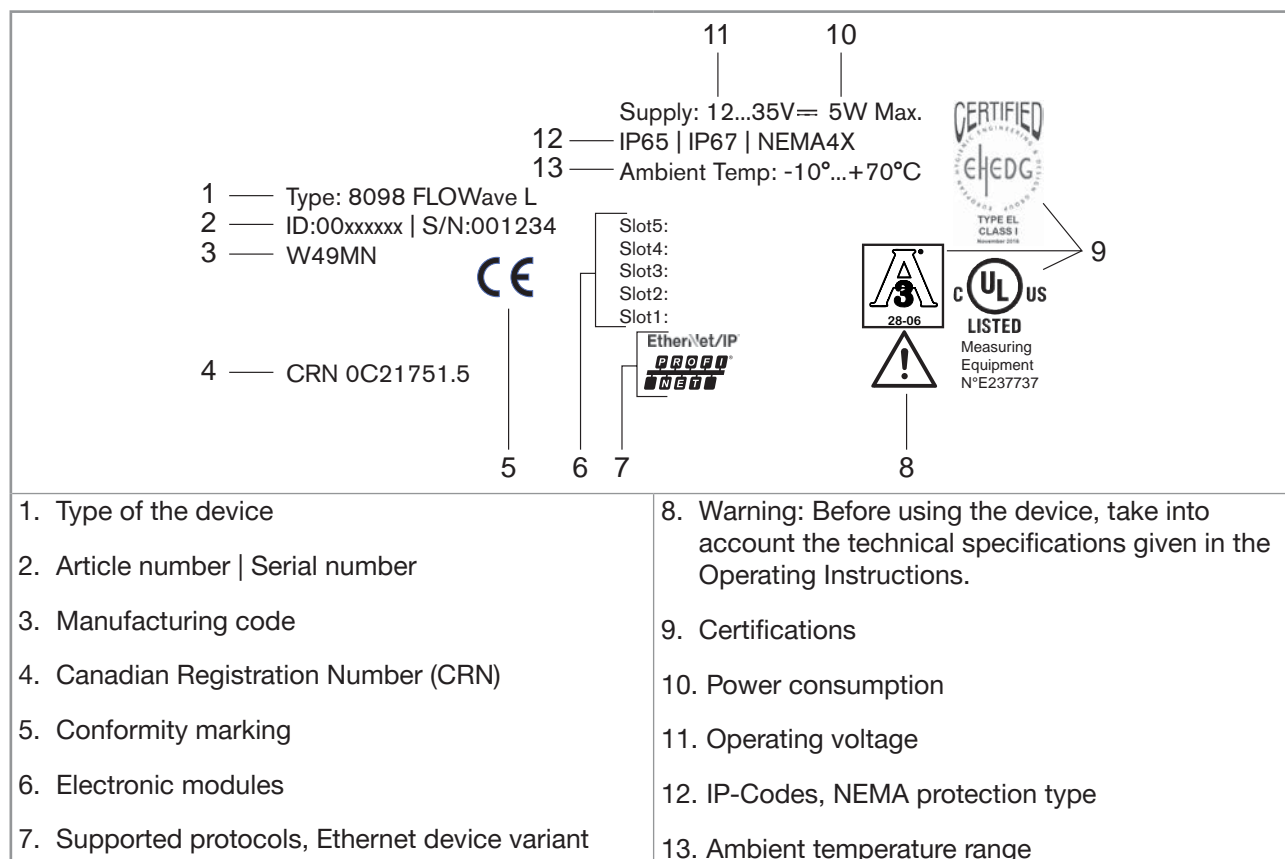

Fig. 7: Laser marking, Type 8098 FLOWave L flowmeter (example of a UL Ethernet device)

5.5 Marking with the MAC address

The marking with the MAC address can be seen by opening the front of the transmitter.

→ To open the front of the transmitter, see chapter 8.9 on page 59.



Fig. 8: Marking with the MAC address of the device (example)

5.6 Certification markings

Certification markings are either located on the Type label of the measuring device or on separate labels.

5.7 Marking of the Unique Serial Number (USN)

The USN is marked on the side of the sensor. The USN is built with the device article number and the device serial number.

5.8 Device status indicator

The device status indicator changes its colour based on the NAMUR NE 107 recommendation.

The color of the device status indicator gives the following pieces of information:

- Whether device diagnostics are active or not.
- If device diagnostics are active, then the device status indicator shows whether diagnostics events have been generated or not. If several diagnostics events have been generated, then the device status indicator shows the diagnostics event with the highest priority. Refer to [Table 1](#).

If the device status indicator flashes, then the device is selected in a man-machine interface such as the Bürkert Communicator software.

Table 1: Device status indicator in accordance with NAMUR NE 107, edition 2006-06-12

Colour according to NE 107	Colour code (for a PLC)	Diagnostics event according to NE 107	Meaning
Red	5	Failure, error or fault	Due to a malfunction of the device or its periphery, the measured values can be incorrect.
Orange	4	Check function	Ongoing work on the device (for example, checking the correct behaviour of the outputs by simulating measurement values); the output signal is temporarily invalid (e.g. frozen).
Yellow	3	Out of specification	The ambient conditions or process conditions for the device are outside the permitted ranges. Device-internal diagnostics point to problems in the device or with the process properties.
Blue	2	Maintenance required	The device continues to measure but a function is temporarily restricted. → Do the required maintenance operation.
Green	1	-	Diagnostics are active and no diagnostics event has been generated.
White	0	-	Diagnostics are inactive.

Technical data

6	TECHNICAL DATA	22
6.1	Operating conditions	22
6.2	Conformity to standards and directives	23
6.2.1	Conformity to the Pressure Equipment Directive.....	23
6.2.2	UL certification.....	23
6.2.3	EHEDG certification.....	24
6.2.4	ATEX / IECEx certification	24
6.3	Liquid data	25
6.4	Measurement data	27
6.4.1	Volume flow rate	27
6.4.2	Temperature	27
6.4.3	Differentiation factor.....	28
6.4.4	Acoustic transmission factor	28
6.4.5	Density	28
6.4.6	Mass flow rate.....	28
6.5	Electrical data	29
6.6	Mechanical data.....	31
6.7	Specifications of the Ethernet Industrial communication	32
6.7.1	Modbus TCP protocol	32
6.7.2	PROFINET protocol	33
6.7.3	EtherNet/IP protocol.....	34
6.7.4	EtherCAT protocol.....	35

6 TECHNICAL DATA

6.1 Operating conditions

Ambient temperature	Depends on the liquid temperature (see Fig. 9 or Fig. 10)
<ul style="list-style-type: none"> • Device variant with two M20x1.5 cable glands and one 5-pin M12 connector 	<ul style="list-style-type: none"> • -10 °C...+70 °C, if the liquid temperature is -10 °C...+80 °C (see Fig. 9) • See Fig. 9, if the liquid temperature is higher than +80 °C
<ul style="list-style-type: none"> • Device variant with two 4-pin M12 female connectors and one 5-pin M12 connector (Ethernet device variant) 	<ul style="list-style-type: none"> • -10 °C...+55 °C (see Fig. 10)
Air humidity	< 85 %, non condensing
Height above sea level	max. 2000 m
Operating conditions	Continuous operation
Equipment mobility	Fixed device
Use	Indoor and outdoor <ul style="list-style-type: none"> ▶ Protect the device against electromagnetic interference, ultraviolet rays and, when installed outdoors, against the effects of climatic conditions.
Installation category	Category I according to UL/EN 61010-1
Degree of pollution	Degree 2 according to UL/EN 61010-1
Protection class according to IEC/EN 60529	IP65 ¹⁾ , IP67 ¹⁾ if the following conditions are observed: <ul style="list-style-type: none"> • The device must be wired. • The cable glands must be tightened. • The covers must be screwed tight. • Unused cable glands must be sealed with the blind plugs provided. The blind plugs are mounted upon delivery of the device. • Unused M12 connectors must be protected by a screwed plug.
Protection class according to NEMA250¹⁾	4X if the following conditions are observed: <ul style="list-style-type: none"> • The device must be wired. • The cable glands must be tightened. • The covers must be screwed tight. • Unused cable glands must be sealed with the blind plugs provided. The blind plugs are mounted upon delivery of the device. • Unused M12 connectors must be protected by a screwed plug.

¹⁾ not evaluated by UL; only IP64 is evaluated by the ATEX / IECEx notified/certification body

→ For the special operating conditions of devices with ATEX / IECEx certification, refer to the ATEX / IECEx supplement for the device. The supplement is available at country.burkert.com.

6.2 Conformity to standards and directives

The applied standards, which verify conformity with the EU Directives, can be found on the EU Type Examination Certificate and/or the EU Declaration of Conformity (if applicable).

6.2.1 Conformity to the Pressure Equipment Directive

- ▶ Make sure that the device materials are compatible with the liquid.
- ▶ Make sure that the pipe DN is adapted for the device.
- ▶ Observe the liquid nominal pressure (PN) for the device. The nominal pressure (PN) is given by the device manufacturer.

The device conforms to Article 4, Paragraph 1 of the Pressure Equipment Directive 2014/68/EU under the following conditions:



- Device used on a pipe (PS = maximum admissible pressure, in bar; DN = nominal dimension of the pipe, no unit)

Type of liquid	Conditions
Fluid group 1, Article 4, Paragraph 1.c.i	DN ≤ 25
Fluid group 2, Article 4, Paragraph 1.c.i	DN ≤ 32 or PSxDN ≤ 1000 bar
Fluid group 1, Article 4, Paragraph 1.c.ii	DN ≤ 25 or PSxDN ≤ 2000 bar
Fluid group 2, Article 4, Paragraph 1.c.ii	DN ≤ 200 or PS ≤ 10 bar or PSxDN ≤ 5000 bar

6.2.2 UL certification

The devices with variable key PU01 or PU02 are UL-certified devices and comply also with the following standards:

- UL 61010-1
- CAN/CSA-C22.2 n°61010-1

Identification on the device	Certification	Variable key
	UL recognized	PU01
 Measuring Equipment E237737	UL listed	PU02

6.2.3 EHEDG certification

- EL class I
- The following device variants are EHEDG certified:

Process connections	Diameters
• Clamp ¹⁾ connections according to ASME BPE (DIN 32676 series C)	• 3/8", 1/2", 3/4", 1", 1 1/2", 2", 2 1/2", 3"
• Clamp connections according to DIN 11864-3 series C	• 1/2", 3/4", 1", 1 1/2", 2"
• Flange connections according to DIN 11864-2 series C	• 1/2", 3/4", 1", 1 1/2", 2"
• Clamp ¹⁾ connections according to DIN 32676 series B	• DN08, DN15 (except device variants with a clamp diameter of 34.0 mm), DN25, DN40, DN50, DN65, DN80
• Clamp ¹⁾ connections according to DIN 32676 series A	• DN08, DN15, DN25, DN40, DN50, DN65, DN80
• Clamp connections according to DIN 11864-3 series A, DIN 11864-3 series B	• DN08, DN15, DN25, DN40, DN50
• Clamp ¹⁾ connections according to SMS 3017 / ISO 2852 for pipes according to SMS 3008	• DN25, DN40, DN50
• Flange connections according to DIN 11864-2 series A, DIN 11864-2 series B	• DN08, DN15, DN25, DN40, DN50
• External-threaded ²⁾ connections according to DIN 11851 series A	• DN65, DN80

¹⁾ The EHEDG compliance is only valid if the connections are used in combination with EHEDG-compliant gaskets from Combifit International B.V.

²⁾ The EHEDG compliance is only valid if the connections are used in combination with EHEDG-compliant gaskets:

- ASEPTO-STAR k-flex upgrade gaskets from Kieselmann GmbH, Germany
- SKS gaskets set DIN 11851 EHEDG with EPDM or FKM inner gasket from Siersema Componenten Service (S.K.S.) B.V., Netherlands

→ To make sure you use EHEDG-compliant gaskets, refer to the "EHEDG Position Paper" available on the EHEDG website.



The manufacturer of the device does not supply any gaskets for the process connections.

6.2.4 ATEX / IECEx certification



→ Refer to the ATEX / IECEx supplement for the device. The supplement is available at country.burkert.com.

6.3 Liquid data

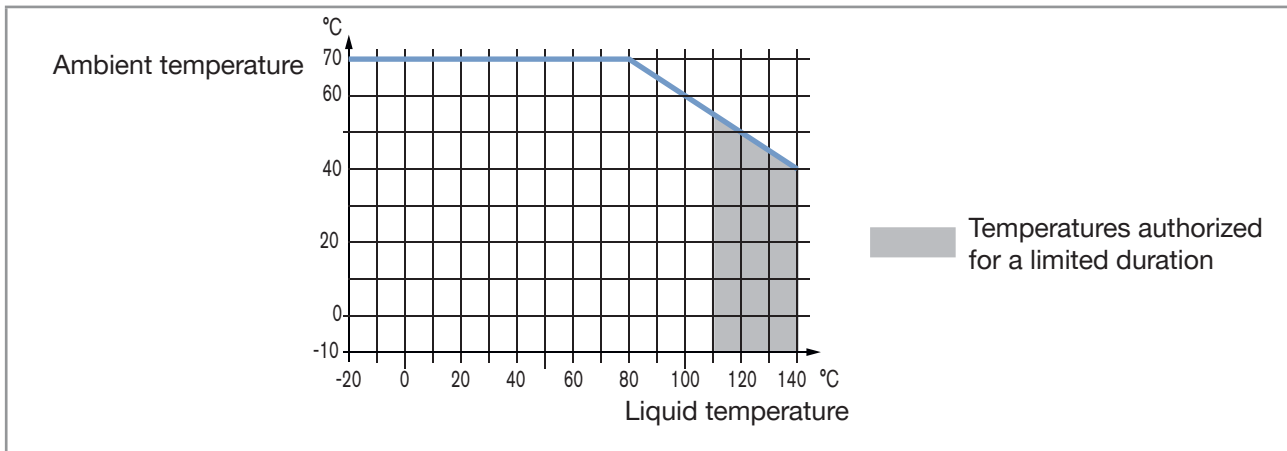

Fig. 9: Dependency between the liquid temperature and the ambient temperature, device variant with two M20x1.5 cable glands and one 5-pin M12 male connector

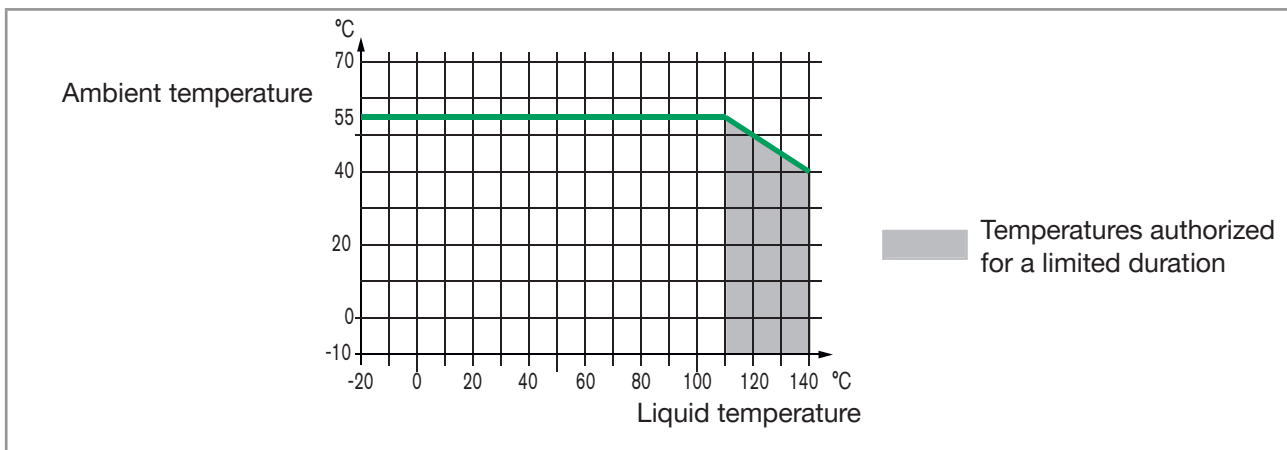

Fig. 10: Dependency between the liquid temperature and the ambient temperature, device variant with two 4-pin M12 female connectors and one 5-pin M12 male connector (Ethernet device variant)

Liquid temperature	-20 °C...+110 °C. Up to 140 °C for maximum 60 minutes for a sterilisation process. Maximum temperature gradient: 10 °C/s [measured by the sensor integrated in the device] The maximum liquid temperature can be restricted by the ambient operating temperature. Depending on the device variant, see Fig. 9 or Fig. 10
Type of liquids	Non-dangerous liquids according to Article 4, Paragraph 1 of Directive 2014/68/EU
Speed of sound in the liquid	
• DN08	• 1000...2000 m/s
• 3/8", 1/2"	
• from DN15 and above	• 800...2300 m/s
• from 3/4" and above	

Table 2: Liquid pressure, depending on the pipe diameter, the type of process connections and the process connection standard

Size of the process connection	Type of process connection	Standards the process connections conform to	PN
DN08, DN15, DN25	clamp	<ul style="list-style-type: none"> • DIN 11864-3 series B • DIN 32676 series A • DIN 32676 series B 	PN25
	flange	DIN 11864-2 series B	PN25
DN15, DN25	clamp	DIN 11864-3 series A	PN25
	flange	DIN 11864-2 series A	PN25
DN25	clamp	SMS 3017 / ISO 2852 for pipes according to SMS 3008	PN25
3/8", 1/2", 3/4", 1", 1 1/2"	clamp	ASME BPE (DIN 32676 series C)	PN25
1/2", 3/4", 1", 1 1/2"	clamp	DIN 11864-3 series C	PN25
	flange	DIN 11864-2 series C	PN25
DN40	clamp	<ul style="list-style-type: none"> • DIN 11864-3 series B • DIN 32676 series B • DIN 11864-3 series A 	PN16
		<ul style="list-style-type: none"> • DIN 32676 series A • SMS 3017 / ISO 2852 for pipes according to SMS 3008 	PN25
	flange	DIN 11864-2 series B	PN16
		DIN 11864-2 series A	PN25
DN50	clamp	<ul style="list-style-type: none"> • DIN 11864-3 series A • DIN 11864-3 series B • DIN 32676 series A • DIN 32676 series B • SMS 3017 / ISO 2852 for pipes according to SMS 3008 	PN16
	flange	<ul style="list-style-type: none"> • DIN 11864-2 series A • DIN 11864-2 series B 	PN16
2"	clamp	<ul style="list-style-type: none"> • ASME BPE (DIN 32676 series C) • DIN 11864-3 series C 	PN16
	flange	DIN 11864-2 series C	PN16

Size of the process connection	Type of process connection	Standards the process connections conform to	PN
DN65, DN80	clamp	<ul style="list-style-type: none"> • DIN 32676 series A • DIN 32676 series B 	PN10
	external threaded	<ul style="list-style-type: none"> • DIN 11851 	PN10
ASME 2 1/2", 3"	clamp	<ul style="list-style-type: none"> • DIN 32676 series C 	PN10

6.4 Measurement data

6.4.1 Volume flow rate

Table 3: Volume flow rate measurement

• Measurement range	• 0...1.7 m ³ /h to 0...200 m ³ /h, depending on the DN of the sensor
• Measurement deviation ^{1) 2)} for a volume flow rate between 10 % of the full scale and the full scale	• ±0.4 % of the measured value
• Measurement deviation ^{1) 2)} for a volume flow rate between 1 % of the full scale and 10 % of the full scale	• < ±0.08 % of the full scale
• Repeatability ²⁾ for a volume flow rate between 10 % of the full scale and the full scale	• ±0.2 % of the measured value
• Repeatability ²⁾ for a volume flow rate between 1 % of the full scale and 10 % of the full scale	• ±0.04 % of the full scale
• Refresh time	• Adjustable, see chapter 15.16 Setting the refresh time .

¹⁾ "Measurement bias" as defined in standard JCGM 200:2012.

²⁾ Determined under the following reference conditions: liquid = water, free of gas bubbles and solids; water and ambient temperatures = 23 °C ±1 °C (73.4 °F ±1.8 °F), device settings with their default values, short refresh time, while maintaining turbulent or laminar flow, applying the minimum inlet (40xDN) and minimum outlet (1xDN) straight pipe lengths, appropriate pipe dimensions.

6.4.2 Temperature

Table 4: Temperature measurement

• Measurement range	• -20 °C...+140 °C
• Measurement deviation ¹⁾ for temperatures up to 100 °C	• ±1 °C
• Measurement deviation ¹⁾ for temperatures in 100...140 °C	• ±1.5 %
• Refresh time	• 1 s

¹⁾ "Measurement bias" as defined in standard JCGM 200:2012.

6.4.3 Differentiation factor

Table 5: DF measurement (optional feature)

• Measurement range	• 0.8...1.3
• Resolution	• 0.00001
• Repeatability	• ± 0.5 % of the measured value
• Refresh time	• Adjustable, see chapter 15.16 Setting the refresh time .

6.4.4 Acoustic transmission factor

Table 6: Acoustic transmission factor measurement (optional feature)

• Measurement range	• 10 %...120 %
• Resolution	• 0.01 %
• Repeatability	• ± 2 % of the measured value
• Refresh time	• Adjustable, see chapter 15.16 Setting the refresh time .

6.4.5 Density

Table 7: Density measurement (optional feature)

• Measurement range	• 0.78...1.3 g/cm ³
• Measurement deviation	• ± 2 % of the measured value ¹⁾
• Repeatability	• ± 1 % of the measured value ¹⁾
• Refresh time	• Adjustable, see chapter 15.16 Setting the refresh time .

¹⁾ Determined under the following reference conditions: liquid free of gas bubbles and solids; medium and ambient temperatures = 23 °C \pm 1 °C (73.4 °F \pm 1.8 °F), device settings with their default values, refresh time short.

6.4.6 Mass flow rate

Table 8: Mass flow rate measurement (optional feature)

• Measurement range	• 0...1360 kg/h to 0...260000 kg/h, depending on the DN of the sensor
• Measurement deviation ^{1) 2)} for a mass flow rate between 10 % of the full scale and the full scale of volume flow rate	• ± 2.4 % of the measured value
• Measurement deviation ^{1) 2)} for a mass flow rate between 10 % of the full scale and the full scale of volume flow rate	• ± 2.08 % of the full scale
• Repeatability ²⁾ for a mass flow rate between 10 % of the full scale and the full scale	• ± 1.2 % of the measured value
• Repeatability ²⁾ for a mass flow rate between 1 % of the full scale and 10 % of the full scale	• ± 1.04 % of the full scale
• Refresh time	• Adjustable, see chapter 15.16 Setting the refresh time .

¹⁾ "Measurement bias" as defined in standard JCGM 200:2012.

²⁾ Determined under the following reference conditions: liquid = water, free of gas bubbles and solids; water and ambient temperatures = 23 °C \pm 1 °C (73.4 °F \pm 1.8 °F), device settings with their default values, short refresh time, while maintaining turbulent or laminar flow, applying the minimum inlet (40xDN) and minimum outlet (1xDN) straight pipe lengths, appropriate pipe dimensions.

6.5 Electrical data

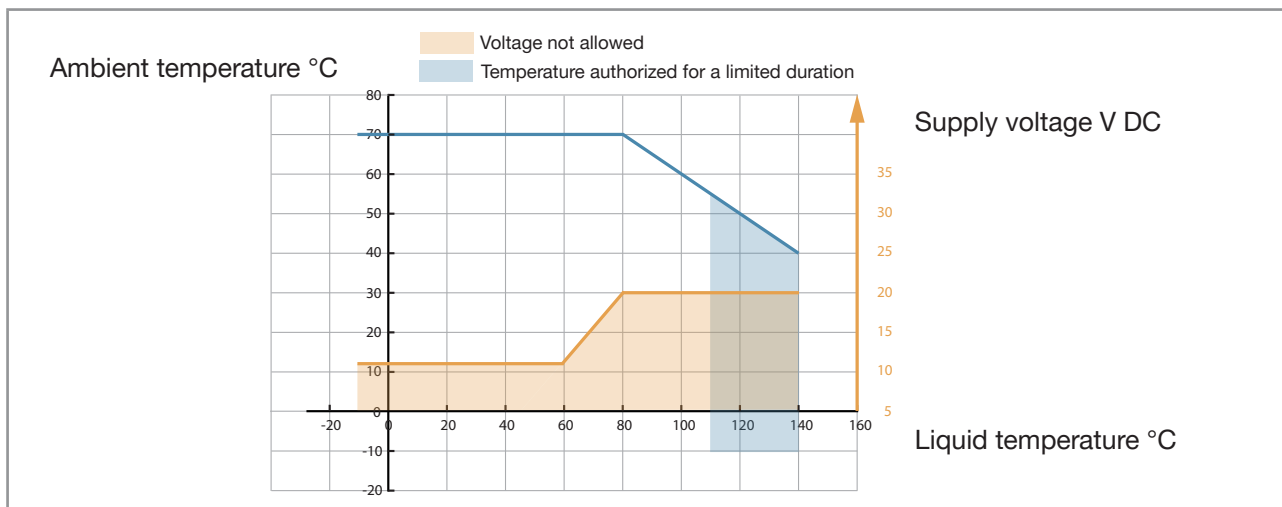

Fig. 11: Minimum supply voltage depending on the ambient temperature and the liquid temperature, device variant with two M20x1.5 cable glands and one 5-pin M12 male connector

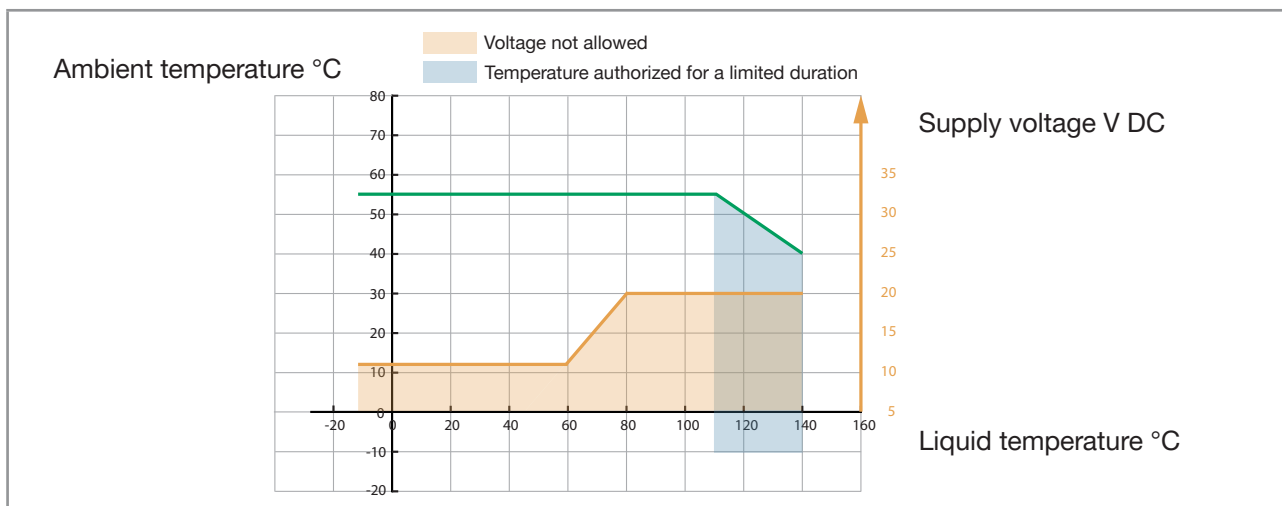

Fig. 12: Minimum supply voltage depending on the ambient temperature and the liquid temperature, device variant with two 4-pin M12 female connectors and one 5-pin M12 male connector (Ethernet device variant)

Operating voltage	<ul style="list-style-type: none"> • 12...35 V DC; the minimum voltage to be supplied depends on the liquid temperature and on the ambient operating temperature: depending on the device variant, see Fig. 11 or Fig. 12 • Current consumption: max. 2 A • Filtered and regulated • Tolerance: $\pm 10\%$ • The device must be connected permanently to a Safety Extra-Low Voltage circuit (SELV circuit). • Energize the device through a Limited Power Source (LPS) according to standards UL/EN 60950-1 or through a limited-energy circuit according to standards UL/EN 61010-1
Power consumption (without the consumption of the outputs)	
<ul style="list-style-type: none"> • Device variant with two M20x1.5 cable glands and one 5-pin M12 connector 	<ul style="list-style-type: none"> • $\leq 5\text{ W}$
<ul style="list-style-type: none"> • Device variant with two 4-pin M12 female connectors and one 5-pin M12 connector (Ethernet device variant) 	<ul style="list-style-type: none"> • $\leq 8\text{ W}$
Polarity reversal	Protected
Analogue output 1, also output 3 if configured as an analogue output	<ul style="list-style-type: none"> • 4...20 mA current; 3.6 mA or 22 mA to indicate an error • Uncertainty: $\pm 0.04\text{ mA}$ • Resolution: $0.8\ \mu\text{A}$ • Open loop detection through diagnostics software function • Any connection mode, in sink or source mode • Galvanically isolated, passive • Protected against polarity reversal • Maximum loop impedance 1300 Ω at 35 V DC, 1000 Ω at 30 V DC, 700 Ω at 24 V DC, 450 Ω at 18 V DC
Digital output 2, also output 3 if configured as a digital output	<ul style="list-style-type: none"> • Transistor • Any connection mode, in NPN or PNP mode • Pulse (by default), can be changed by the user • 0...2000 Hz • 5...35 V DC, max. 700 mA • Galvanically isolated, passive • Overload information through diagnostics software function • Protected against overloads • Protected against polarity reversals

6.6 Mechanical data

Dimensions and weight of the device: refer to the technical data sheet regarding Type 8098 FLOWave L available at country.burkert.com

Table 9: *Materials in contact with ambient air*

Component	Material
Transmitter housing ¹⁾	Stainless steel 304 / 1.4301, outer surface finish Ra < 1.6 µm
Sensor housing (depending on your device variant)	Stainless steel 304 / 1.4301, outer surface finish Ra < 1.6 µm
	Stainless steel 316L / 1.4435, outer surface finish Ra < 1.6 µm
Cable glands / Blind plugs / Sealing (depending on your device variant)	Stainless steel / PA6 / TPE
	Nickel plated brass / Black polyoxymethylene (POM) / HNBR and TPE
5-pin M12 male connector / Screwed plug / Sealing (depending on the device variant)	Stainless steel / Stainless steel / NBR
	Nickel plated brass / Nickel plated brass / NBR
4-pin M12 female connector / Screwed plug / Sealing	Stainless steel / Stainless steel / EPDM
Pressure compensating element	Stainless steel
External M4 screw for earth connection	Stainless steel A4
Display	Float glass, stainless steel 304 / 1.4301
Seals	VMQ silicone
Adhesive labels	Polyester

¹⁾ The housing may have slight machining marks due to the manufacturing process. These marks do not affect the operation of the device and are not a manufacturing defect.

Table 10: *Materials in contact with the liquid*

Component	Material
<ul style="list-style-type: none"> • Sensor measurement tube • Pipe connections 	Stainless steel 316L / DIN 1.4435 with low delta-ferrite rate

Table 11: *Available surface finish*

Component	Surface finish according to ISO 4288
Measurement tube (inner surface)	<ul style="list-style-type: none"> • Ra < 0.8 µm (30 µin) • Ra < 0.4 µm (15 µin) (electro-polished)
<ul style="list-style-type: none"> • Measurement tube (outer surface) • Housing 	Ra < 1.6 µm (excluding welding seams)

6.7 Specifications of the Ethernet Industrial communication

Table 12: Specifications of the industrial communication module

Network speed	10/100 mbps
Auto negotiation	Yes
Auto MDI/MDI-X	Yes
Switch function	Yes
Network diagnostics	Yes, via error telegram
MAC-ID	Individual identification number, stored in the module and on the outside of the device (see Type label)
Device name Ethernet (factory setting)	FLOWave (name can be changed)

6.7.1 Modbus TCP protocol

TCP port	502
Protocol	Internet protocol, version 4 (IPv4)
Network topology	<ul style="list-style-type: none"> • Tree • Star • Line (open daisy chain)
IP configuration	<ul style="list-style-type: none"> • Static IP address • Not supported: <ul style="list-style-type: none"> – BOOTP (Bootstrap Protocol) – DHCP (Dynamic Host Configuration Protocol)
Transmission speed	10 and 100 MBit/s
Data transport layer	EtherNet II, IEEE 802.3
Modbus function codes	1, 2, 3, 4, 15, 16, 23
Read/write register	Maximum 125 read registers and 123 write registers per telegram
Message mode	Server
Input (Target to Originator)	<ul style="list-style-type: none"> • All diagnostics and errors information has the highest priority and can be read by a PLC (refer to the concerned protocol file available at country.burkert.com). • PDO: value, status, unit • Device and modules: status • Functions: value, status

PDO = Process Data Object, Target = Server, Originator = Client.

6.7.2 PROFINET protocol

Product type	Compact field IO device
PROFINET IO specification	V2.3
Network topology	<ul style="list-style-type: none"> • Tree • Star • Ring (closed daisy chain) • Line (open daisy chain)
Network management	<ul style="list-style-type: none"> • LLDP (Link Layer Discovery Protocol) • SNMP V1 (Simple Network Management Protocol) • MIB-II (Management Information Base) • Physical device
Additional supported features	<ul style="list-style-type: none"> • DCP (Discovery and Configuration Protocol) • VLAN- and priority tagging • Shared device • RTC (Real Time Cyclic) protocol: Class 1 • Not supported: <ul style="list-style-type: none"> – IRT (In Real Time)
Transmission speed	100 MBit/s full duplex
Data transport layer	EtherNet II, IEEE 802.3
Maximum supported conformance class	CC-B
Media Redundancy (for ring topology)	MRP client is supported
Minimum cycle time	10 ms
Input cyclic data (device to IO-controller or device to IO-supervisor)	<ul style="list-style-type: none"> • All diagnostics and errors information has the highest priority and can be read by a PLC (refer to the concerned protocol file available at country.burkert.com). • PDO: value, status, unit • Device and modules: status • Functions: value, status
Application Relations (AR)	The device can simultaneously process up to 2 IO-ARs, 1 Supervisor AR and 1 Supervisor DA AR.
GSDml file	Download from: country.burkert.com

PDO = Process Data Object

6.7.3 EtherNet/IP protocol

Protocol	Internet protocol, version 4 (IPv4)
Network topology	<ul style="list-style-type: none"> • Tree • Star • DLR (Device Level Ring) for closed daisy chain • Linear for open daisy chain
IP configuration	<ul style="list-style-type: none"> • Static IP address • BOOTP (Bootstrap Protocol) • DHCP (Dynamic Host Configuration Protocol)
CIP reset services (Common Industrial Protocol)	Reset service (type 0 or type 1) of the Identity object
Transmission speed	10 and 100 MBit/s
Duplex modes	Half duplex, full duplex, auto-negotiation
Data transport layer	EtherNet II, IEEE 802.3
MDI modes (Medium Dependant Interface)	MDI, MDI-X, auto-MDI-X
Predefined standard objects	<ul style="list-style-type: none"> • Identity (0x01) • Message Router (0x02) • Assembly (0x04) • Connection Manager (0x06) • DLR (0x47) • QoS (0x48) • TCP/IP Interface (0xF5) • EtherNet Link (0xF6)
Additional supported features	<ul style="list-style-type: none"> • ACD (Address Conflict Detection) • Integrated switch
RPI (Requested Packet Interval)	<ul style="list-style-type: none"> • minimum: 100 ms • maximum: 9999 ms
Input (Consumer to Producer or Adapter to Scanner)	<ul style="list-style-type: none"> • All diagnostics and errors information has the highest priority and can be read by a PLC (refer to the concerned protocol file available at country.burkert.com). • PDO: value, status, unit • Device and modules: status • Functions: value, status
EDS file	Download from: country.burkert.com

PDO = Process Data Object, Consumer = Server, Producer = Client, Adapter = Server, Scanner = Client.

6.7.4 EtherCAT protocol



Industrial Ethernet interface X1, X2	<ul style="list-style-type: none"> • X1: EtherCAT IN • X2: EtherCAT OUT
Maximum number of cyclic input and output data	512 bytes in total
Maximum number of cyclic input data	1024 bytes
Maximum number of cyclic output data	1024 bytes
Acyclic communication (CoE)	<ul style="list-style-type: none"> • SDO • SDO master-slave • SDO slave-slave (depends on master capacity)
Type	Complex slave
Fieldbus Memory Management Units (FMMUs)	8
Sync Managers	4
Transmission speed	100 Mbit/s
Data transport network	Ethernet II, IEEE 802.3

EtherCAT® is a registered trademark and patented technology, licensed by Beckhoff Automation GmbH, Germany

Installation in the pipe

7	INSTALLATION IN THE PIPE	38
7.1	Safety instructions	38
7.2	Additional documentation	39
7.3	Preparing the device before installation into the pipe	39
7.3.1	Changing the position of the transmitter on the sensor	39
7.3.2	Switching positions of the blind cover and the display module or the Wi-Fi module.....	43
7.4	Recommendations for the installation into the pipe	46
7.5	Installing the device into the pipe	49
7.5.1	Before installing the device into the pipe	49
7.5.2	Installing a device with clamp connections	49
7.5.3	Installing a device with flange connections	49
7.5.4	Installing a device with external-threaded connections according to DIN 11851 series A for pipes according to DIN 11850	50

7 INSTALLATION IN THE PIPE

7.1 Safety instructions



DANGER

Risk of injury due to electrical voltage.

- ▶ Before carrying out work on the system, disconnect the electrical power for all the conductors and isolate it.
- ▶ In accordance with standard UL/EN 61010-1, all equipment connected to the Type 8098 FLOWave L flowmeter shall be double insulated with respect to the mains and all circuits connected to the Type 8098 FLOWave L flowmeter must be limited energy circuits.
- ▶ Observe all applicable accident protection and safety regulations for electrical equipment.

Risk of injury due to pressure in the installation.

- ▶ Before any intervention in the installation, stop the circulation of liquid, cut off the pressure and drain the pipe.
- ▶ Before any intervention in the installation, make sure there is no pressure in the pipe.
- ▶ Observe the dependency between the liquid temperature and the liquid pressure for the fitting used.

If switched on for a prolonged time, risk of burns or fire due to hot device surfaces

- ▶ Do not touch with bare hands.
- ▶ Keep the device away from highly flammable substances and liquids.

Risk of burns due to high liquid temperatures.

- ▶ Do not touch with bare hands the parts of the device that are in contact with the liquid.
- ▶ Use safety gloves to handle the device.
- ▶ Before opening the pipe, stop the circulation of liquid and drain the pipe.
- ▶ Before opening the pipe, make sure the pipe is completely empty.

Risk of injury due to the nature of the liquid.

- ▶ Respect the prevailing regulations on accident prevention and safety relating to the use of dangerous liquids.



WARNING

Risk of injury due to non-conforming installation.

- ▶ The electrical and liquid installations must only be carried out by qualified and authorized personnel with the appropriate tools.



WARNING

Risk of injury due to unintentional switch-on of the power supply or uncontrolled restart of the installation.

- ▶ Take appropriate measures to avoid unintentional activation of the installation.
- ▶ Guarantee a set or controlled process restart after carrying out any device intervention.

CAUTION

Risk of injury due to a heavy device.

A heavy device can fall down during transport or during installation and cause injuries.

- ▶ Transport, install and dismantle a heavy device with the help of another person.
- ▶ Use appropriate tools.

NOTICE

The device will be damaged if you use a tool to turn the blind cover or the display module.

- ▶ Do not use a tool to turn the blind cover or the display module.



Risk of failure or risk of accelerated ageing of electrical components.

- ▶ Observe the dependence between liquid temperature and ambient temperature (see [Fig. 9](#) and [Fig. 10](#)).

7.2 Additional documentation

→ If the device is an ATEX / IECEx device variant, then refer to the ATEX / IECEx supplement for Type 8098 FLOWave L available on the internet at country.burkert.com.

7.3 Preparing the device before installation into the pipe

The device is delivered as described in chapter [5.1](#).

Before installing the device into the pipe, you may:

- change the position of the transmitter on the sensor. Refer to chapter [7.3.1](#).
- switch positions of the display module or of the Wi-Fi module and the blind cover. Refer to chapter [7.3.2](#).

7.3.1 Changing the position of the transmitter on the sensor



These instructions are valid for all the device variants.

The Type SE98 transmitter can have four positions on the Type S097 flow sensor. See [Fig. 13](#).

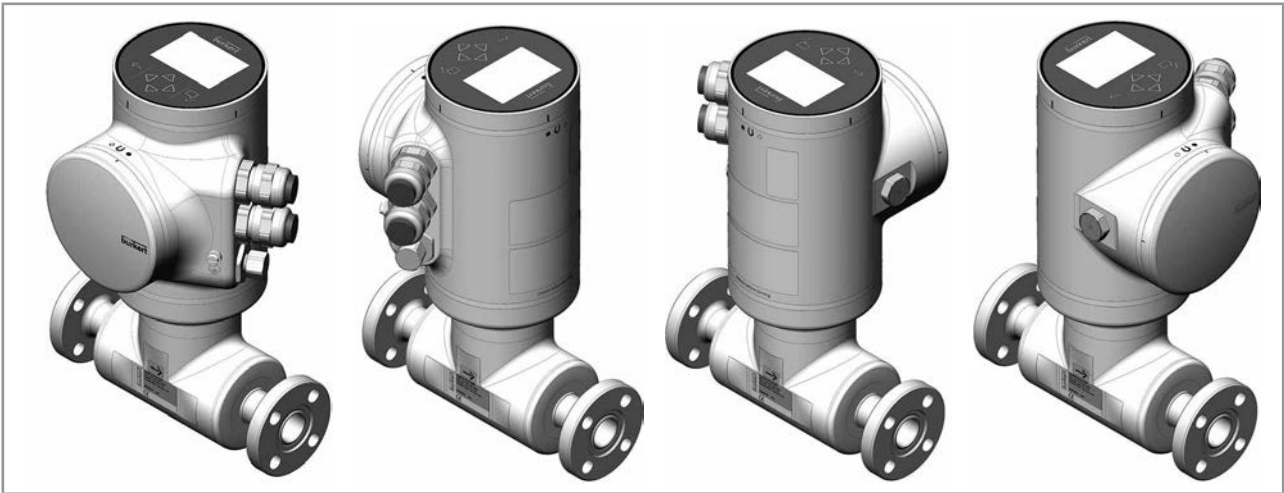
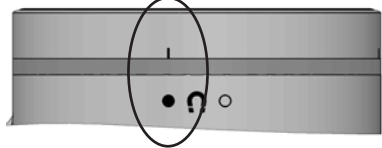



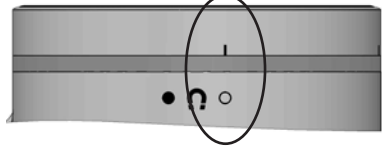

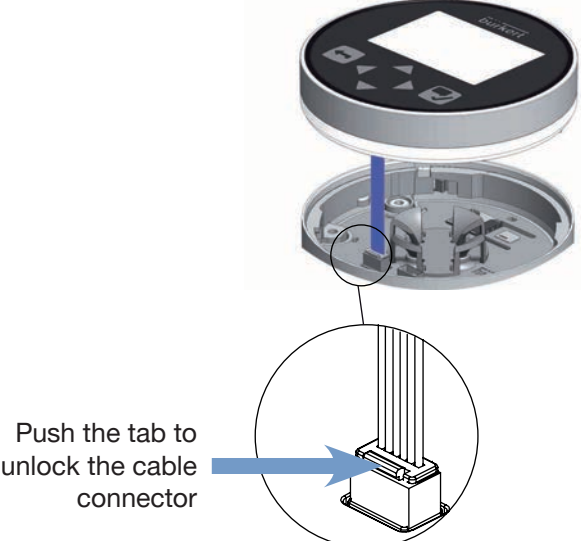
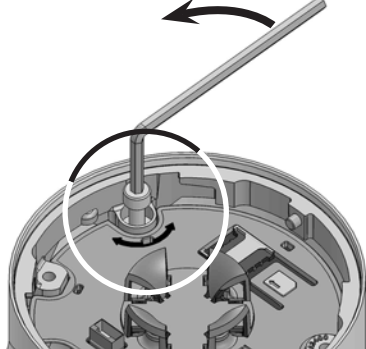
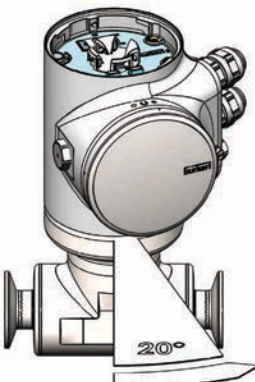

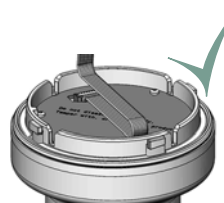
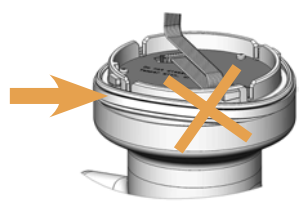

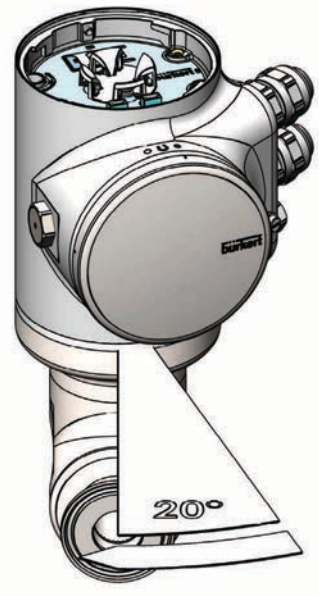

Fig. 13: Possible positions of the transmitter SE98



→ To change the position of the transmitter, do the following:

<p>For safety reasons and to comply with standard UL 61010-1, the blind cover and the display module or the Wi-Fi module are locked.</p> <p>→ Prepare the unlocking magnetic key, which is delivered with the device, to change the position of the transmitter.</p>	 <p>The blind cover or the display module or the Wi-Fi module is locked</p>
<p>1. Put the magnetic key on the  mark related to the display module. You should hear a soft click indicating that the display module or the Wi-Fi module is unlocked. Do not use a tool to turn the display module.</p>	
<p>2. While the magnetic key is on the  mark, turn the display module or the Wi-Fi module by hand only from the locked position to the unlocked position. If you cannot turn the display module or the Wi-Fi module by hand, contact Bürkert.</p>	 <p>The blind cover, the display module or the Wi-Fi module is unlocked</p>

<p>3.  Carefully lift the display module or the Wi-Fi module because a cable connects the display module or the Wi-Fi module to the transmitter.</p> <p>4. Push the tab of the cable connector to disconnect the display module or the Wi-Fi module from the transmitter.</p> <p>5. Remove the display module or the Wi-Fi module and put it on a clean surface to protect the seal from dirt.</p>	 <p>Push the tab to unlock the cable connector</p>
<p>6. Use a size 3 hexagonal key to loosen the screw that is marked with the arrow and that locks the transmitter to the flow sensor.</p>	
<p>7. Hold the flow sensor with one hand and, with the other hand, turn the transmitter by about 20 degrees counterclockwise.</p>	

<p>8.  Lift the transmitter carefully because a cable connects the transmitter to the flow sensor.</p>	
<p>9. If the seal is damaged, replace it. Apply a layer of lithium soap grease to the new seal before you put it in place.</p> <p>10. If the seal is not located in the groove, put it back in the groove.</p>	<div style="display: flex; justify-content: space-around;"> <div style="text-align: center;">  <p>Seal in the groove: correct</p> </div> <div style="text-align: center;">  <p>Seal not in the groove: NOT correct</p> </div> </div>
<p>11. Turn the transmitter to the desired position.</p> <p>12.  Fold the cable in a Z-shape and make sure the cable stays inside the transmitter.</p>	
<p>13. Turn the transmitter by about 20 degrees clockwise.</p>	

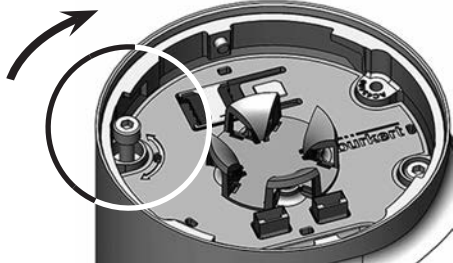
MAN 1000273158 EN Version: M Status: RL (released | freigegeben) printed: 22.06.2022

<p>14. Screw the transmitter clockwise on the flow sensor until the blind cover is perfectly parallel or perpendicular to the axis of the pipe.</p>	
<p>15. Fasten the screw with a size 3 hexagonal key to a tightening torque of 1.3 ± 0.5 Nm (0.96 ± 0.37 ft·lbf)</p>	
<p>16. Connect the display module or the Wi-Fi module to the transmitter.</p> <p>17. Put the mark of the cover on the unlocked marking of the transmitter housing and screw the cover clockwise on the transmitter until the mark is on the locked position. You should hear a click.</p>	

7.3.2 Switching positions of the blind cover and the display module or the Wi-Fi module

CAUTION

Risk of injury due to a heavy device.

A heavy device can fall down during transport or during installation and cause injuries.

- ▶ Transport, install and dismantle a heavy device with the help of another person.
- ▶ Use appropriate tools.

 These instructions are valid for all the device variants.

Upon delivery, a display module is screwed on the top and a blind cover is screwed on the housing side.

→ To switch positions of the display module or the Wi-Fi module and the blind cover, do the following:

For safety reasons and to comply with standard UL 61010-1, the blind cover and the display module or the Wi-Fi module are locked.

→ Prepare the unlocking magnetic key, which is delivered with the device.

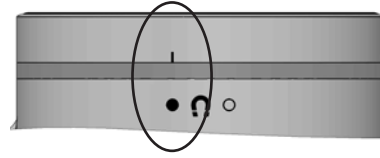

The blind cover or the display module or the Wi-Fi module is locked

1. Put the magnetic key on the  mark related to the display module or the Wi-Fi module. You should hear a soft click indicating that the display module or the Wi-Fi module is unlocked. Do not use a tool to turn the display module or the Wi-Fi module.



2. While the magnetic key is on the  mark, turn the display module or the Wi-Fi module by hand only from the locked position to the unlocked position. If you cannot turn the display module or the Wi-Fi module by hand, contact Bürkert.

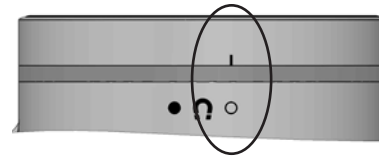

The display module or the Wi-Fi module is unlocked

3. Carefully lift the display module or the Wi-Fi module because a cable connects the display module or the Wi-Fi module to the transmitter.
4. Push the tab of the cable connector to disconnect the display module or the Wi-Fi module from the transmitter.
5. Remove the display module or the Wi-Fi module and put it on a clean surface to protect the seal from dirt.



Push the tab to unlock the cable connector

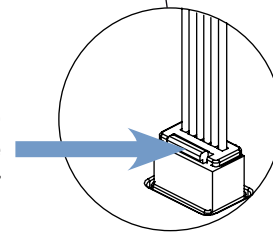



6. Put the magnetic key on the  mark related to the blind cover. You should hear a click indicating that the blind cover is unlocked. Do not use a tool to turn the blind cover.
7. Turn the blind cover by hand only to the unlocked position and remove it. If you cannot turn the blind cover by hand, contact Bürkert.



8. Put the cable of the display module or the Wi-Fi module through the front opening.
9. Connect the cable to the connector, as shown in the figure.
10. Put the mark of the display module or the Wi-Fi module on the unlocked marking of the transmitter housing and screw the cover clockwise on the transmitter until the mark is on the locked position.

Connect the cable here

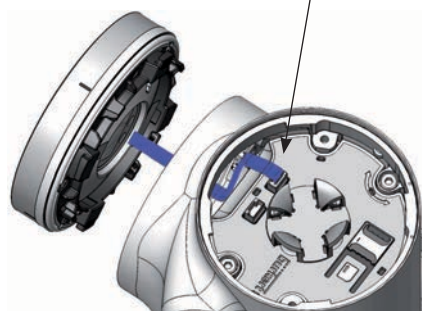

11. Put the mark of the blind cover on the unlocked marking of the top of the transmitter housing.



12. Screw the blind cover clockwise on the transmitter until the mark is on the locked position. You should hear a click.

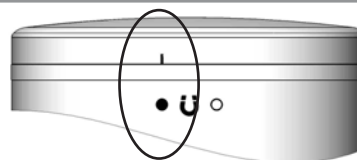

The blind cover is locked.

7.4 Recommendations for the installation into the pipe

The device can be installed into either horizontal, oblique or vertical pipes. But an installation on a vertical pipe is better to prevent air bubbles or gas bubbles to remain in the sensor measurement-tube.

In any case and according to the device variant, make sure to respect the following recommendations:

- Protect this device against electromagnetic interference, ultraviolet rays and, when installed outdoors, the effects of climatic conditions.
- If the mass of the device could kink the pipe, install adapted pipe supports before mounting the device in the pipe.
- Always install a heavy device with the help of another person and with the use of appropriate tools.
- If the liquid temperature is subject to variations, make sure that the device can expand freely.
- Make sure the DN of the measurement tube is suited to the flow velocity: refer to the data sheet of the device, available at country.burkert.com.



The device is not intended to measure the flow rate of liquids if gas bubbles are present, whatever the origin of the bubbles (air intake, cavitation, degassing ...).

- Choose a location with enough free space to put the magnetic key on the symbol at the side of the device.
- Install the device upstream a valve or any equipment that changes the pipe diameter or the pipe direction.
- If you cannot install the device upstream a valve or any equipment that changes the pipe diameter or the pipe direction, observe the straight downstream distances depending on the design of the pipes. Refer to standard ISO 9104:1991 and Fig. 14. If these recommendations cannot be complied with, contact Bürkert.

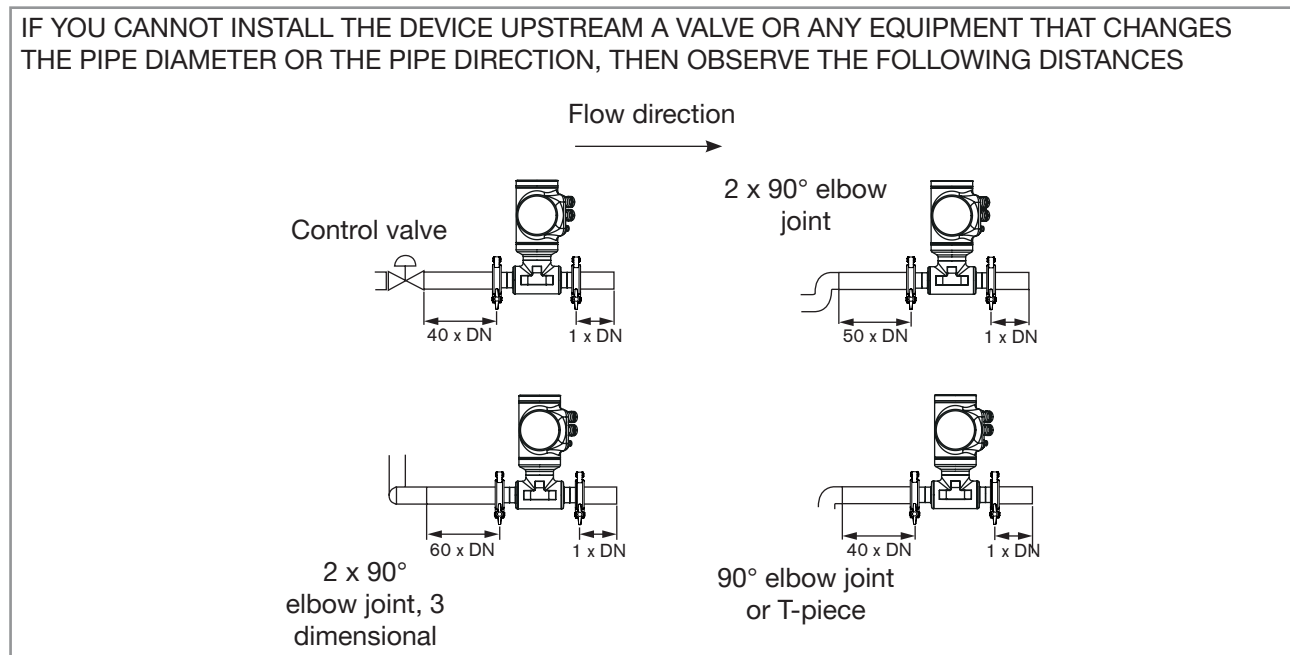

Fig. 14: Upstream and downstream straight distances for special pipe designs (example for a horizontal installation)

→ To make sure that neither air bubbles nor gas bubbles trouble the measuring, install the device as recommended in Fig. 15.

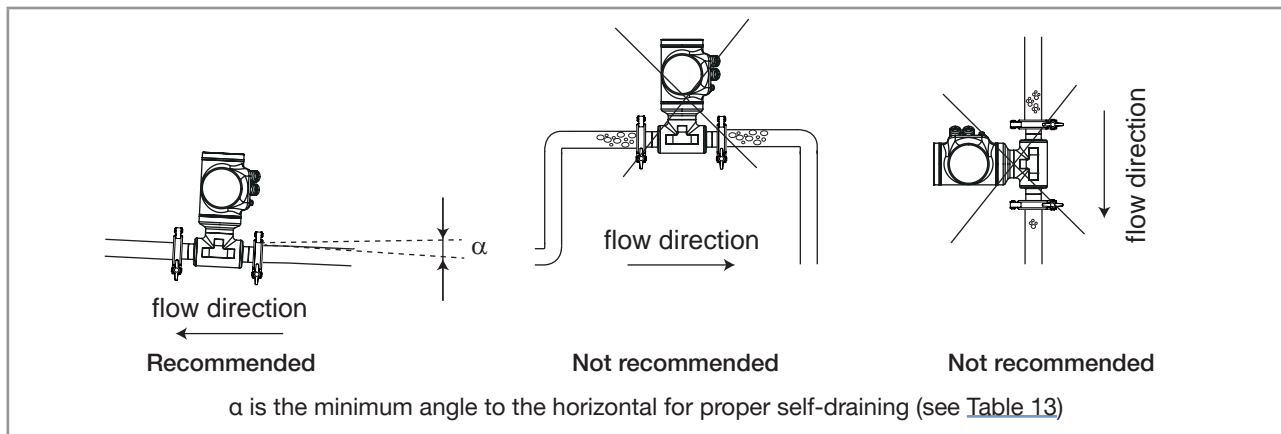

Fig. 15: Orientation of a device to avoid air bubbles and gas bubbles

→ To allow proper self-draining and to respect the 3A and EHEDG requirements, install the device into a pipe with a minimum angle against the horizontal. See Table 13.

Table 13: Minimum angle against the horizontal for proper self-draining

Type of process connection	Standards the process connections conform to	Angle against the horizontal
clamp	<ul style="list-style-type: none"> • DIN 32676 series A • DIN 11864-3 series A • SMS 3017 / ISO 2852 for pipes according to SMS 3008 	For DN15 to DN50: minimum 5°
		For DN8 and DN65 to DN100: minimum 3°
flange	DIN 11864-2 series A	For DN15 to DN50: minimum 5°
		For DN8 and DN65 to DN100: minimum 3°
clamp	<ul style="list-style-type: none"> • ASME BPE (DIN 32676 series C) • DIN 32676 series B • DIN 11864-3 series B • DIN 11864-3 series C 	minimum 3°
flange	<ul style="list-style-type: none"> • DIN 11864-2 series B • DIN 11864-2 series C 	minimum 3°
external threaded	DIN 11851 series A	minimum 3°

→ If the pipe is fitted with a thermal insulation, do not thermally insulate the measurement tube of the device to make sure that the temperature in the device is less than 70 °C. Refer to Fig. 16 and, for the minimum supply voltage, to chapter 8.3.

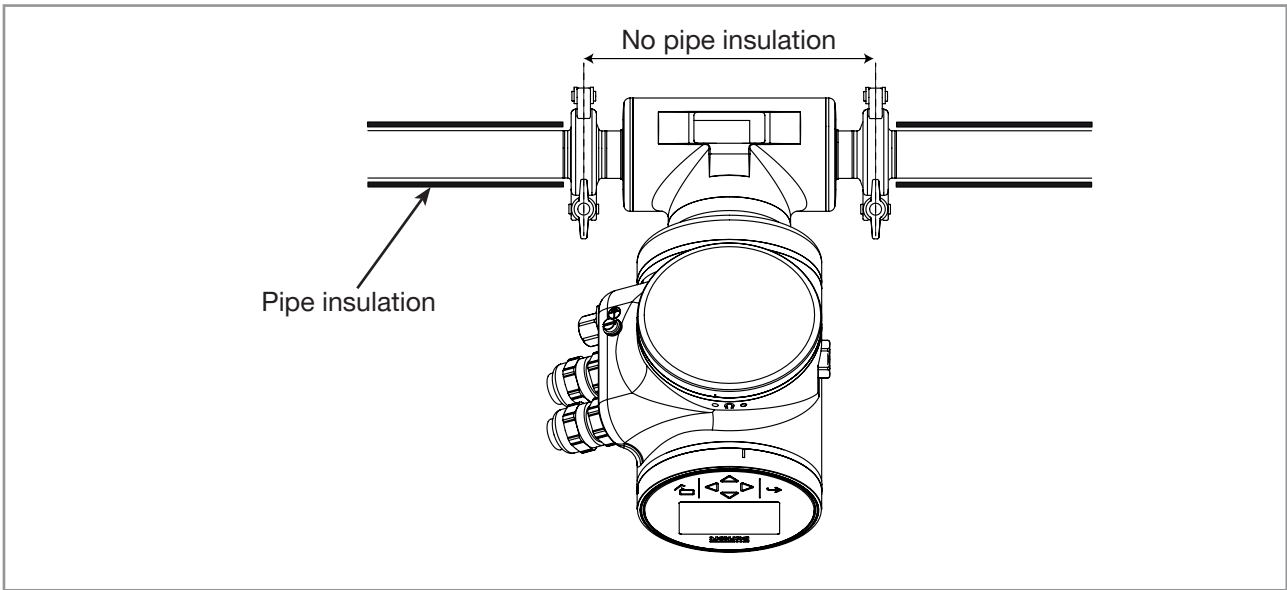
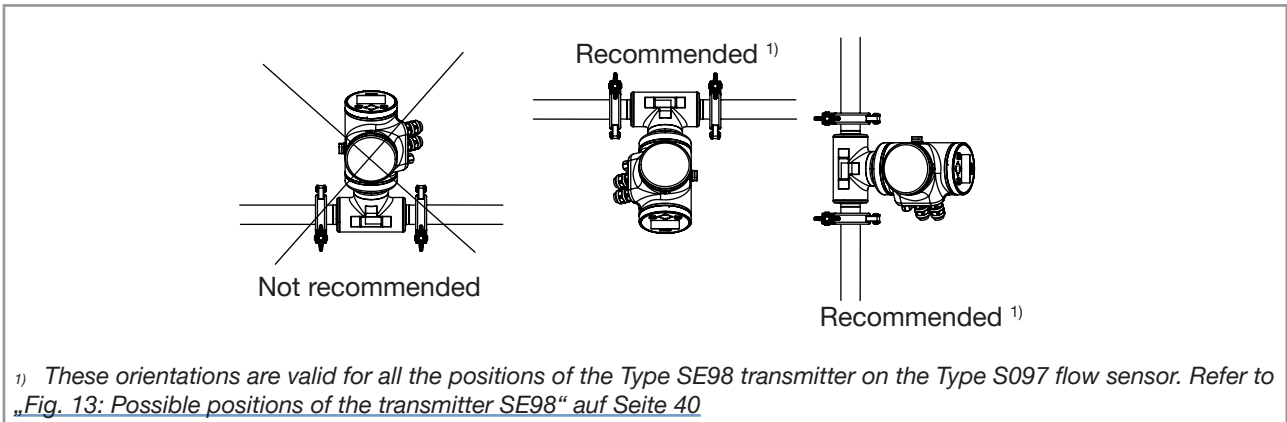

Fig. 16: Thermal insulation of the pipe

→ To make sure the internal temperature of the transmitter with cable glands does not exceed the authorized maximum value, install the device as recommended in Fig. 17.

→ To make sure the internal temperature of the transmitter does not exceed the authorized maximum value, install an Ethernet device variant as recommended in Fig. 18.



¹⁾ These orientations are valid for all the positions of the Type SE98 transmitter on the Type S097 flow sensor. Refer to „Fig. 13: Possible positions of the transmitter SE98“ auf Seite 40

Fig. 17: Orientation of a device variant with cable glands to avoid effects of high liquid temperatures

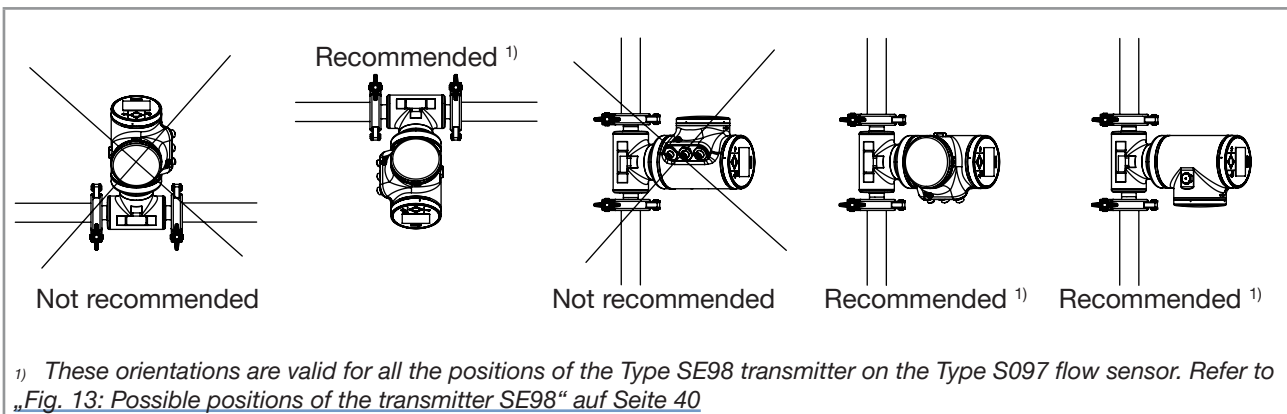

¹⁾ These orientations are valid for all the positions of the Type SE98 transmitter on the Type S097 flow sensor. Refer to „Fig. 13: Possible positions of the transmitter SE98“ auf Seite 40

Fig. 18: Orientation of an Ethernet device variant to permit the heat dissipation

7.5 Installing the device into the pipe



CAUTION

Risk of injury due to a heavy device.

A heavy device can fall down during transport or during installation and cause injuries.

- ▶ Transport, install and dismantle a heavy device with the help of another person.
- ▶ Use appropriate tools.

7.5.1 Before installing the device into the pipe

- Prepare the device as described in chapter [7.3](#).
- Follow the recommendations given in chapter [7.4](#).

7.5.2 Installing a device with clamp connections

The device manufacturer does not supply any gaskets for the process connections.

- If the installation must be EHEDG-compliant and the device is fitted with clamp connections according to ASME BPE (DIN 32676 series C), DIN 32676 series A, DIN 32676 series B or SMS 3017 / ISO 2852 for pipes according to SMS 3008, then use EHEDG-compliant gaskets from Combifit International B.V.
- To make sure that you use EHEDG-compliant gaskets, refer to the "EHEDG Position Paper" available on the EHEDG website.
- The clamp connections according to DIN 11864-3 series A, B and C are hygienic connections. You can use any gaskets that are adapted to the process.
- Make sure that the gaskets on the clamp connections are in good condition.
- Place gaskets adapted to the process (temperature, liquid type) in the grooves of the clamp connections.
- Attach the clamp connections to the pipe with clamp collars. Make sure that tightening the clamp does not create bulges at the gaskets. Gasket bulges can lead to wrong measurements.

7.5.3 Installing a device with flange connections

- The flange connections according to DIN 11864-2 series A, B and C are hygienic connections. You can use any gaskets that are adapted to the process.
- Make sure that the gaskets on the flange connections are in good condition.
- Place gaskets adapted to the process (temperature, liquid type) in the grooves of the flange connections.
- Use bolts with dimensions as given in the relevant flange standard and adapted to the process.
- Tighten the bolts to a torque as given in the relevant flange standard to fix the fitting to the pipe.

7.5.4 Installing a device with external-threaded connections according to DIN 11851 series A for pipes according to DIN 11850

To install this device variant, respect the mounting standards that are applicable to the process.

→ Supply the following accessories that are not delivered by the device manufacturer. The accessories must be adapted to the process and to the device:

- 2 round slotted nuts
- 2 conical ferrules
- 2 gaskets that respect the standard DIN 11851. If the installation must be EHEDG-compliant, then supply EHEDG-compliant gaskets. For an EHEDG-compliant use, Burkert recommends gaskets of one of the following type:
 - ASEPTO-STAR k-flex upgrade gaskets from Kieselmann GmbH, Germany,
 - SKS gaskets set DIN 11851 EHEDG with EPDM or FKM inner gasket from Siersema Componenten Service (S.K.S.) B.V., Netherlands

Installation procedure:

1. Put the round slotted nuts on the pipe. Respect the mounting direction of the round slotted nuts so that they can be screwed on the external-threaded connections of the device. Refer to [Fig. 19](#).

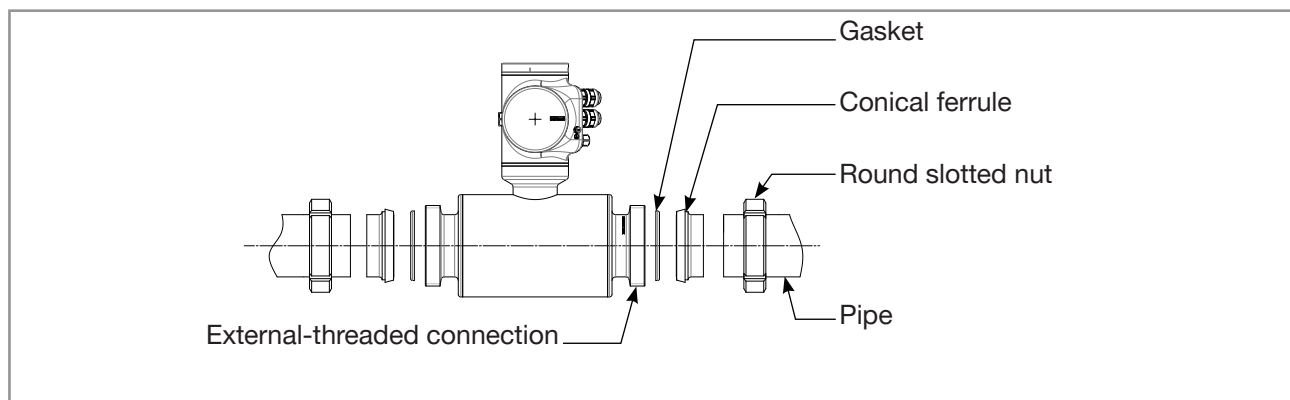

Fig. 19: *Mounting order of the accessories*

2. Weld the conical ferrules to the pipe.
3. Place the gaskets in the grooves of the external-threaded connections of the device. Respect the mounting direction of the gaskets.
4. Screw the round slotted nuts and tighten them according to the mounting standards that are applicable to the process.

Electrical installation

8	ELECTRICAL INSTALLATION.....	52
8.1	Safety instructions	52
8.2	Additional documentation	54
8.3	Connecting the device to a power supply	54
8.4	Connecting the device to a bus / CANopen network	55
8.5	Activating the device internal termination resistor.....	57
8.6	Specifications of the cables for the M20x1.5 cable glands (device variant with cable glands).....	57
8.7	Specifications of the conductors for the 12 push-in terminal strip	58
8.8	Terminal assignment of the 12 push-in terminal strip	58
8.9	Opening the front of the transmitter.....	59
8.10	Wiring the device through the M20x1.5 cable glands in stainless steel (device variant with cable glands)	61
8.11	Wiring the device through the M20x1.5 cable glands in nickel plated brass (device variant with cable glands).....	63
8.12	Connecting the functional earth (device variant with two M20x1.5 cable glands)	65
8.13	Connecting the device to a 12...35 V DC power supply through the M20x1.5 cable glands (device variant with cable glands).....	65
8.14	Wiring output 1 (analogue) and output 3 configured as an analogue output (device variant with cable glands).....	67
8.15	Wiring output 2 (digital) and output 3 configured as a digital output (device variant with cable glands)	68
8.16	Knowing the status of the Ethernet network (device variant with two 4-pin M12 female connectors – Ethernet device variant)	69
8.17	Specifications of the cables and conductors for the 4-pin M12 female connectors.....	70
8.18	Connecting the device to an Ethernet network (device variant with two 4-pin M12 female connectors – Ethernet device variant)	70
8.19	Connecting the functional earth (device variant with two 4-pin M12 female connectors – Ethernet device variant)	71

8 ELECTRICAL INSTALLATION

8.1 Safety instructions



DANGER

Risk of injury due to electrical voltage.

- ▶ Before carrying out work on the system, disconnect the electrical power for all the conductors and isolate it.
- ▶ In accordance with standard UL/EN 61010-1, all equipment connected to the Type 8098 FLOWave L flowmeter shall be double insulated with respect to the mains and all circuits connected to the Type 8098 FLOWave L flowmeter must be limited energy circuits.
- ▶ Observe all applicable accident protection and safety regulations for electrical equipment.

Risk of injury due to pressure in the installation.

- ▶ Before any intervention in the installation, stop the circulation of liquid, cut off the pressure and drain the pipe.
- ▶ Before any intervention in the installation, make sure there is no pressure in the pipe.
- ▶ Observe the dependency between the liquid temperature and the liquid pressure for the fitting used.

If switched on for a prolonged time, risk of burns or fire due to hot device surfaces

- ▶ Do not touch with bare hands.
- ▶ Keep the device away from highly flammable substances and liquids.

Risk of burns due to high liquid temperatures.

- ▶ Do not touch with bare hands the parts of the device that are in contact with the liquid.
- ▶ Use safety gloves to handle the device.
- ▶ Before opening the pipe, stop the circulation of liquid and drain the pipe.
- ▶ Before opening the pipe, make sure the pipe is completely empty.

Risk of injury due to the nature of the liquid.

- ▶ Respect the prevailing regulations on accident prevention and safety relating to the use of dangerous liquids.

 **WARNING**

Risk of injury due to non-conforming installation.

- ▶ The electrical and liquid installations must only be carried out by qualified and authorized personnel with the appropriate tools.
- ▶ Fit a circuit breaker or a switch to the electrical installation of the building in which the device is installed.
- ▶ Install the circuit breaker or the switch in an easily accessible place.
- ▶ Identify the circuit breaker or the switch as the disconnecting component for the electrical power supply to the device.
- ▶ Install overload devices that are appropriate for electrical installation.
- ▶ Observe standard NF C 15-100 / IEC 60364.

 **WARNING**

Risk of injury due to unintentional switch on of the power supply or uncontrolled restart of the installation.

- ▶ Take appropriate measures to avoid unintentional activation of the installation.
- ▶ Guarantee a set or controlled process restart after carrying out any intervention on the device.

 **CAUTION**

Risk of injury due to a heavy device.

A heavy device can fall down during transport or during installation and cause injuries.

- ▶ Transport, install and dismantle a heavy device with the help of another person.
- ▶ Use appropriate tools.

NOTICE

The device will be damaged if you use a tool to turn the blind cover or the display module.

- ▶ Do not use a tool to turn the blind cover or the display module.

NOTICE

If you try to remove the nut from a stainless steel M20x1.5 cable gland, the device is no longer tight.

- ▶ Do not remove the nut of a stainless steel M20x1.5 cable gland. The nut of a stainless steel M20x1.5 cable gland cannot be removed.
- ▶ Turn the nut until the stop. If you turn beyond the stop, the cable gland unscrews from the device and the device is no longer tight.

NOTICE

If the screwed plug of a 5-pin M12 male connector is removed, the device is not tight.

- ▶ If the 5-pin M12 male connector is not used, do not remove the screwed plug.
- ▶ Screw the plug to the 5-pin M12 male connector to a torque of 2 Nm.

NOTICE

If the screwed plug of a 4-pin M12 female connector is removed, the device is not tight.

- ▶ If the 4-pin M12 female connector is not used, do not remove the screwed plug.
- ▶ Screw the plug to the 4-pin M12 female connector to a torque of 1.3 Nm (0.96 ft·lbf).

NOTICE

The device with M20x1.5 cable glands is not tight if a cable gland is not used

- ▶ Make sure the unused M20x1.5 cable glands are sealed with the supplied plugs.
- ▶ When the blind plug is inserted, screw the cable-gland nut in stainless steel to a torque of 3 Nm (2.21 ft·lbf).
- ▶ When the blind plug is inserted, screw the cable-gland nut in nickel plated brass to a torque of 8 Nm (5.90 ft·lbf).



▶ Use a high quality electrical power supply, filtered and regulated.

▶ Do not install the cables near high voltage or high frequency cables; if this cannot be avoided, observe a minimum distance of 30 cm.



▶ On a device with M20x1.5 cable glands, put only one cable in each cable gland.



▶ To do the electrical installation of a device with two 4-pin M12 female connectors (Ethernet device variant) that is connected to an Ethernet network, observe standard ISO / IEC 61918.

8.2 Additional documentation

- For more information on büS, read the cabling guide available in English and in Japanese (Cabling_guide_for_büS/EDIP.pdf) at country.burkert.com.
- For more information on CANopen that is related to the device, refer to the Operating Instructions "CANopen Network configuration" at country.burkert.com.
- If the device is an ATEX / IECEx device variant, then refer to the ATEX / IECEx supplement for Type 8098 FLOWave L available on the internet at country.burkert.com.

8.3 Connecting the device to a power supply

The device is wired in the factory to be easily energized through the 5-pin M12 male connector.

→ Connect the device with two 4-pin M12 female connectors (Ethernet device variant) to a 12...35 V DC power supply through the 5-pin M12 male connector; Refer to chapter [8.4](#).



▶ A device with two 4-pin M12 female connectors (Ethernet device variant) must be energized through the 5-pin M12 male connector.

→ Connect the device with M20x1.5 cable glands to a 12...35 V DC power supply:

- either through the 5-pin M12 male connector, refer to chapter [8.4](#).
- or through the M20x1.5 cable glands and the terminal strip located in the transmitter housing. Refer to chapter [8.13](#) for the wiring procedure.

The minimum voltage to be supplied depends on the device variant, on the liquid temperature and on the ambient operating temperature: see Fig. 20 and Fig. 21.

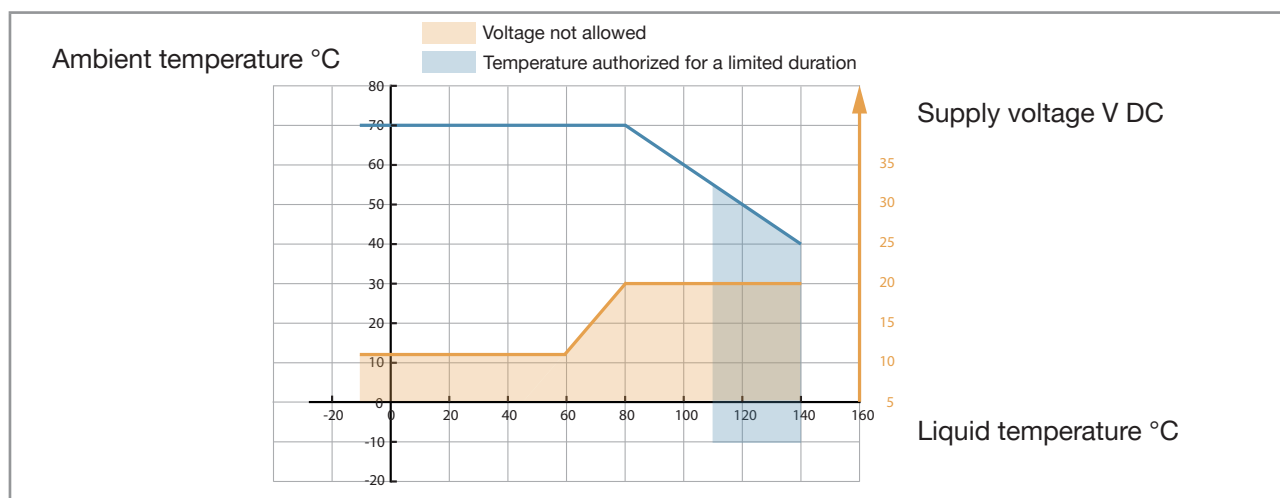

Fig. 20: Minimum supply voltage depending on the ambient temperature and the liquid temperature, device variant with two M20x1.5 cable glands and one 5-pin M12 male connector

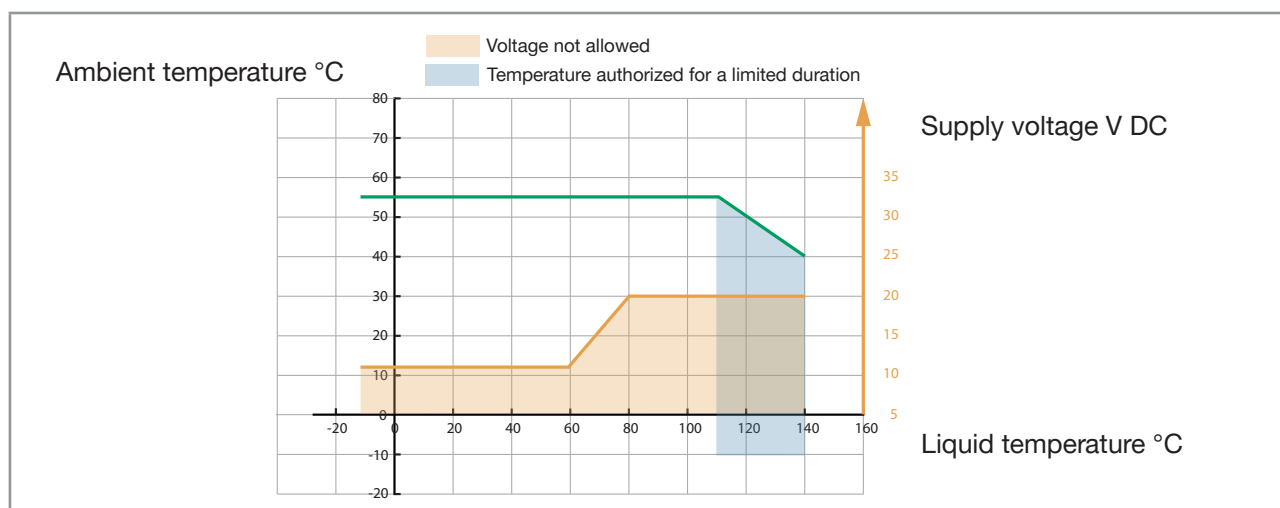

Fig. 21: Minimum supply voltage depending on the ambient temperature and the liquid temperature, device variant with two 4-pin M12 female connectors and one 5-pin M12 male connector (Ethernet device variant)

8.4 Connecting the device to a bÜS / CANopen network

For a correct operation of the device, use a 5-pin M12 female connector in stainless steel with shield connection. The bÜS cable that is available from Bürkert has an external diameter of 8.2 mm.

→ Make sure that the bÜS cable passes through the 5-pin M12 female connector.

→ Observe the specifications for the cable and conductors, that are given by the manufacturer of the 5-pin female connector.

The 5-pin M12 male connector (A-coding) is used to connect the device:

- To a 12...35 V DC power supply and/or
- To the bÜS / CANopen network.

→ To connect the device, remove the screwed plug of the 5-pin M12 male connector and store the screwed plug in a safe and clean place.



Risk of damage to the device if an M12 connector is unused.

▶ Put a screwed plug on all the unused M12 connectors.



Malfunction of the internal and external communication if the 5-pin M12 male connector is not used to connect the device to a bus fieldbus or a CANopen fieldbus.

▶ Make sure pin 4 (CAN_H) and pin 5 (CAN_L) are both contact free if the 5-pin M12 male connector is not connected to a bus fieldbus or a CANopen fieldbus.

→ If the device is connected to a bus network or to a CANopen network and installed at one end of the bus network or of the CANopen network, either install one or two 120 Ω termination resistors in the line or activate the device internal termination resistor: see chapter 8.5. The bus or CANopen line must be adapted to reached 60 Ω.



If a device with two 4-pin M12 female connectors (Ethernet device variant) is connected to an Ethernet network, you must connect it to a bus / CANopen network for the configuration of the device with the software Bürkert Communicator.

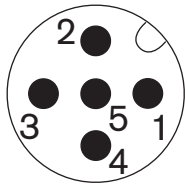

- Pin 1: CAN shield
- Pin 2: 12...35 V DC
- Pin 3: GND
- Pin 4: CAN_H
- Pin 5: CAN_L

Fig. 22: Pin assignment of the 5-pin M12 male connector

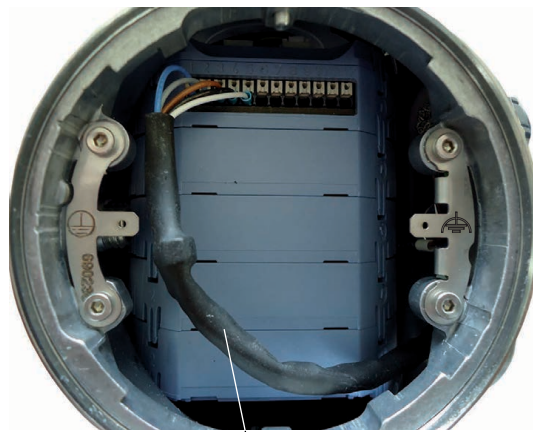

Cable and conductors connected inside the device to the 5-pin M12 male connector

Fig. 23: Wiring ex works of the 12 push-in terminal strip to the 5-pin M12 male connector











8.5 Activating the device internal termination resistor

The device has an internal termination resistor that can be activated if the device is installed at one end of a bÜS network or of a CANopen network.

If you activate the device internal termination resistor, do not install more than one termination resistor at the same end of the bÜS network or of the CANopen network.

To have an adapted network, connect one termination resistor at each end of the network.

To activate the device internal termination resistor, do the following:

- Go to the **CONFIGURATION** view.
-  **General settings**
-  Confirm to access the **Parameter** view.
-  **bÜS** ----- 
-  **Advanced** ----- 
-  **Termination resistor** ----- 
-  **On**
-  Save.

 The internal termination resistor is activated.

8.6 Specifications of the cables for the M20x1.5 cable glands (device variant with cable glands)

Table 14: Specifications of the cables for the M20x1.5 cable glands in nickel plated brass

Specification of the cables	Recommended value
Electromagnetic protection (EMC)	Shielded
Diameter	5...14 mm
Maximum operating temperature	80 °C or higher

Table 15: Specifications of the cables for the M20x1.5 cable glands in stainless steel

Specification of the cables	Recommended value
Electromagnetic protection (EMC)	Shielded
Diameter	6...12 mm
Maximum operating temperature	80 °C or higher

8.7 Specifications of the conductors for the 12 push-in terminal strip

Table 16: Specifications of the conductors for the terminal strip

Specification of the conductors	Recommended value range
Cross section of a solid conductor H05(07) V-U	0.25...1.5 mm ²
Cross section of a stranded conductor H05(07) V-K, with a wire ferrule but without collar	0.25...1.5 mm ²
Cross section of a stranded conductor H05(07) V-K, with a wire ferrule with a plastic collar	0.25...0.75 mm ²
Cross section of other kinds of conductors	0.2...1.5 mm ² (AWG24...AWG16)

8.8 Terminal assignment of the 12 push-in terminal strip

The terminal strip located in the transmitter housing has 12 push-in terminals.

→ To access the 12 push-in terminal strip, open the front of the transmitter; see chapter 8.9.



Fig. 24: Wiring ex works of the 12 push-in terminal strip

→ If you need to disconnect a conductor, first push the terminal with a slot screwdriver 3.0 mm (any length) and a force of max. 40 N.

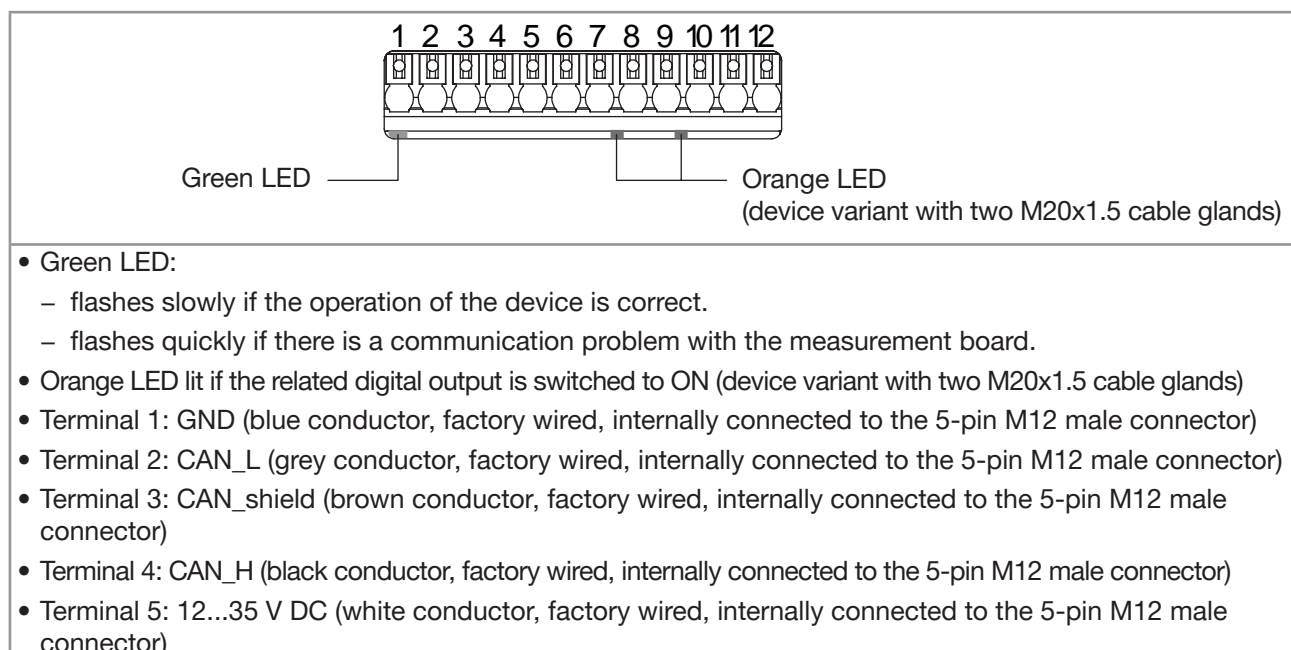



On a device with two 4-pin M12 female connectors (Ethernet device variant), do not use terminals 6 to 12.

- Terminal 6: GND (for the connection of the power supply through the M20x1.5 cable glands)
- Terminal 7: negative output 3 (analogue output or digital output)
- Terminal 8: positive output 3 (analogue output or digital output)
- Terminal 9: negative output 2 (digital output)
- Terminal 10: positive output 2 (digital output)
- Terminal 11: negative output 1 (analogue output)
- Terminal 12: positive output 1 (analogue output)

Fig. 25: Terminal assignment of the 12 push-in terminal strip located in the transmitter housing

8.9 Opening the front of the transmitter

To open the front of the transmitter housing, remove either the blind cover or the display module or the Wi-Fi module.

Procedure to open the front of the transmitter if the blind cover is on the front of the device

1. Put the magnetic key on the  mark related to the blind cover. You should hear a click indicating that the blind cover is unlocked. Do not use a tool to turn the blind cover.
2. Turn the blind cover by hand to the unlocked position and remove it.



Fig. 26: Procedure to open the front of the transmitter if the blind cover is on the front of the device

Procedure to open the front of the transmitter if the display module or the Wi-Fi module is on the front of the device



<ol style="list-style-type: none"> 1. Remove the blind cover from the top of the transmitter. 2. Put the magnetic key on the  mark related to the display module or the Wi-Fi module. You should hear a click indicating that the display module or the Wi-Fi module is unlocked. Do not use a tool to turn the display module or the Wi-Fi module. 3. Turn the display module or the Wi-Fi module by hand to the unlocked position. 	
 <ol style="list-style-type: none"> 4. Carefully pull the display module or the Wi-Fi module because a cable connects the display module or the Wi-Fi module to the transmitter. 5. Push the tab of the cable connector to disconnect the display module or the Wi-Fi module from the transmitter. 6. Remove the display module or the Wi-Fi module and put it on a clean surface to protect the seal from dirt. 	<p>Push the tab to unlock the cable connector</p> 

Fig. 27: Procedure to open the front of the transmitter if the display module or the Wi-Fi module is on the front of the device

8.10 Wiring the device through the M20x1.5 cable glands in stainless steel (device variant with cable glands)

! Put only one cable in each cable gland.

→ Prepare cables that obey the specifications given in chapter 8.6 and chapter 8.7.

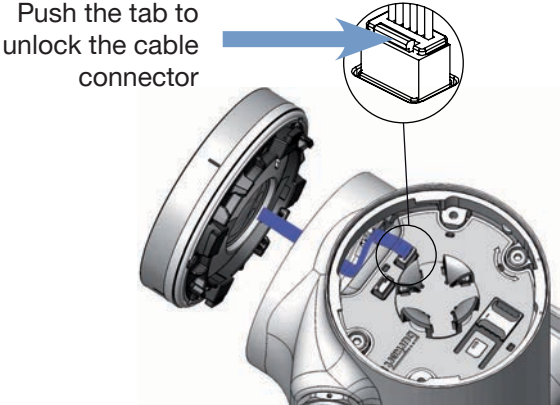
→ To open the front of the transmitter, follow the instructions given in chapter 8.9.

1. Use a size 2 hexagonal key to loosen the 2 screws of the functional earth plate.

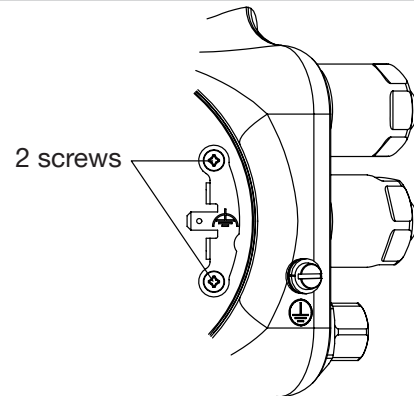

2. Strip 100 mm of the cable.

3. Reduce the shield to 20 mm.

4. Expose 8 mm of the conductors.

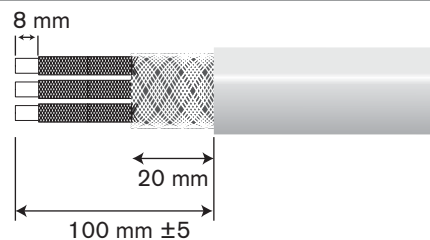

5. Loosen the nut of the cable gland.

6. Do not remove the nut of a stainless steel M20x1.5 cable gland. The nut of a stainless steel M20x1.5 cable gland cannot be removed.

7. Turn the nut until the stop. If you turn beyond the stop, the cable gland unscrews from the device and the device is no longer tight.

8. Remove the blind plug of the cable gland and store the blind plug in a safe and clean place.

9. Put the cable through the cable gland as shown in the figure.

10. Use a size 22 hexagonal key to tighten the cable gland to a torque of 5 Nm (3.7 ft-lbf).

11. Attach each cable to the functional earth plate. The shield must be in contact with the functional earth plate.

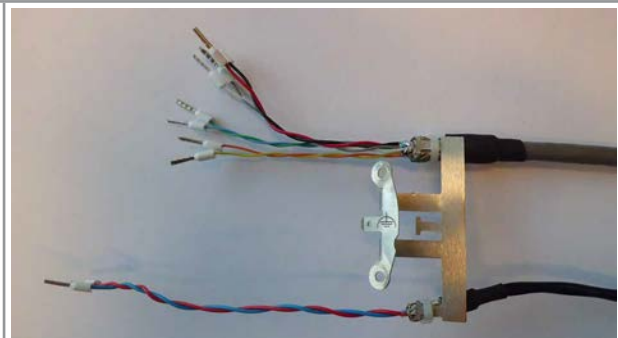

12. Put the functional earth plate in its original place.
13. Use a size 10 hexagonal key to tighten the 2 screws of the functional earth plate to a torque of 0.2 Nm (0.15 ft·lbf).

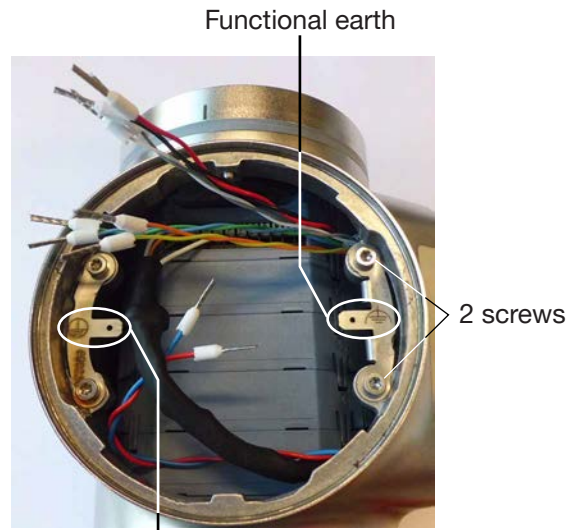



IT IS NOT MANDATORY TO
CONNECT THE DEVICE TO A
PROTECTIVE EARTH - MEANT
FOR FUTURE USE

14. Put each conductor in the correct terminal of the terminal strip.
15. To connect the 12...35 V DC power supply through the cable glands, refer to chapter [8.13](#).
16. To connect the outputs, refer to chapter [8.14](#) and chapter [8.15](#).
17. Connect the functional earth conductor. See chapter [8.12](#).
18. If the display module or the Wi-Fi module is removed, connect it back.
19. Close the front and the top of the transmitter housing.

Fig. 28: *Wiring the device through the M20x1.5 cable glands in stainless steel*

8.11 Wiring the device through the M20x1.5 cable glands in nickel plated brass (device variant with cable glands)

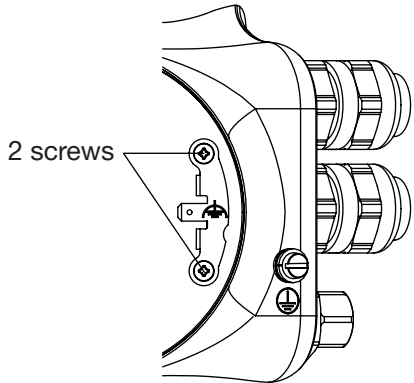
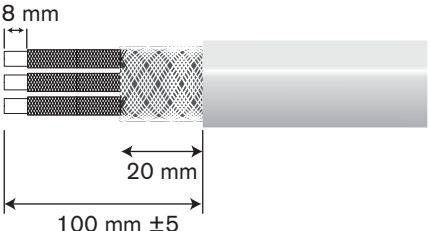
! Put only one cable in each cable gland.

<p>→ Prepare cables that obey the specifications given in chapter 8.6 and chapter 8.7.</p> <p>→ To open the front of the transmitter, follow the instructions given in chapter 8.9.</p> <p>1. Use a size 10 hexagonal key to loosen the 2 screws of the functional earth plate.</p>	 <p>2 screws</p>
<p>2. Strip 100 mm of the cable.</p> <p>3. Reduce the shield to 20 mm.</p> <p>4. Expose 8 mm of the conductors.</p>	 <p>8 mm</p> <p>20 mm</p> <p>100 mm ± 5</p>
<p>5. Loosen the nut of the cable gland.</p> <p>6. Remove the blind plug of the cable gland and store the blind plug in a safe and clean place.</p> <p>7. If the cable diameter is between 5 and 9 mm, put the cable through the cable gland as shown in the figure.</p> <p>8. Use a size 24 hexagonal key to tighten the cable gland to a torque of 10 Nm (7.4 ft·lbf).</p>	
<p>9. If the cable diameter is between 9 and 14 mm,</p> <p>→ vertically put a screwdriver between the two seals,</p> <p>→ lift the inner seal and remove it.</p> <p>→ Put the cable through the cable gland.</p> <p>→ Use a size 24 hexagonal key to tighten the cable gland to a torque of 10 Nm (7.4 ft·lbf).</p>	

10. Attach each cable to the functional earth plate.
The shield must be in contact with the functional earth plate.

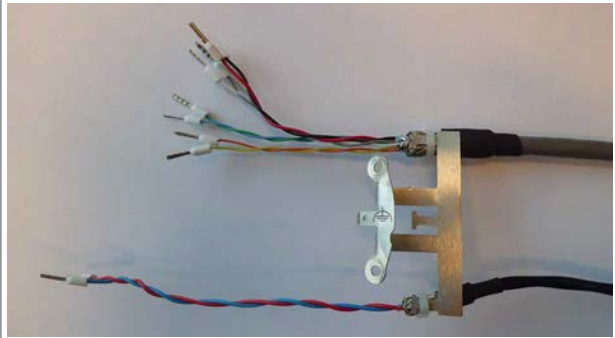

11. Put the functional earth plate in its original place.

12. With an hexagonal key size 10, tighten the 2 screws of the functional earth plate to a torque of 0.2 Nm (0.15 ft·lbf).

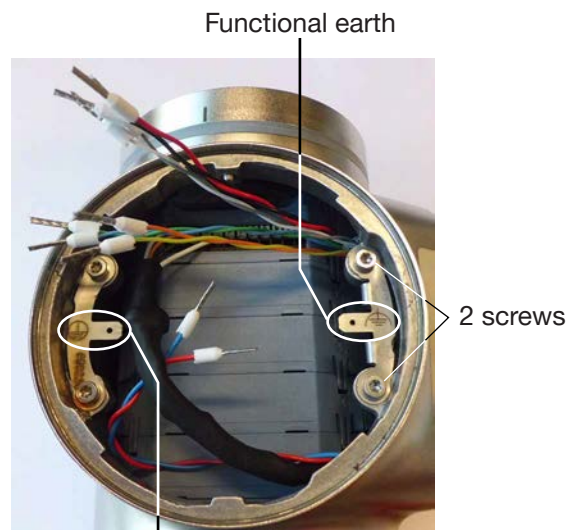

13. Put each conductor in the correct terminal of the terminal strip.

14. To connect the 12...35 V DC power supply through the cable glands, refer to chapter [8.13](#).

15. To connect the outputs, refer to chapter [8.14](#) and chapter [8.15](#).

16. Connect the functional earth conductor. See chapter [8.12](#).

17. If the display module or the Wi-Fi module is removed, connect it back.

18. Close the front and the top of the transmitter housing.

Fig. 29: Wiring the device through the M20x1.5 cable glands in nickel plated brass

8.12 Connecting the functional earth (device variant with two M20x1.5 cable glands)

- For a proper function of device always connect the yellow/green functional earth conductor:
- either to the functional earth plate in the transmitter housing (see [Fig. 31](#) in chapter 8.13),
 - or to the functional earth screw on the outer surface of the transmitter housing (see [Fig. 30](#)).

If you connect the conductor to the functional earth screw:

- Use a ring cable lug for M4 screw.
- Tighten the M4 screw to a torque between 1.8...2 Nm (1.3...1.4 ft·lbf).

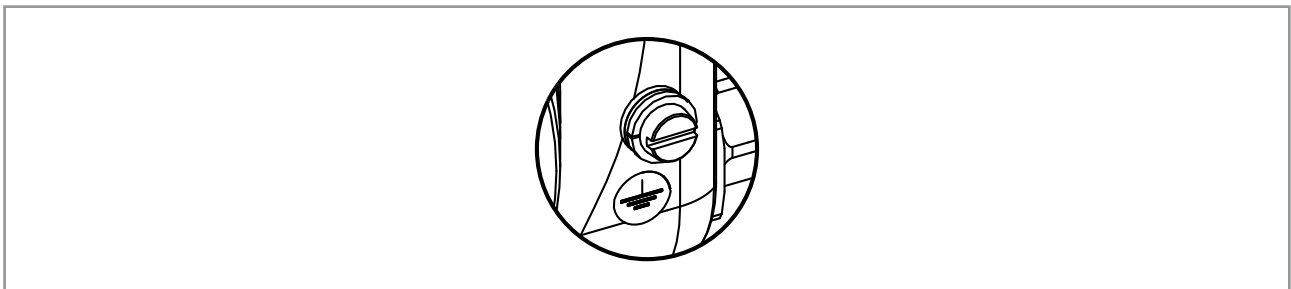

Fig. 30: Functional earth screw on the outer surface of the device

8.13 Connecting the device to a 12...35 V DC power supply through the M20x1.5 cable glands (device variant with cable glands)

1. Use a 3.0 mm slot screwdriver (any length) and a force of max. 40 N to push the terminal 5 and disconnect the white conductor. Do not cut the white conductor.
2. Insulate the white conductor.
3. Connect the power supply as shown in [Fig. 31](#).

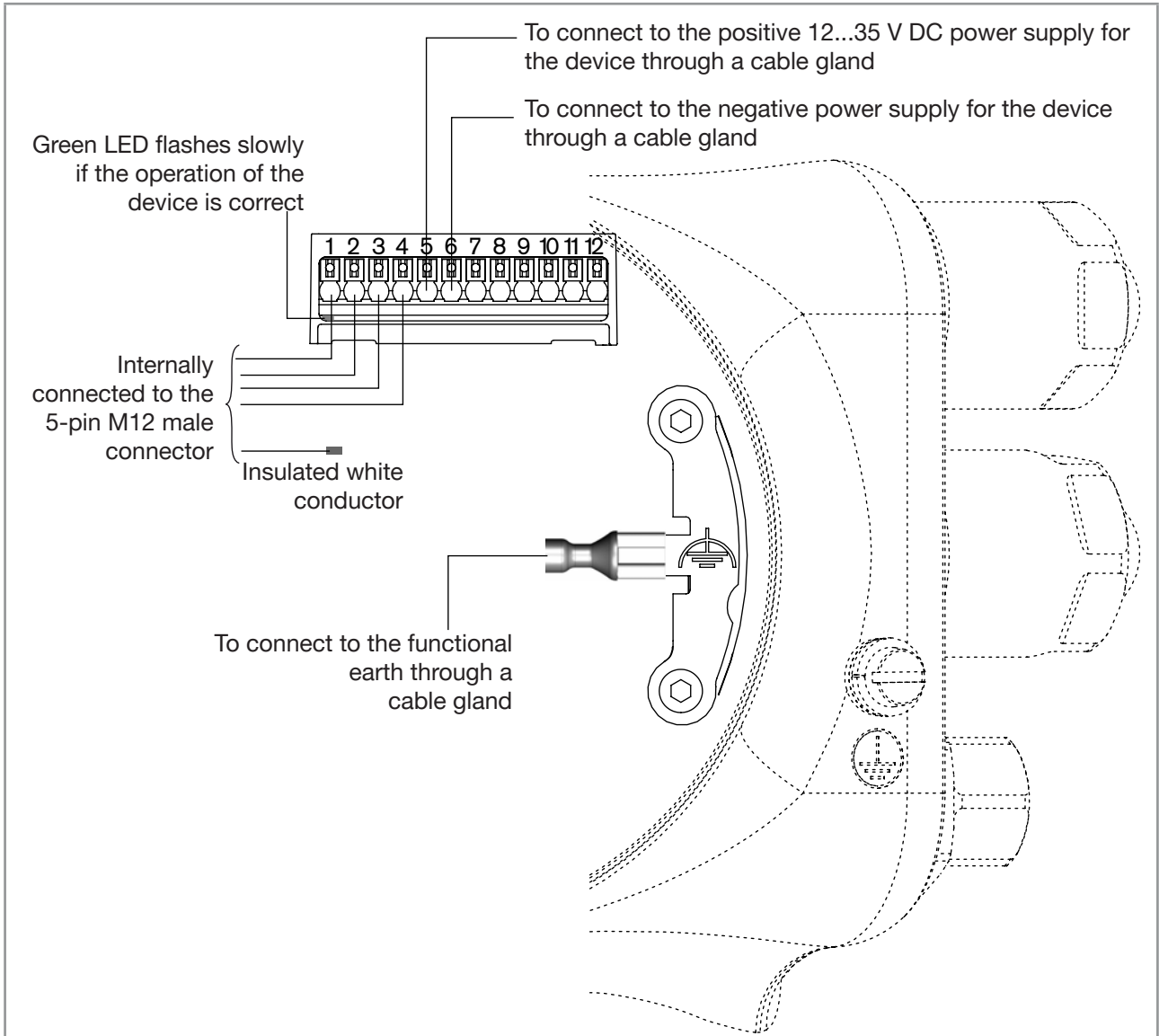

Fig. 31: Connecting the 12...35 V DC power supply through the M20x1.5 cable glands

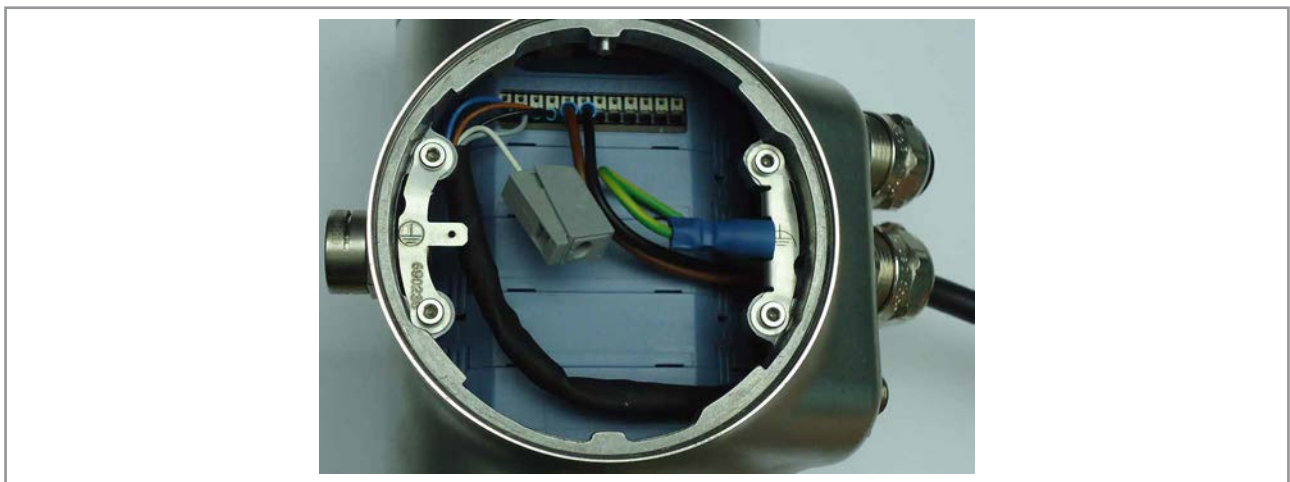

Fig. 32: Device connected to a 12...35 V DC power supply through the M20x1.5 cable glands

8.14 Wiring output 1 (analogue) and output 3 configured as an analogue output (device variant with cable glands)

NOTICE

Risk of short-circuit if the configuration of output 3 is wrong.

- Before wiring output 3 as an analogue output, make sure output 3 is configured as an analogue output in the Parameter menu of the outputs. See chapter [18.2 Changing the type of output 3](#).

An analogue output can be wired either in sourcing mode or in sinking mode.

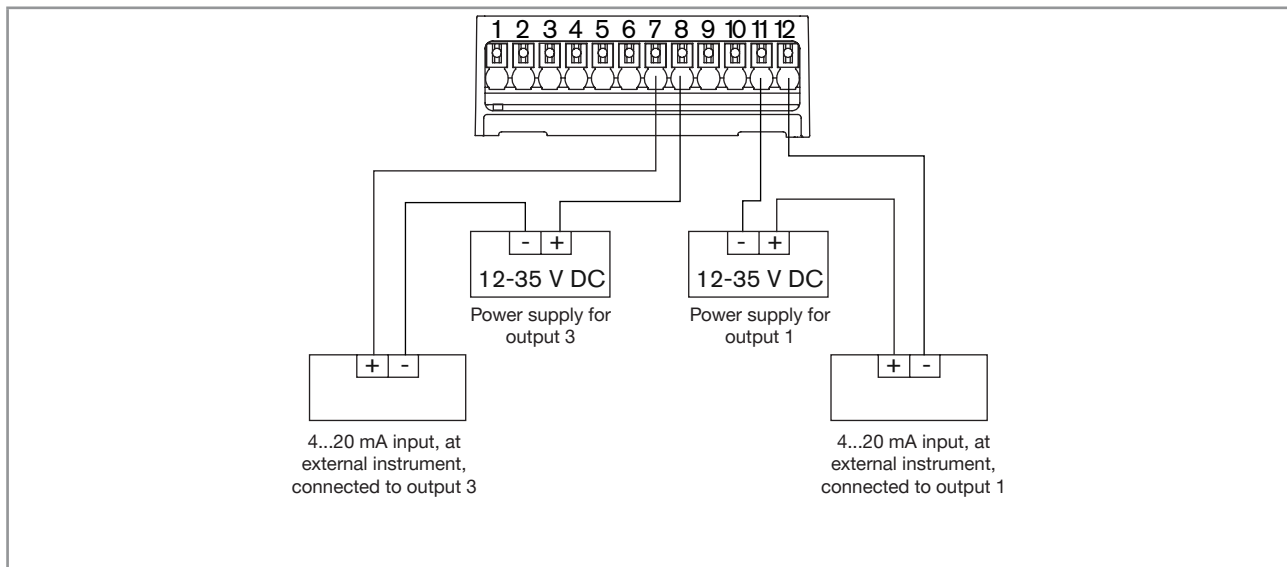

Fig. 33: Wiring the analogue outputs

8.15 Wiring output 2 (digital) and output 3 configured as a digital output (device variant with cable glands)

NOTICE

Risk of short-circuit if the configuration of output 3 is wrong.

- Before wiring output 3 as a digital output, make sure output 3 is configured as a digital output in the Parameter menu of the outputs. See chapter [18.2 Changing the type of output 3](#).

A digital output can be wired either in NPN mode or in PNP mode.

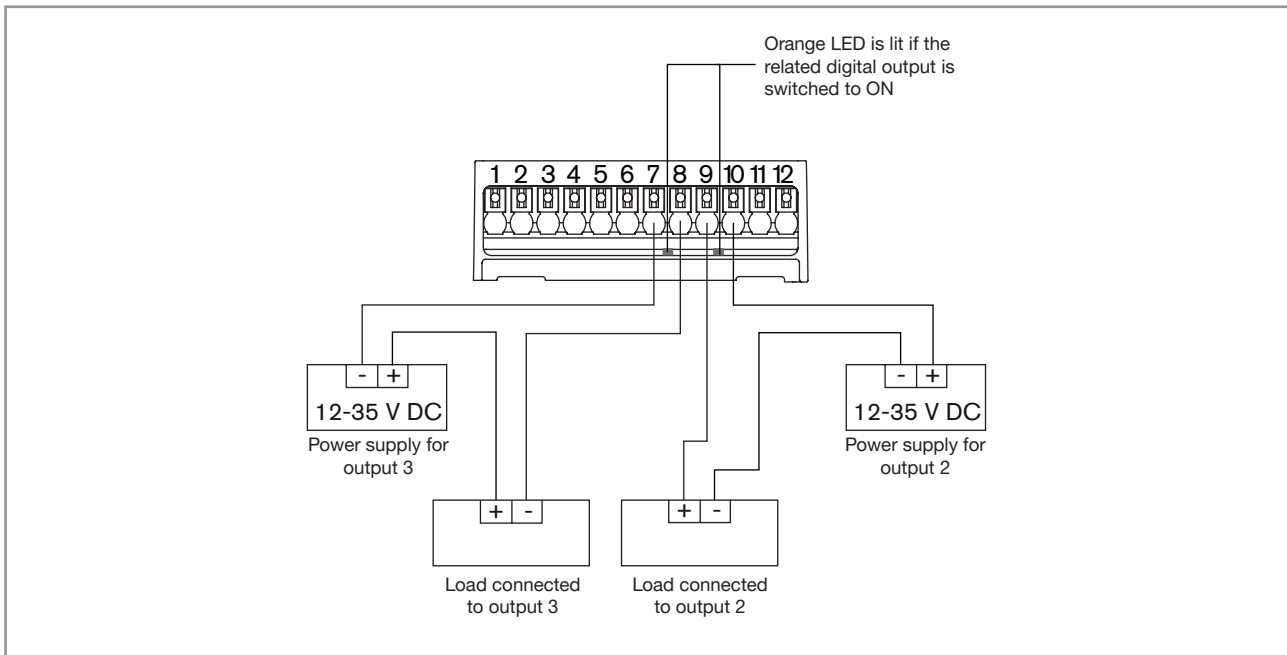

Fig. 34: Wiring the digital outputs

8.16 Knowing the status of the Ethernet network (device variant with two 4-pin M12 female connectors - Ethernet device variant)

The status of the Ethernet network is indicated by LEDs. The LEDs are located on the industrial communication module in the transmitter housing.

→ To see the LEDs, open the front of the transmitter housing by removing either the blind cover or the display module or the Wi-Fi module; see chapter 8.9.

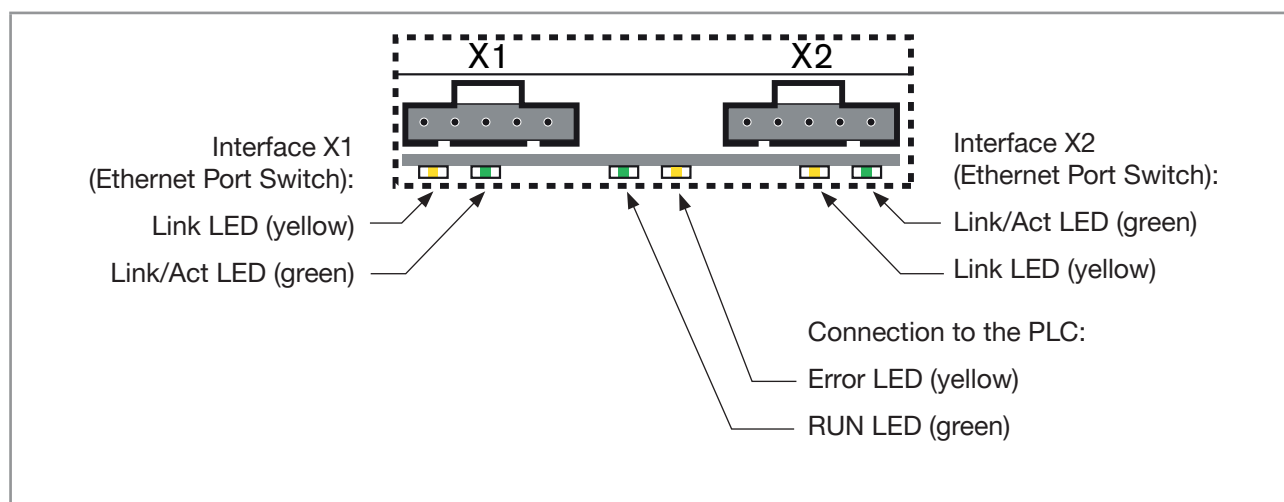

Fig. 35: Status LEDs for the industrial communication module

Description of the LEDs:

Table 17: Status LED for the connection to the PLC

LED status		Connection status	What to do?
RUN LED (green)	Error LED (yellow)		
ON	OFF	Connection active.	-
OFF	ON	Connection not active.	Check cables

Table 18: Status LEDs for the connection to the Ethernet network

LED status		Connection status	What to do?
Link/Act LED (green)	ON		
	OFF	No connection to the network is available.	Check cables
Link LED (yellow)	ON	Connection to the network is available.	-
	OFF	No connection to the network is available.	Check cables

8.17 Specifications of the cables and conductors for the 4-pin M12 female connectors

Table 19: Specifications of the cables and conductors for the 4-pin M12 female connectors

Specification of the cables and conductors	Recommended value
Electromagnetic protection (EMC)	Shielded conductor with minimum STP
Minimum category	CAT-5
Maximum length	100 m
Maximum operating temperature	80 °C or higher

8.18 Connecting the device to an Ethernet network (device variant with two 4-pin M12 female connectors – Ethernet device variant)

The two 4-pin M12 female connectors (D-coding) are used to connect the device to an Ethernet network.



Risk of damage to the device if any M12 connector is unused.

- ▶ Put a screwed plug on all the unused M12 connectors. Screw the plug of the 4-pin M12 female connector to a torque of 1.3 Nm (0.96 ft-lbf).



If a device with two 4-pin M12 female connectors (Ethernet device variant) is connected to an Ethernet network, you must connect it to a bÜS / CANopen network for the configuration of the device with the software Bürkert Communicator.

If a device is connected to an Ethernet network, the measured process values are transmitted via the Ethernet network.

Each 4-pin M12 female connector (D-coding) has the same pin assignment: See Fig. 36.



Fig. 36: Pin assignment of the 4-pin M12 female connector

→ Loosen the screwed plug of the 4-pin M12 female connector and store the screwed plug in a safe and clean place.

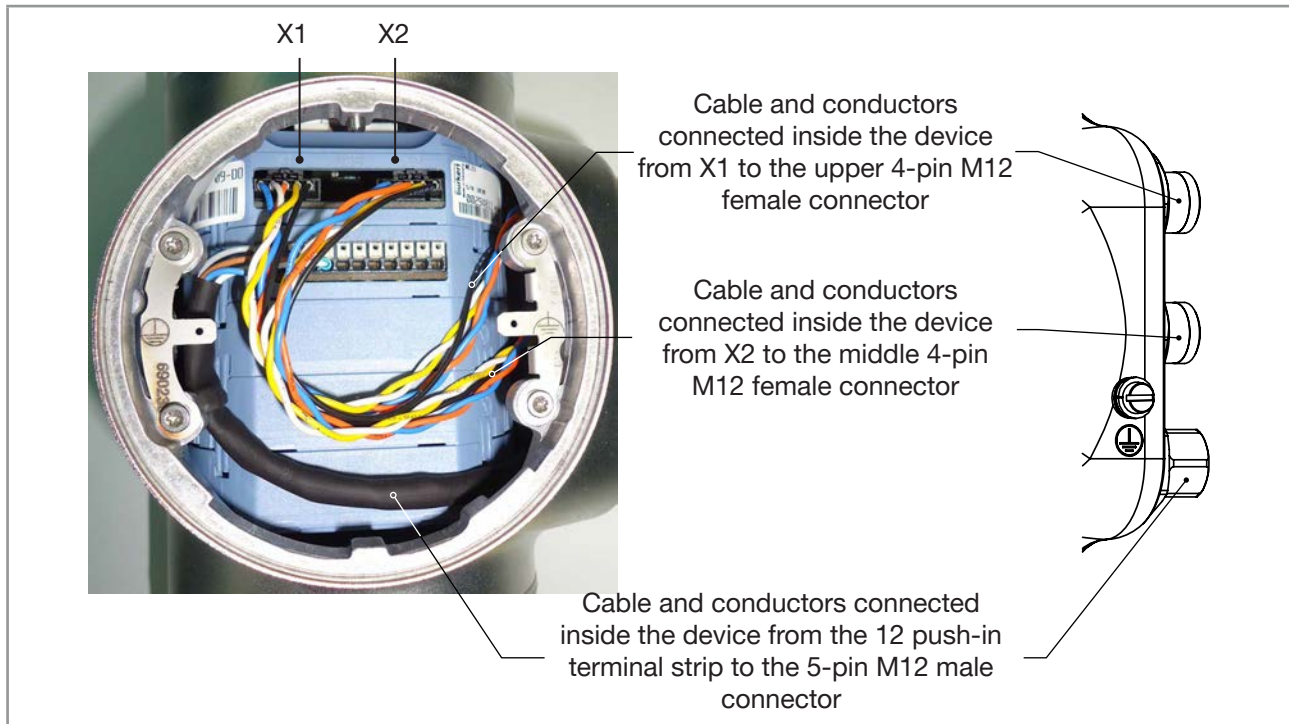

Fig. 37: Wiring ex works of the device with two 4-pin M12 female connectors (Ethernet device variant)

8.19 Connecting the functional earth (device variant with two 4-pin M12 female connectors - Ethernet device variant)

For a proper function of device always connect the yellow/green functional earth conductor to the functional earth screw on the outer surface of the transmitter housing.

→ Use a ring cable lug for M4 screw.

→ Connect the functional earth conductor to the functional earth screw, see [Fig. 38](#).

→ Tighten the M4 screw to a torque between 1.8...2 Nm (1.3...1.4 ft·lbf).

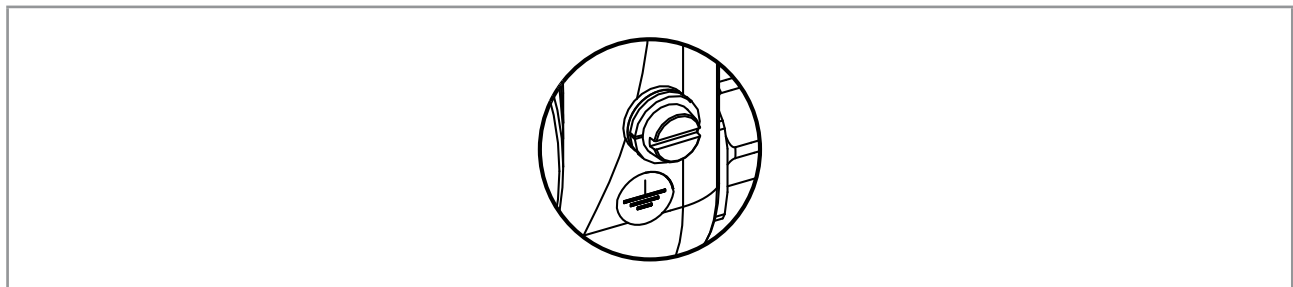

Fig. 38: Functional earth screw on the outer surface of the device

Commissioning

9	COMMISSIONING	74
9.1	Safety instructions	74
9.2	Prerequisites	74
9.3	First commissioning for measuring the flow rate or for filling containers	74
9.4	First commissioning for detecting a change of liquid in the pipe	76
9.5	First commissioning for detecting bubbles in the pipe	77

9 COMMISSIONING

9.1 Safety instructions



WARNING

Risk of injury due to non-conforming commissioning.

Non-conforming commissioning could lead to injuries and damage the device and its surroundings.

- ▶ Before commissioning, make sure that the staff in charge have read and fully understood the contents of the operating instructions.
- ▶ In particular, observe the safety recommendations and intended use.
- ▶ The device and the installation must only be commissioned by suitably trained staff.

9.2 Prerequisites

- The device is installed into the pipe.
- The electrical installation of the device is performed. The device is correctly connected to the functional earth.
- If your liquid is not water, then make sure that the optional features DF measurement and acoustic transmission factor measurement are activated.

9.3 First commissioning for measuring the flow rate or for filling containers

1. Energise the device.
2. Connect the device to the Bürkert Communicator software. Print a pdf report of all the current settings of the device. Select the process values that you want to monitor graphically. Refer to the Type 8920 Bürkert Communicator software from country.burkert.com.
3. On the display module, do the settings of the **Quick start** menu. Refer to chapter [11.2](#).
4. Make sure that the liquid to process is inside the device.
5. If the liquid is not water, then read out the value of the parameter **Acoustic transmission factor**. Refer to chapter [15.13](#).
 - If the value is higher than 20 % ±5 %, then the flow rate of the liquid can be measured by the device.
 - If the value is lower than 20 % ±5 %, then the flow rate of the liquid might not be measured accurately by the device.
6. If the liquid is not water, then read out the value of the parameter **DF**. Refer to chapter [15.12](#).
 - If the value is between 0.8 and 1.2, then the flow rate of the liquid can be measured by the device.
 - If the value is lower than 0.8 or higher than 1.2, then the flow rate of the liquid might not be measured accurately by the device.

7. Set the parameter **Viscosity compensation** for the liquid:
 - If the liquid is water, then make sure that the parameter **Viscosity compensation** is set to **water**. Refer to chapter [15.15](#).
 - If the liquid has a kinematic viscosity that is between 0.5 and 2 mm²/s, then you can keep the parameter **Viscosity compensation** to **water**. Refer to chapter [15.15](#).
 - If the liquid is not water or if the liquid kinematic viscosity is lower than 0.5 or higher than 2 mm²/s, then set the parameter **Viscosity compensation** to a value that is adapted to the liquid properties and to the process conditions. Refer to chapter [15.15](#).
8. Set the parameter **Refresh time** to **Short**. Refer to chapter [15.16](#).
9. To monitor the volume flow rate, set the parameter **Damping** of the volume flow rate:
 - To measure a stable volume flow rate or to conduct a teach-in procedure depending on the volume flow rate **Teach-in by volume flow**, set the parameter **Damping** of the volume flow rate to **Medium**. Refer to chapter [15.4.2](#) or [15.4.3](#).
 - To fill containers on a time scale typically ≥ 30 s, set an appropriate damping of the volume flow rate. Refer to chapter [15.4.2](#), [15.4.3](#) or [15.4.4](#).
 - To fill containers on a time scale typically < 30 s or to conduct a **Teach-in by volume**, set the parameter **Damping** of volume flow rate to **None**. Refer to chapter [15.4.4](#).
10. To monitor the mass flow rate, set the parameter **Damping** of the mass flow rate:
 - To measure a stable mass flow rate or to conduct a teach-in procedure depending on the mass flow rate **Teach-in by mass flow rate**, set the parameter **Damping** of the mass flow rate to **Medium**. Refer to chapter [15.5.2](#) or [15.5.3](#). Set the parameter **Damping** of the density to **Medium**. Refer to chapter [15.9.4](#).
 - To fill containers on a time scale typically ≥ 30 s, set an appropriate damping of the mass flow rate. Refer to chapter [15.5.2](#), [15.5.3](#) or [15.5.4](#). Set the parameter **Damping** of the density to **None**. Refer to chapter [15.9.4](#).
 - To fill containers on a time scale typically < 30 s or to conduct a **Teach-in by mass**, set the parameter **Damping** of mass flow rate to **None**. Refer to chapter [15.5.4](#). Set the parameter **Damping** of the density to **None**. Refer to chapter [15.9.4](#).
11. To monitor the volume flow rate, make sure that the volume flow **Cut-off** function is active and set the **Cut-off** value. Refer to chapter [15.4.9](#) or [15.4.10](#).
12. To monitor the mass flow rate, make sure that the mass flow **Cut-off** function is active and set the **Cut-off** value. Refer to chapter [15.5.9](#) or [15.5.10](#).
13. To monitor the mass flow rate, calibrate **Density** by either using a teach-in procedure, either setting offset and slope value of density. Refer to chapter [17.19](#).
14. Set the parameter **K factor**. Refer to chapter [17.7](#). The K factor applies to both process values volume flow rate and mass flow rate.
15. There can be negative flows at the start or end of a batching step. By default, the counting directions of the volume totalizers and mass totalizers and of the pulse outputs are set to **Positive only** and will not take backwards flows into account. If necessary, depending on the rest of the batching system, set the counting directions to **Both directions**. Refer to chapter [15.8.2](#) for volume totalizer, refer to chapter [18.5.4](#) for pulse output, refer to chapter [15.11.2](#) for mass totalizer.
16. Check the correct behaviour of the device by using the menu **Simulation**. Refer to chapter [17.27](#).

17. With the Bürkert Communicator software, print a pdf report of the new settings of the device.
18. Select the process values that you want to save and export the selected data under the format (*.edipdb). Refer to the Type 8920 Operating Instruction.
19. Disconnect the Bürkert Communicator software from the device.

9.4 First commissioning for detecting a change of liquid in the pipe

1. Energise the device.
2. Connect the device to the Bürkert Communicator software. Print a pdf report of all the current settings of the device. Select the process values that you want to monitor graphically. Refer to the Type 8920 Bürkert Communicator software from country.burkert.com.
3. On the display module, do the settings of the **Quick start** menu. Refer to chapter [11.2](#).
4. If the liquid is not water, then read out the value of the **Acoustic transmission factor**. Refer to chapter [15.13](#).
 - If the value is higher than 20 % \pm 5 %, then the flow rate of the liquid can be measured by the device.
 - If the value is lower than 20 % \pm 5 %, then the flow rate of the liquid might not be measured accurately by the device.
5. If the liquid is not water, then read out the value of the **DF**. Refer to chapter [15.12](#).
 - If the value is between 0.8 and 1.2, then the flow rate of the liquid can be measured by the device.
 - If the value is lower than 0.8 or higher than 1.2, then the flow rate of the liquid might not be measured accurately by the device.
6. Adjust the parameter **Damping** of the acoustic transmission factor, depending on your application. Refer to chapter [15.13.3](#) or [15.13.4](#).
7. Adjust the parameter **Damping** of the DF, depending on your application. Refer to chapter [15.12.3](#) or [15.12.4](#).
8. Check the correct behaviour of the device by using the menu **Simulation**. Refer to chapter [17.27](#).
9. With the Bürkert Communicator software, print a pdf report of the new settings of the device.
10. Select the process values that you want to save and export the selected data under the format (*.edipdb). Refer to the Type 8920 Operating Instruction.
11. Disconnect the Bürkert Communicator software from the device.

9.5 First commissioning for detecting bubbles in the pipe

1. Energise the device.
2. Connect the device to the Bürkert Communicator software. Print a pdf report of all the current settings of the device. Select the process values that you want to monitor graphically. Refer to the Type 8920 Bürkert Communicator software from country.burkert.com.
3. On the display module, do the settings of the **Quick start** menu. Refer to chapter [11.2](#).
4. If the liquid is not water, then read out the value of the **Acoustic transmission factor**. Refer to chapter [15.13](#).
 - If the value is higher than 20 % \pm 5 %, then the flow rate of the liquid can be measured by the device. Refer to chapter [15.12](#).
 - If the value is lower than 20 % \pm 5 %, then the flow rate of the liquid might not be measured accurately by the device.
5. If the liquid is not water, then read out the value of the **DF**. Refer to chapter [15.12](#).
 - If the value is between 0.8 and 1.2, then the flow rate of the liquid can be measured by the device.
 - If the value is lower than 0.8 or higher than 1.2, then the flow rate of the liquid might not be measured accurately by the device.
6. Adjust the parameter **Damping** of the acoustic transmission factor, depending on your application. Refer to chapter [15.12.3](#) or [15.12.4](#).
7. Check the correct behaviour of the device by using the menu **Simulation**. Refer to chapter [17.27](#).
8. With the Bürkert Communicator software, print a pdf report of the new settings of the device.
9. Select the process values that you want to save and export the selected data under the format (*.edipdb). Refer to the Type 8920 Operating Instruction.
10. Disconnect the Bürkert Communicator software from the device.

Doing the settings

- 10 HOW TO DO THE SETTINGS 80
 - 10.1 Safety instructions 80
 - 10.2 Available software to do the settings..... 80
 - 10.3 Connect the device to the Bürkert Communicator software 80
 - 10.4 Display module: description of the user interface..... 82
 - 10.4.1 Description of the display 83
 - 10.4.2 How to use the touch sensitive keys 84
 - 10.4.3 Minimum and maximum values when entering a numerical value..... 84
 - 10.5 Available login user levels 84
 - 10.6 Default settings 85
 - 10.7 Menu structure 86
 - 10.7.1 Opening or closing the context menu in any view (display module only) 87
 - 10.7.2 Adding your own context menu items (shortcuts, display module only) 88
 - 10.7.3 Reading out the messages generated by the device 89
 - 10.7.4 Changing the login user level if the adjustment is not protected through passwords..... 89
 - 10.7.5 Changing the login user level if the adjustment is protected through passwords . 90
 - 10.7.6 Logging out from the **Advanced user**, **Installer** or **Bürkert** user level..... 90
 - 10.7.7 Reading out the access path to a menu item (display module only) 91
 - 10.8 How to navigate in the menus and to adjust values 91
 - 10.8.1 Adjusting a percentage or selecting a value in a list 91
 - 10.8.2 Navigating in a wizard and adjusting numbers 92
 - 10.8.3 Setting negative or positive numbers 93
 - 10.8.4 Entering a name..... 94
 - 10.8.5 Activating or deactivating a feature..... 95

MAN 1000273158 EN Version: M Status: RL (released | freigegeben) printed: 22.06.2022

10 HOW TO DO THE SETTINGS

10.1 Safety instructions



WARNING

Risk of injury due to non-conforming adjustment.

Non-conforming adjustment could lead to injury and damage the device and its surroundings.

- ▶ The operators in charge of adjustment must have read and understood the contents of the Operating Instructions.
- ▶ In particular, observe the safety recommendations and intended use.
- ▶ The device/installation must only be adjusted by suitably trained staff.

10.2 Available software to do the settings

The settings of the device can be done with:

- the Type ME31 display module. The device can be equipped with a display module or not.
- the Type 8920 Bürkert Communicator software, which must be installed on a PC.

The menu structure is the same in the display module and in the Bürkert Communicator software.

- To do the settings of the device with the Type ME31 display module, refer to the next chapters of these Operating Instructions, starting with chapter [10.4 Display module: description of the user interface](#).
- To use the Bürkert Communicator software, first prepare the necessary hardware and the software. Refer to chapter [10.3](#). Then do the settings as described in these Operating Instructions, starting with chapter [10.4.3 Minimum and maximum values when entering a numerical value](#).
- To use some specific functions that are only available with the Bürkert Communicator software, refer to the Type 8920 Operating Instructions, available on the internet at country.burkert.com.
- To get detailed information on the software of the Type ME31 display module, refer to the related Operating Instructions, available on the internet at country.burkert.com.

10.3 Connect the device to the Bürkert Communicator software

To do the settings with the Type 8920 Bürkert Communicator software, do the following steps:

1. Buy the USB-büS interface set with article number 772426 from Bürkert.
2. Download the latest version of the Type 8920 Bürkert Communicator software from country.burkert.com.
3. Install the Bürkert Communicator software on a PC. Obey the installation recommendations given in the USB-büS interface set. During installation, the büS stick must not be inserted at the PC.
4. Screw the termination resistance into the Y plug or activate the device internal termination resistor (see chapter [12.6.3](#)).
5. Screw the female M12 connector at the end of the delivered cable into the Y plug.

6. Insert the mini-USB of the cable into the delivered büS stick.
Do not insert the mini-USB of the cable into any equipment other than the büS stick.
7. Insert the appropriate power adapter into the AC/DC adapter.
8. Connect the cable of the AC/DC adapter to the related connector of the female M12 connector.

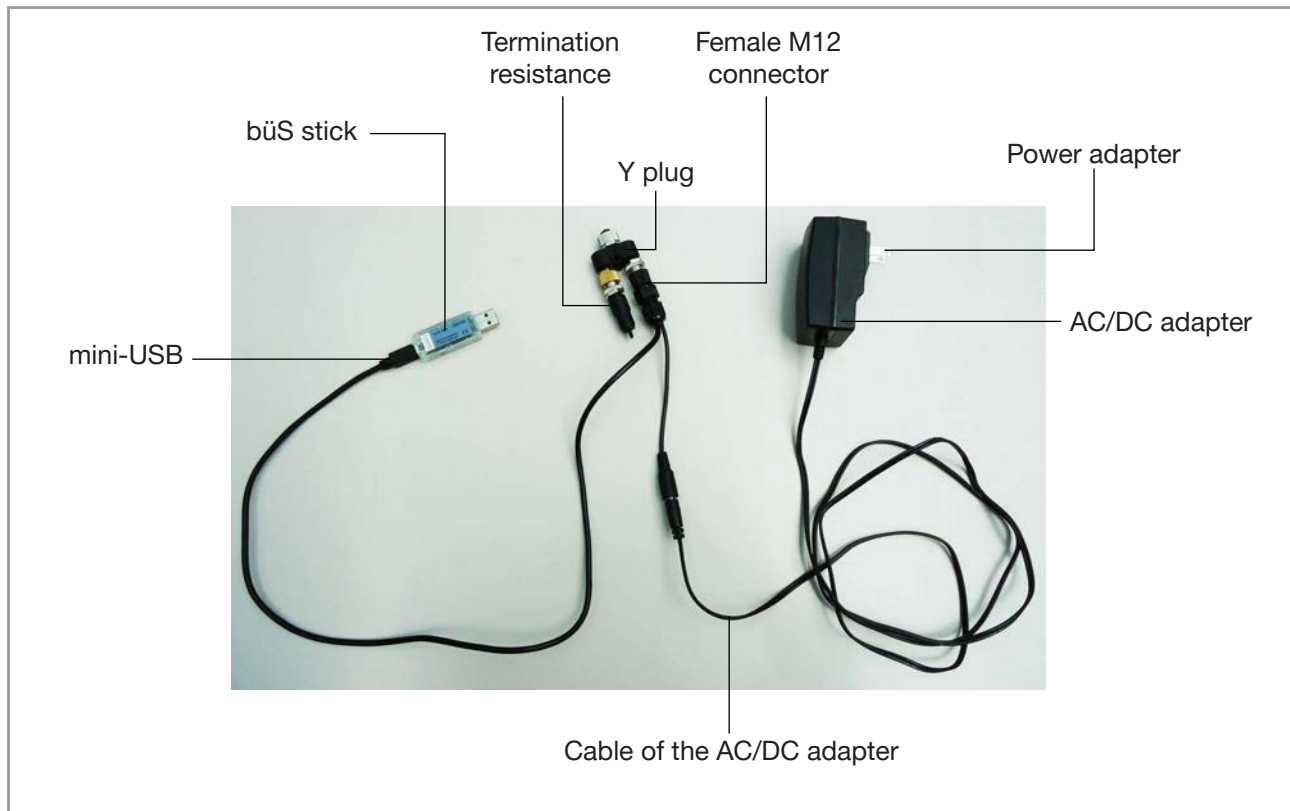



Fig. 39: Assembled connection cables, plugs and büS stick

9. Screw the Y plug on the male M12 connector of the device.
10. Insert the büS stick into a USB port of the PC.
11. Wait until the Windows pilot of the büS stick has been completely installed on the PC.
12. Connect the AC/DC adapter to the power supply.
13. Start the Bürkert Communicator software.
14. Click on  in the Bürkert Communicator software to establish the communication between the Bürkert Communicator software and the device. A window opens.
15. Select **büS-Stick**.
16. Choose the port **Bürkert büS Stick**, click on **Finish** and wait until the device symbol appears in the list of devices.
17. In the list of devices, click on the symbol related to the device. The menu structure for the device is displayed.

10.4 Display module: description of the user interface



To get detailed information on the display software, refer to the Operating Instructions of the Type ME31 display software, available on the internet at country.burkert.com.

The user interface is made up of a display and touch sensitive keys.

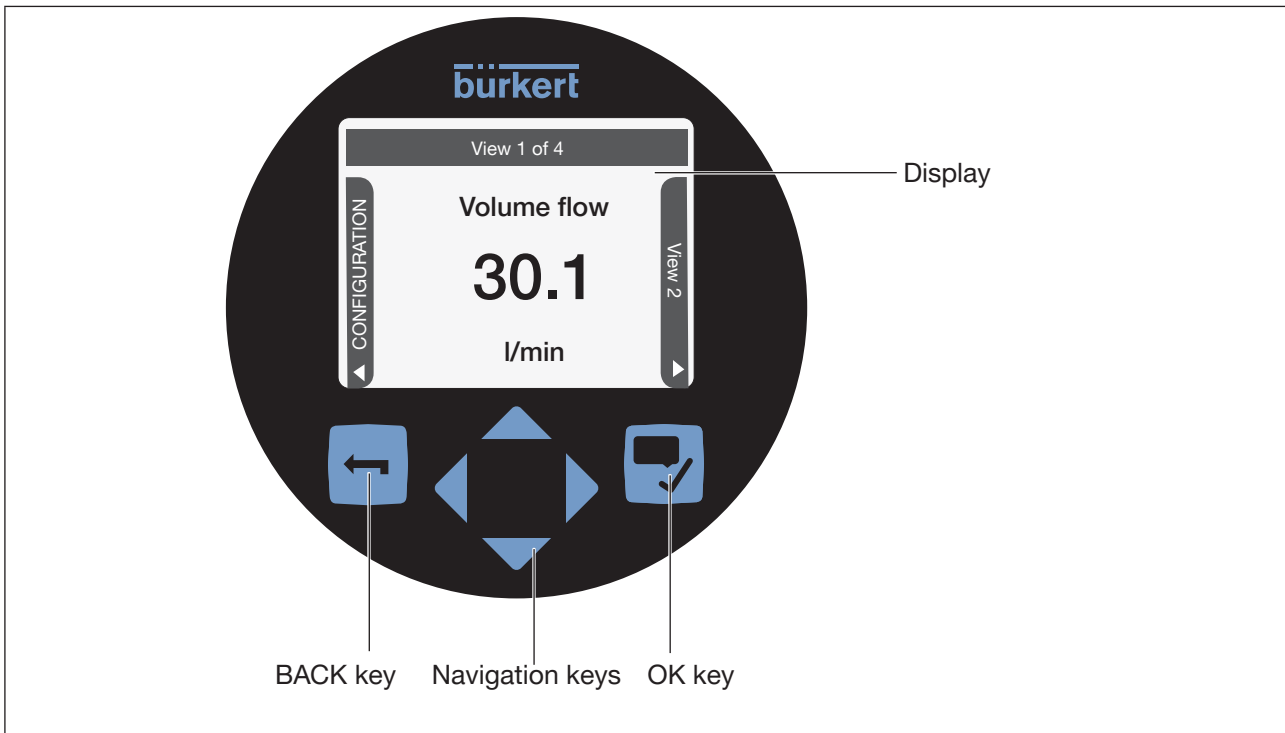

Fig. 40: Overview of the user interface

10.4.1 Description of the display

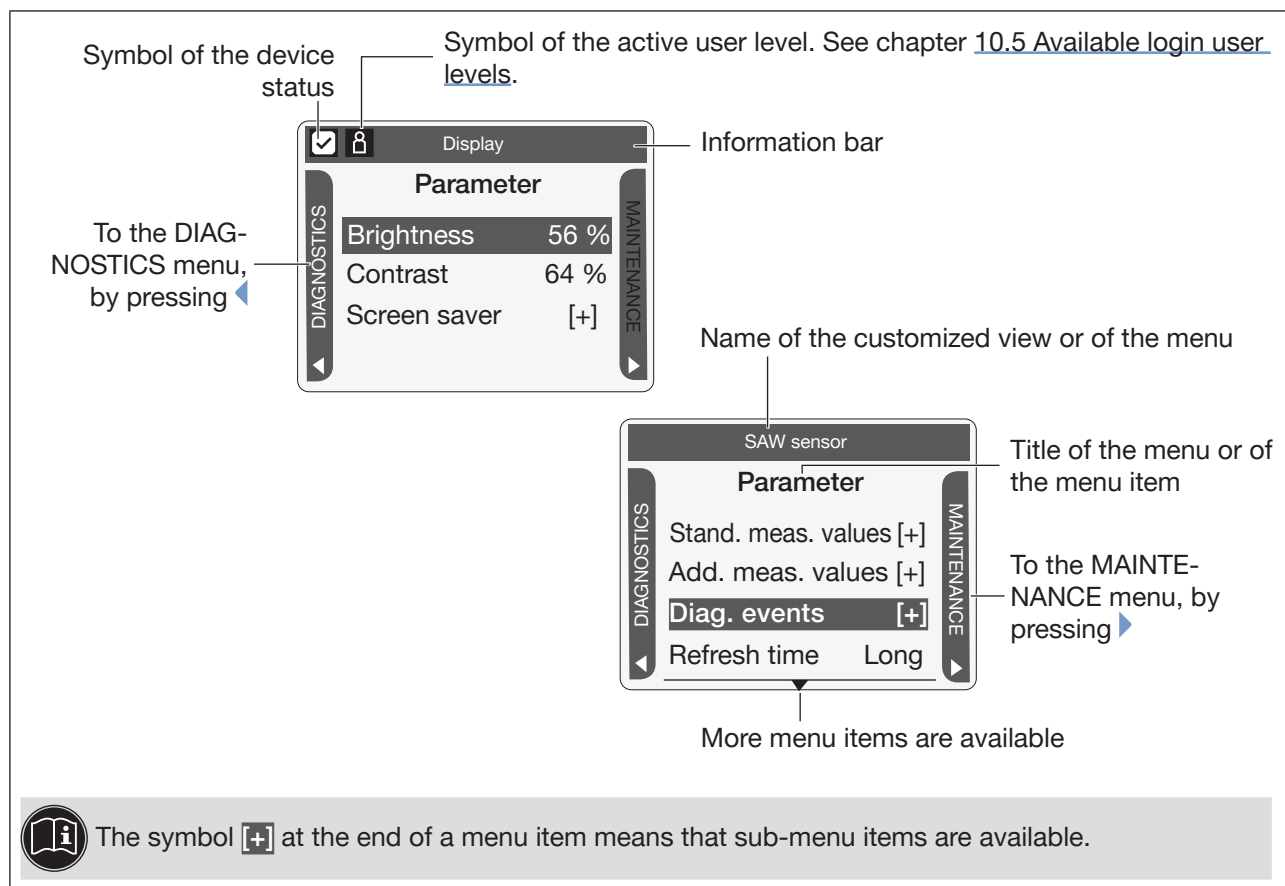

Fig. 41: Description of the display (examples)

10.4.2 How to use the touch sensitive keys





 The **highlighted terms** are related to menus or menu items.

Table 20: How to use the keys

Key	Description
	<p>Short press: to go back to the parent menu or to the parent view. This key is called BACK in the display messages.</p> <p>If the user makes changes but does not save these, then a message is displayed asking if the changes should be saved.</p> <p>Long press: to go back to View 1</p>
	<p>If one or both keys are displayed:</p> <ul style="list-style-type: none"> To switch between views, from the left to the right and vice versa. Only possible between the views that can be customized and the CONFIGURATION view, and between the Diagnostics, Parameter and Maintenance views. To select the digit to the left or the digit to the right when you are asked to enter a value.
	<ul style="list-style-type: none"> To select a Menu item. To select an option or to change a value.
	<p>This key is called OK in the display messages.</p> <p>Short press:</p> <ul style="list-style-type: none"> To confirm a selection. To save a choice. To go to the next screen of the wizard. <p>Long press: to open the context menu</p>

10.4.3 Minimum and maximum values when entering a numerical value

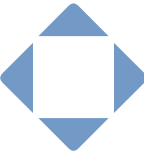
When you are requested to enter or to change a numerical value, the minimum and maximum authorized values are always displayed.

10.5 Available login user levels





The following 4 login user levels are available to operate or adjust the device:

- the basic user level, which is the level with the least functions,
- the **Advanced User** user level,
- the **Installer** user level (default),
- the **Bürkert** user level.

By default, the device adjustment is not protected by passwords.

Table 21 shows the symbol displayed in the information bar, depending on the user level that is active on the device, and what can be done with each type of user level.

Table 21: Possible login user levels

Symbol ¹⁾	User level	Description
No symbol	Basic user	<ul style="list-style-type: none"> No password is required. The menu items with the symbol  enable read-only access. Not all the menu items that are available with a higher user level are displayed.
	Advanced user	<ul style="list-style-type: none"> Password required, if the password protection is active (see chapter 12.15). Default password is 005678. The menu items with the symbol  enable read-only access. Not all the menu items that are available with a higher user level are displayed.
	Installer	<ul style="list-style-type: none"> Password required, if the password protection is active (see chapter 12.15). Default password is 001946. This level is active by default (and by default, password protection is switched off). All the available menu items can be adjusted.
	Bürkert	<ul style="list-style-type: none"> Password required, if the password protection is active (see chapter 12.15). Only for Bürkert service.

¹⁾ displayed in the information bar, only if the adjustment is protected through passwords.

→ If you have forgotten your passwords, you can restore the default passwords with the Type 8920 Bürkert Communicator software. Refer to the related Operating Instructions.

10.6 Default settings

You can find the default settings of the device in the CANopen supplement for the Type 8098 FLOWave L at country.burkert.com.

→ Before making any changes to the settings, use the Bürkert Communicator software to print a pdf file with all the default settings of the device.

10.7 Menu structure

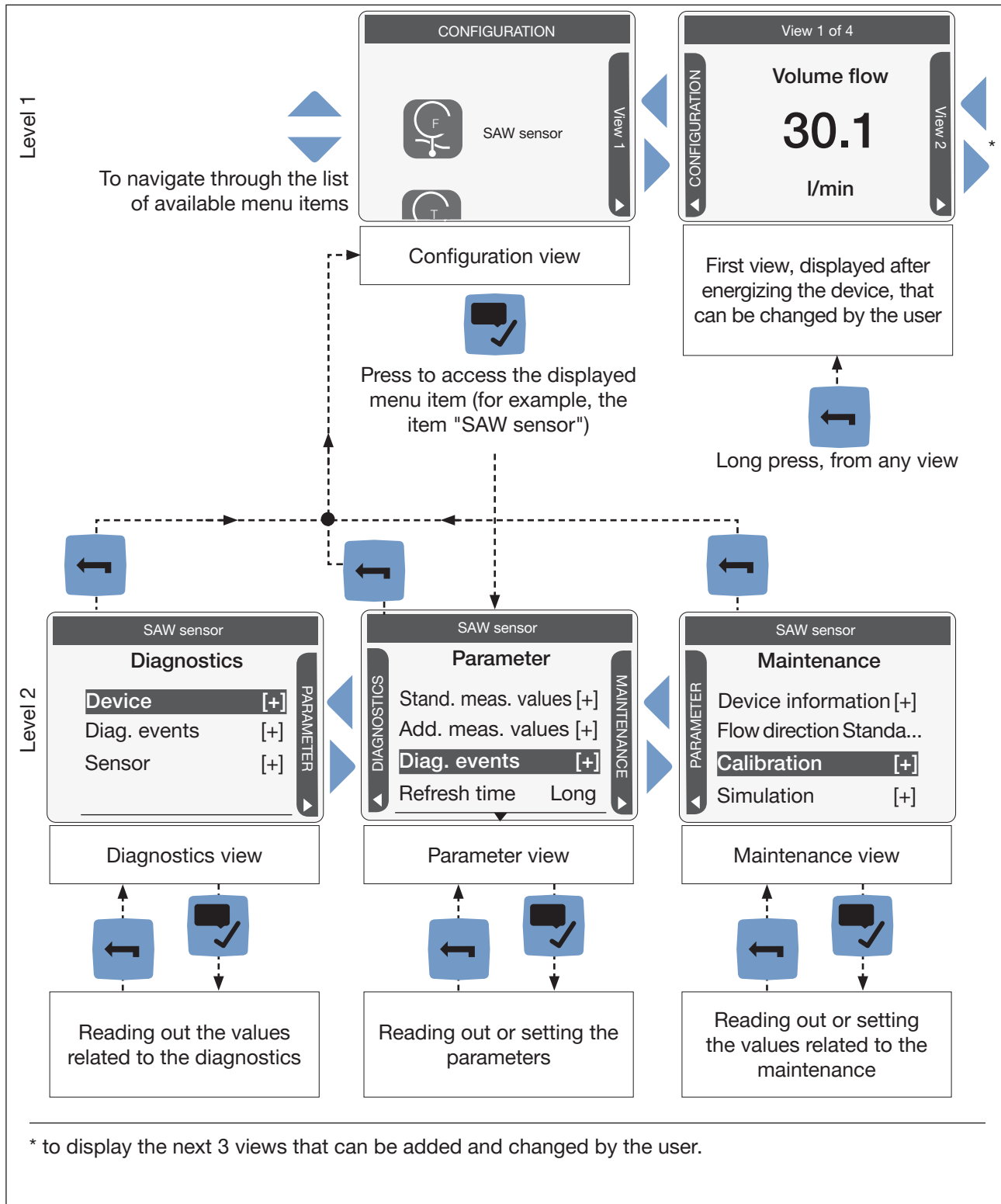

Fig. 42: Menu structure of the FLOWave

A context menu can be opened in any view: see chapter [10.7.1](#).

10.7.1 Opening or closing the context menu in any view (display module only)

The user can open a context menu in any view. The content depends on the active view.

To open the context menu:

→ Press and hold .

✔ The context menu is open.

To close the context menu without leaving the active view:

→ Press .

✔ The context menu is closed.

Context menu content depending on the view:

Table 22: Context menu depending on the view

View	Menu items of the context menu	
Views 1 to 4	Messages overview	To display the list of messages generated by the device. See chapter 10.7.3 .
	Add new view	To add a new view or to delete the displayed view.
	Delete this view	
	Change layout	To choose to display 1, 2 or 4 values or a trend of 1 or 2 values.
	Change title	To change the title of the displayed view.
	Change value	To change the value(s) or the units of the values displayed in the view.
	Change unit	
	Fractional digits	Not available for trends.
Change user level	To choose whether a value of the view is displayed as a whole number or with one or more decimals.	
CONFIGURATION	Change user level	To change the user level. See chapter 10.7.4 or chapter 10.7.5 .
	Messages overview	To display the list of messages generated by the device.
Parameter Maintenance Diagnostics	Change user level	To change the user level.
	Messages overview	To display the list of messages generated by the device.
	Where am I?	To display the access path to the displayed menu item. See chapter 10.7.7 .
	Add shortcut	To create or delete your own context menu items (see chapter 10.7.2).
	Delete shortcut	
Change user level	To change the user level.	

View	Menu items of the context menu	
in a menu	Messages overview	To display the list of messages generated by the device.
	Save	To save the changes.
	Where am I?	To display the access path to the displayed menu item. Not available in the wizard.
	Add shortcut	To create or delete your own context menu items (see chapter 10.7.2).
	Delete shortcut	
	Change user level	To change the user level.

10.7.2 Adding your own context menu items (shortcuts, display module only)

If you are in the **Parameter**, **Maintenance** or **Diagnostics** view or in a menu, you can add up to 3 shortcuts to the context menu. These shortcuts then appear in every context menu and allow the user to jump directly to the selected view or menu item.

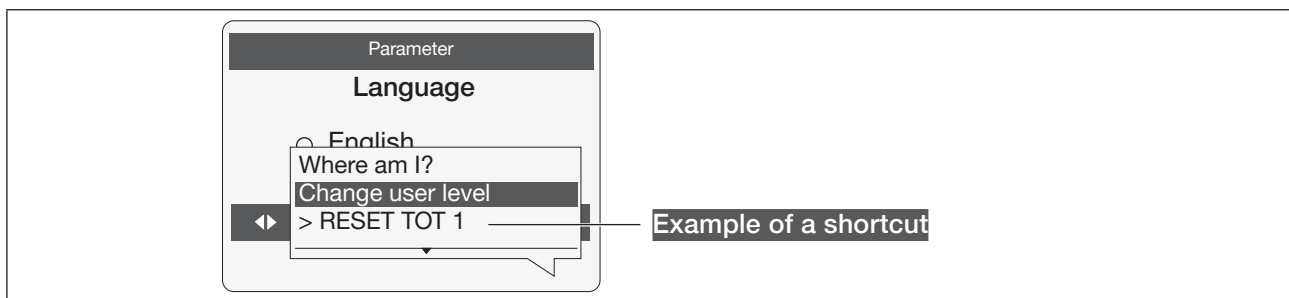









Fig. 43: Shortcut example

To add a shortcut to the context menu:

- Go to the view or menu for which a shortcut should be created.
- Press and hold  to open the context menu.
-  **Add shortcut**
- Enter a name for this shortcut: see chapter 10.8.4 [Entering a name](#).
-  **OK** to confirm the name entered. ----->  **Save**.

✓ The shortcut to this view or to this menu is added to the context menu.

To delete a shortcut from the context menu:

- Press and hold  to open the context menu.
- By using the shortcut to be deleted, go to the view or menu item.
- Press and hold  to open the context menu.
-  **Delete shortcut** -----  Confirm.



 The shortcut to this view or to this menu item is deleted from the context menu.

10.7.3 Reading out the messages generated by the device

The device generates messages to inform you, for example, that a problem has occurred or that a process value limit has been reached.

- To read out the messages in the Bürkert Communicator software, refer to the Operating Instructions Type 8920, available on the internet at country.burkert.com.

Do the following to display the generated messages on the display module:

-  Long press, to open the context menu.
-  **Messages overview** -----  Confirm.

 The generated messages are displayed. Some messages can be acknowledged.

10.7.4 Changing the login user level if the adjustment is not protected through passwords









By default:

- the **Installer** user level is active on the device,
- the adjustment is not protected through passwords,
- the symbol related to the **Installer** user level is not displayed in the information bar.

You can only change to the **Bürkert** user level.

- To change the login user level in the Bürkert Communicator software, refer to the Operating Instructions Type 8920, available on the internet at country.burkert.com.

Do the following to change the login user level on the display module:

-  Long press, to open the context menu.
-  **Change user level** -----  Confirm.
-  Choose the **Bürkert** user level -----  Confirm.
-   Enter the password -----  Confirm.

 The user level is changed.

- To activate the adjustment protection through passwords, refer to chapter [12.15](#).

10.7.5 Changing the login user level if the adjustment is protected through passwords



If the adjustment is protected through passwords, the symbol related to the active user level is displayed in the information bar.

→ To change the login user level in the Bürkert Communicator software, refer to the Operating Instructions Type 8920, available on the internet at country.burkert.com.

Do the following to change the login user level on the display module:



→  Long press, to open the context menu.

→  **Change user level** ----->  Confirm.

→  Choose **Logout** (not available if the basic user is logged in) ----->  Confirm.

→  Long press, to open the context menu.

→  **Change user level** ----->  Confirm.

→  Choose the user level ----->  Confirm.

→  Enter the password ----->  Confirm.

✓ The user level is changed. The related symbol is displayed in the information bar.

→ To deactivate the adjustment protection through passwords, refer to chapter [12.17](#).

10.7.6 Logging out from the **Advanced user**, **Installer** or **Bürkert** user level

If the adjustment is protected through passwords:

- the symbol related to the active user level is displayed in the information bar.
- you are automatically logged out after the activation delay of the screen saver has elapsed.

→ To log out from the active user level in the Bürkert Communicator software, refer to the Operating Instructions Type 8920, available on the internet at country.burkert.com.

Do the following to log out from the **Advanced user**, the **Installer** or the **Bürkert** user level and to go to the basic user level:

→  Long press, to open the context menu.

→  **Change user level** ----->  Confirm.



→  Choose **Logout** ----->  Confirm.

✓ The basic user level is active.

10.7.7 Reading out the access path to a menu item (display module only)

If you are lost in the menu structure, you can display the access path.

→  Long press, to open the context menu.

→  Where am I? ----->  Confirm.

✔ Read out the access path to the displayed menu item.

10.8 How to navigate in the menus and to adjust values

10.8.1 Adjusting a percentage or selecting a value in a list

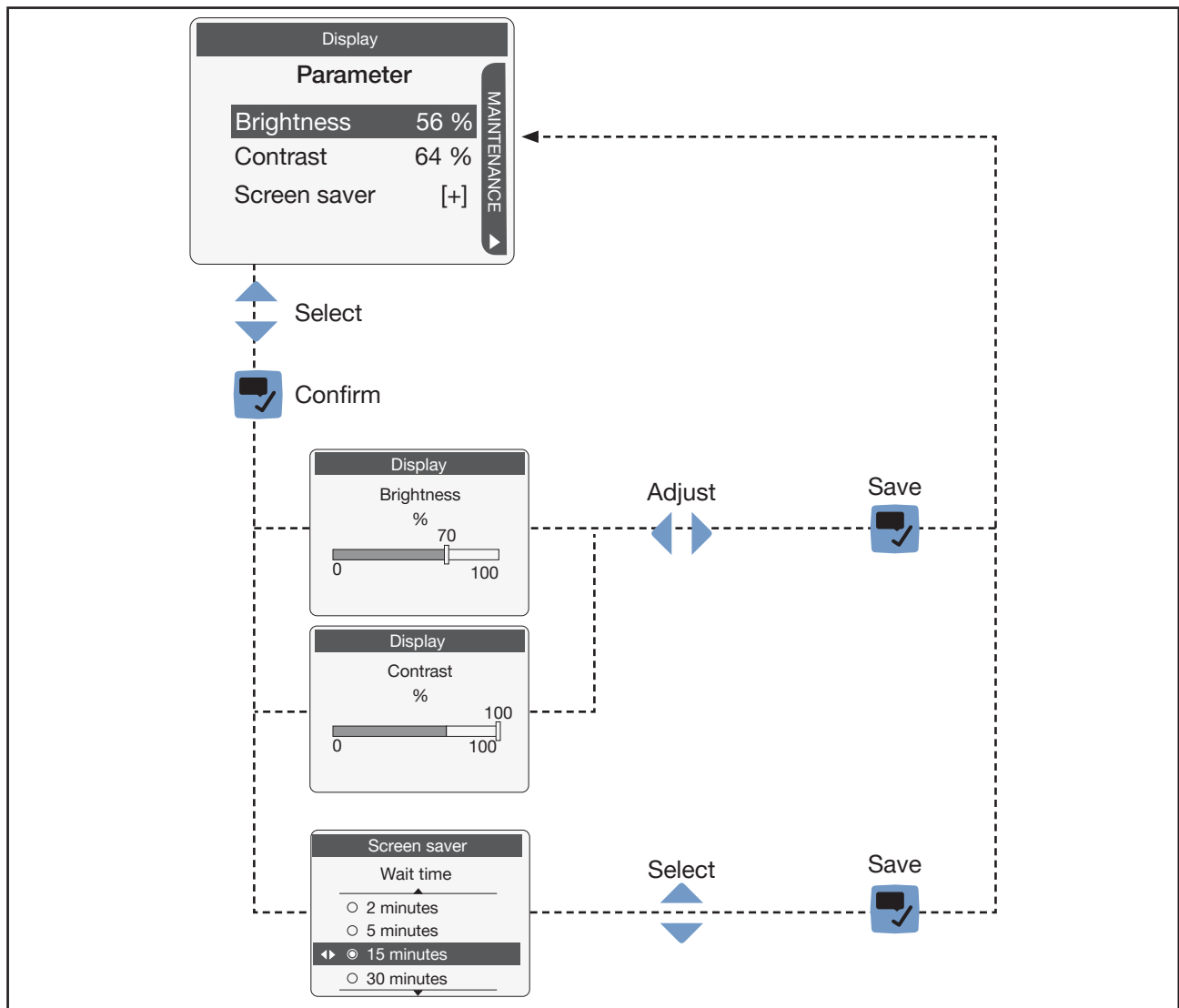

Fig. 44: Adjusting a percentage or selecting a value in a list

10.8.2 Navigating in a wizard and adjusting numbers

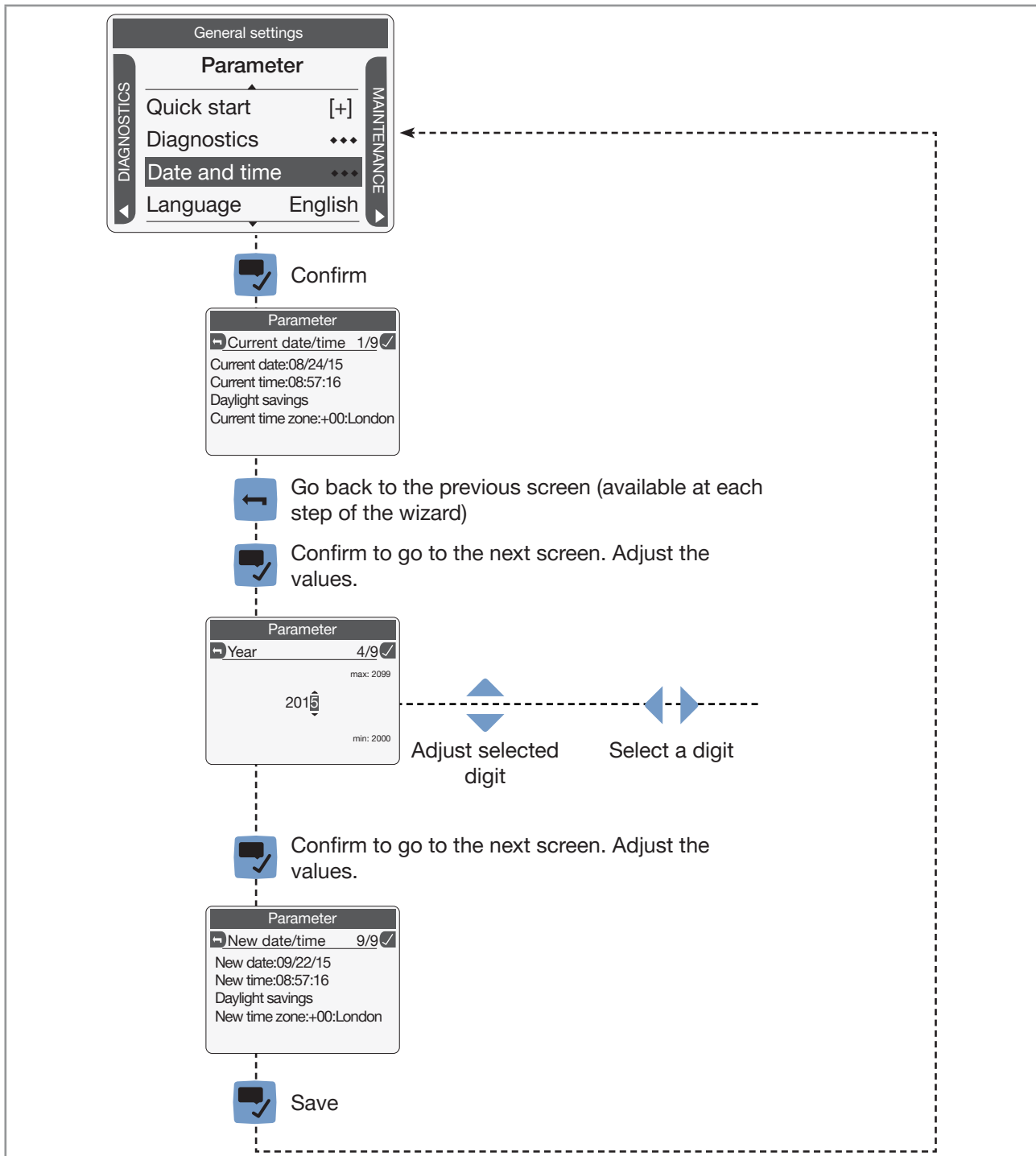
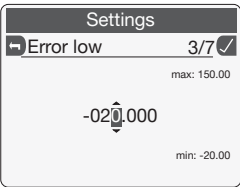
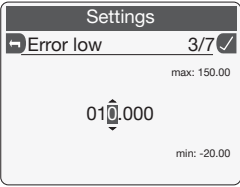

Fig. 45: Navigating in a wizard and adjusting numbers

10.8.3 Setting negative or positive numbers



To set a positive number:
→ ▲ to increase the number until the positive value is reached.



To set a negative number:
→ ▼ to decrease the number until the negative value is reached.

Fig. 46: Setting negative or positive numbers

10.8.4 Entering a name

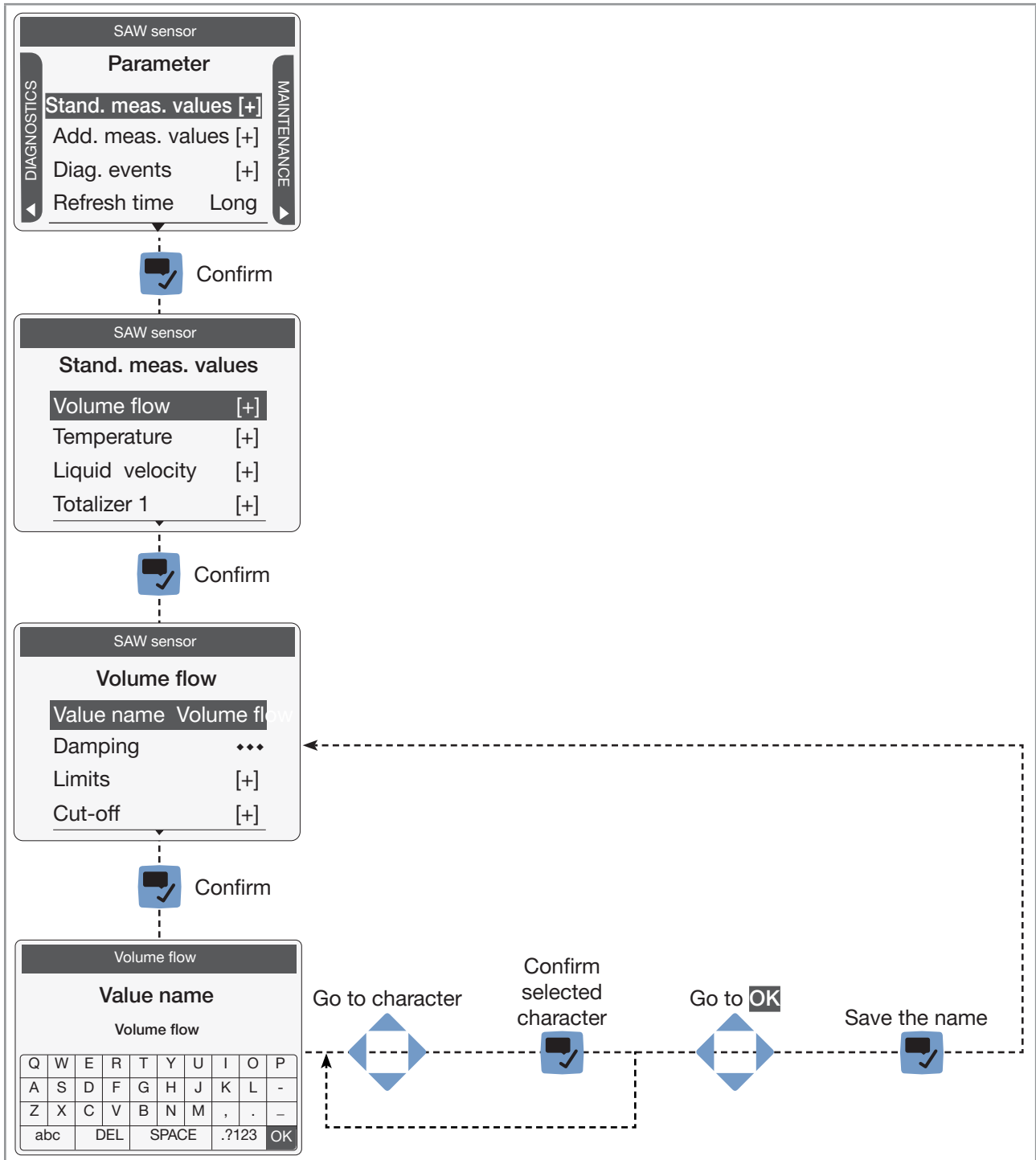

Fig. 47: Entering a name

10.8.5 Activating or deactivating a feature

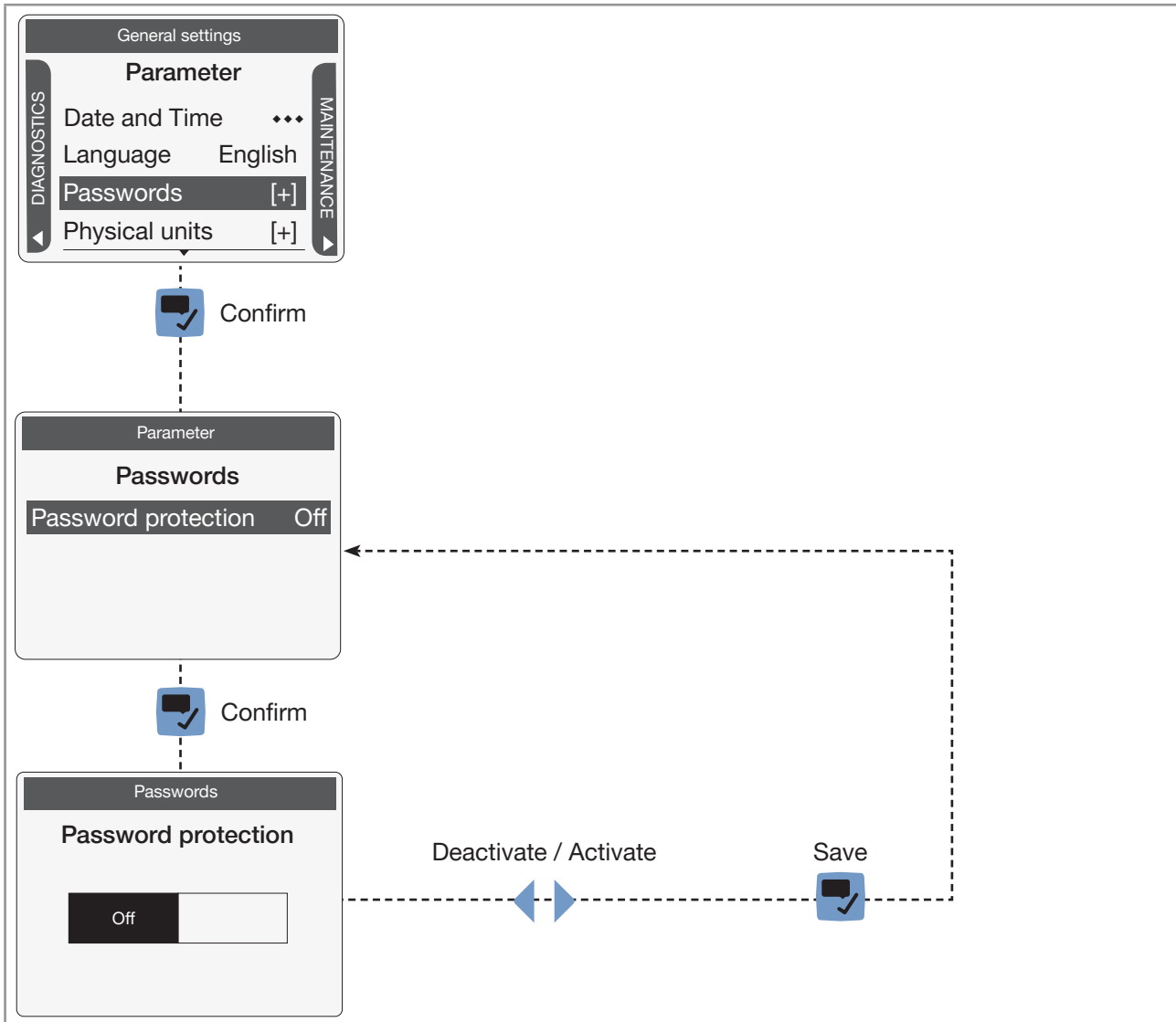

Fig. 48: Activating or deactivating a feature

Menu **Display**

11	DISPLAY MODULE SETTINGS.....	98
11.1	Safety instructions	98
11.2	Doing the Quick start adjustments when energizing the device for the first time (display module only).....	98
11.3	Menu Parameter.....	99
11.3.1	Adjusting the brightness of the display backlight.....	99
11.3.2	Adjusting the contrast of the display.....	99
11.3.3	Adjusting the activation delay of the screen saver	100
11.3.4	Adjusting the brightness of the backlight by active screen saver	100
11.3.5	Unlocking the screen saver.....	101
11.3.6	Changing the unlock sequence of the screen saver.....	101
11.4	Menu Diagnostics	102
11.4.1	Reading out the temperature of the display module	102
11.5	Menu Maintenance	102
11.5.1	Reading out the version number of the software of the display module.....	102
11.5.2	Reading out the version number of the hardware of the display module.....	103
11.5.3	Reading out the article number of the display module.....	103
11.5.4	Reading out the article number of the display module software	104
11.5.5	Reading out the serial number of the display module.....	104

11 DISPLAY MODULE SETTINGS

The section describes the menus related to the display module which is fitted on the device.

11.1 Safety instructions



WARNING

Risk of injury due to non-conforming adjustment.

Non-conforming adjustment could lead to injury and damage the device and its surroundings.

- ▶ The operators in charge of adjustment must have read and understood the contents of the Operating Instructions.
- ▶ In particular, observe the safety recommendations and intended use.
- ▶ The device/installation must only be adjusted by suitably trained staff.

11.2 Doing the **Quick start** adjustments when energizing the device for the first time (display module only)

When the device is energized for the first time, the user is guided to make the following mandatory settings:

- choosing the display language,
- choosing the time zone,
- choosing whether daylight saving (summer time) is automatically taken into account or not,
- setting the date and time,
- choosing the unit system for all the measurements.

When the device has finished the uploading step, the first screen of the **Quick start** is displayed.

- **Display**
- Choose the display language -----> Confirm. The current date and time settings are displayed in the chosen language.
- Choose the time zone -----> Confirm.
- Choose whether daylight saving (summer time) is automatically taken into account **(On)** or not **(Off)** for the display of the time. -----> Confirm.
- Set the year -----> Confirm.
- Set the month -----> Confirm.
- Set the day -----> Confirm.
- Set the hours -----> Confirm.
- Set the minutes -----> Confirm. The new date and time settings are displayed.
- Choose the unit system for all the measurements -----> Confirm.
- Save the **Quick start** settings or go back to the parent menu without saving the new settings.

11.3 Menu Parameter

11.3.1 Adjusting the brightness of the display backlight



The brightness of the display is automatically reduced if the internal device temperature is higher than +60 °C.

If the internal device temperature is higher than +60 °C, the brightness of the display is automatically reduced to 50 % and the backlight is even switched off 5 minutes after the last operation. If the temperature is higher than 80 °C the backlight is automatically switched off (0 %). If the display is operated, the backlight is put on for 30 s with a brightness of 50 %.

You can set 2 different values for the backlight brightness:

- 1 value if the screen saver is inactive,
- 1 value if the screen saver is active. Refer to chapter [11.3.4](#).

To set the backlight brightness if the screen saver is inactive, do the following:

→ Go to the **CONFIGURATION** view.

→ **Display**

→ Confirm to access the **Parameter** view.

→ **Brightness** ----->

→ Adjust the brightness of the backlight.

→ Save.

The brightness of the backlight is adjusted.

11.3.2 Adjusting the contrast of the display

→ Go to the **CONFIGURATION** view.

→ **Display**

→ Confirm to access the **Parameter** view.

→ **Contrast** ----->

→ Adjust the contrast.

→ Save.

The contrast of the display is adjusted.

11.3.3 Adjusting the activation delay of the screen saver

The screen saver allows you to:

- Save energy.
- Automatically go back to View 1.
- And, if the adjustment is protected through passwords, to be automatically logged out from an **Advanced user**, an **Installer** or a **Bürkert** user level after the activation delay of the screen saver has elapsed.

→ Go to the **CONFIGURATION** view.

→  **Display**

→  Confirm to access the **Parameter** view.

→  **Screen saver** -----> .

→  **Wait time** -----> .

→  Choose the time of inactivity of the display after which the screen saver is activated. ----->

 Save.

 The activation delay of the screen saver is adjusted.

11.3.4 Adjusting the brightness of the backlight by active screen saver

You can set 2 different values for the backlight brightness:

- 1 value if the screen saver is inactive, refer to chapter [11.3.1](#).
- 1 value if the screen saver is active.

To set the backlight brightness if the screen saver is active, do the following:



→ Go to the **CONFIGURATION** view.

→  **Display**

→  Confirm to access the **Parameter** view.

→  **Screen saver** -----> .

→  **Brightness** -----> .

→  Adjust the brightness of the backlight. ----->  Save.

 The brightness of the backlight is adjusted.

11.3.5 Unlocking the screen saver

To unlock the display when the screen saver is active, do the following to have access to any view again:

→ Press any key twice.

✔ The first key of the unlock sequence is displayed.

→ Press the displayed key.

→ Follow the displayed instructions.

✔ You have access to the display views and the screen saver time-out is restarted.

The default unlock sequence is the following:



→ To change the unlock sequence, refer to chapter [11.3.6](#).

11.3.6 Changing the unlock sequence of the screen saver

Do the following:



→ Go to the **CONFIGURATION** view.



→  **Display**



→  Confirm to access the **Parameter** view.

→  **Screen saver** -----> .

→  **Screen saver unlock sequence** -----> 

→  Choose the number of key presses. -----> 

→  Choose which key is pressed first. -----> 

→  Choose which key is pressed second. -----> 

→  Choose which key is pressed next, etc. -----> 









→  Save.

✔ The key sequence is changed.

11.4 Menu Diagnostics

11.4.1 Reading out the temperature of the display module









To read out the temperature of the display module, do the following:

- Go to the **CONFIGURATION** view.
-  **Display**
-  Confirm to access the **Parameter** view.
-  Go to the **DIAGNOSTICS** view.
-  **Temperature** -----> 
-  **Device temperature** ----->  -----> The temperature of the display module is displayed.
-  Go back to the parent menu.

11.5 Menu Maintenance

11.5.1 Reading out the version number of the software of the display module

To read out the version number of the software of the display module, do the following:

- Go to the **CONFIGURATION** view.
-  **Display**
-  Confirm to access the **Parameter** view.
-  Go to the **MAINTENANCE** view.
-  **Version numbers** -----> 
-  **Software version** ----->  -----> The version number of the software of the display module is displayed.
-  Go back to the parent menu.

11.5.2 Reading out the version number of the hardware of the display module

To read out the version number of the hardware of the display module, do the following:

→ Go to the **CONFIGURATION** view.

→  **Display**

→  Confirm to access the **Parameter** view.

→  Go to the **MAINTENANCE** view.

→  **Version numbers** -----> 

→  **Hardware version** ----->  -----> The version number of the hardware of the display module is displayed.

→  Go back to the parent menu.

11.5.3 Reading out the article number of the display module

To read out the article number of the display module, do the following:

→ Go to the **CONFIGURATION** view.

→  **Display**

→  Confirm to access the **Parameter** view.

→  Go to the **MAINTENANCE** view.









→  **Version numbers** -----> 

→  **Ident. number** ----->  -----> The article number of the display module is displayed.

→  Go back to the parent menu.









11.5.4 Reading out the article number of the display module software

To read out the article number of the display module software, do the following:

- Go to the **CONFIGURATION** view.
-  **Display**
-  Confirm to access the **Parameter** view.
-  Go to the **MAINTENANCE** view.
-  **Version numbers** -----> 
-  **Software ident. number** ----->  -----> The article number of the display module software is displayed.
-  Go back to the parent menu.

11.5.5 Reading out the serial number of the display module

To read out the serial number of the display module, do the following:

- Go to the **CONFIGURATION** view.
-  **Display**
-  Confirm to access the **Parameter** view.
-  Go to the **MAINTENANCE** view.
-  **Version numbers** -----> 
-  **Serial number** ----->  -----> The serial number of the display module is displayed.
-  Go back to the parent menu.

Menu **General settings**

12	GENERAL SETTINGS – PARAMETER	108
12.1	Safety instructions	108
12.2	User levels of the editable menu items	108
12.3	Default settings	108
12.4	Changing the operating mode of the device status indicator or switching off the device status indicator	109
12.4.1	Changing the operating mode of the device status indicator	109
12.4.2	Switching off the device status indicator	109
12.5	Setting the basic parameters for identifying the device on bÜS.....	110
12.5.1	Entering a name for the device	110
12.5.2	Entering the location of the device	110
12.5.3	Entering a description for the device.....	111
12.6	Setting the advanced parameters for identifying the device connected to bÜS or to a CANopen bus	111
12.6.1	Entering a unique name for the device.....	111
12.6.2	Changing the transmission speed on the device.....	112
12.6.3	Activating the device internal termination resistor.....	112
12.6.4	Deactivating the device internal termination resistor	113
12.6.5	Changing the address of the device connected to a CANopen bus.....	113
12.6.6	Setting the digital communication for bÜS or for a CANopen bus.....	114
12.6.7	Stop sending the measured process data (PDOs) to bÜS or to the CANopen fieldbus	115
12.7	Monitoring the device supply voltage or the device temperature	115
12.7.1	Reading out the 2 error limit values	117
12.7.2	Changing the 2 warning limit values	117
12.7.3	Reading out the hysteresis value.....	117
12.8	Reading out the low warning limit for the voltage of the internal battery	118
12.9	Start-up – Doing the basic settings	118
12.10	Activating the diagnostics function.....	119
12.11	Disabling all the diagnostics	120
12.12	Configuration provider.....	120
12.12.1	Reading out the status of the configuration provider	121
12.12.2	Replacing the data of the configuration memory.....	122
12.12.3	Transferring the configuration data of all the modules	122

12.13	Changing the date and the time	123
12.14	Changing the display language	123
12.15	Activating the adjustment protection through passwords	124
12.16	Changing the protection passwords of the Advanced user and Installer user levels	124
12.17	Deactivating the adjustment protection through passwords	125
12.18	Changing the units of the physical quantities	125
12.19	Displaying the text -- (NaN) or a numerical value	126
13	GENERAL SETTINGS – DIAGNOSTICS	127
13.1	User levels of the menu items	127
13.2	Reading out data related to the device.....	127
13.2.1	Reading out the number of operating hours of the device.....	127
13.2.2	Reading out the current value of the internal temperature of the device	128
13.2.3	Reading out the minimum or the maximum value of the internal temperature of the device.....	128
13.2.4	Reading out the current value of the supply voltage.....	128
13.2.5	Reading out the minimum or the maximum value of the supply voltage.....	129
13.2.6	Reading out the current value of the current consumption of the device	129
13.2.7	Reading out the minimum or the maximum value of the current consumption of the device.....	130
13.2.8	Reading out the number of device starts	130
13.2.9	Reading out the status of the configuration memory	130
13.2.10	Checking whether the date and time are correct.....	131
13.2.11	Checking the voltage of the internal battery	131
13.3	Reading out data related to bÜS	132
13.3.1	Reading out the number of current receive errors.....	132
13.3.2	Reading out the maximum number of receive errors since the last power-up of the device	132
13.3.3	Reading out the number of current transmit errors	132
13.3.4	Reading out the maximum number of transmit errors since the last power-up of the device	133
13.3.5	Resetting the 2 maximum error counters.....	133
13.3.6	Reading out whether the measured process data (PDO, process data object) is sent on bÜS or on the CANopen fieldbus.....	133

13.4	Configuration provider information	134
13.4.1	Reading out the current status of the configuration provider	134
13.4.2	Reading out the number of loaded client (module) configurations.....	135
13.4.3	Reading out the number of reconfigured clients (modules)	135
13.4.4	Reading out the number of managed modules.....	135
13.4.5	Reading out the number of missing modules	136
13.4.6	Reading out the number of failed configuration loads	136
13.4.7	Reading out the number of failed reconfigurations	137
13.4.8	Erasing the configuration data of a single module	137
14	GENERAL SETTINGS – MAINTENANCE	138
14.1	User levels of the menu items	138
14.2	Reading out some device information	138
14.2.1	Reading out the displayed name of the device.....	138
14.2.2	Reading out the article number of the device	138
14.2.3	Reading out the serial number of the device	139
14.2.4	Reading out the article number of the device software.....	139
14.2.5	Reading out the version number of the device software.....	139
14.2.6	Reading out the version number of the büS software	140
14.2.7	Reading out the version number of the device hardware.....	140
14.2.8	Reading out the Type number of the device	140
14.2.9	Reading out the manufacturing date of the device.....	141
14.2.10	Reading out the version of the embedded eds file	141
14.3	Resetting the device	142
14.3.1	Restarting the device	142
14.3.2	Resetting the device to all its factory settings	142
14.3.3	Updating the menu configuration of the device.....	143

12 GENERAL SETTINGS – PARAMETER

12.1 Safety instructions



WARNING

Risk of injury due to non-conforming adjustment.

Non-conforming adjustment could lead to injury and damage the device and its surroundings.

- ▶ The operators in charge of adjustment must have read and understood the contents of the Operating Instructions.
- ▶ In particular, observe the safety recommendations and intended use.
- ▶ The device/installation must only be adjusted by suitably trained staff.

12.2 User levels of the editable menu items

Menu item of the General settings – Parameter menu	Minimum user level
Status LED	Installer
büS – Displayed name	Advanced user
büS – Location	Advanced user
büS – Description	Advanced user
büS – Advanced	Installer
Alarm limits, except error limits	Installer
Alarm limits, error limits	Bürkert
Quick start	Installer
Diagnostics	Installer
Configuration provider	Installer
NaN Replacement	Installer
Date and time	Installer
Language	Advanced user
Passwords	Installer
Physical units	Advanced user

12.3 Default settings

You can find the default settings of the device in the CANopen supplement for the Type 8098 FLOWave L at country.burkert.com.

→ Before making any changes to the settings, use the Bürkert Communicator software to print a pdf file with all the default settings of the device.

12.4 Changing the operating mode of the device status indicator or switching off the device status indicator

By default, the device status indicator operates according to the NAMUR NE 107 standard (**NAMUR mode**).
The following other operating modes of the device status indicator are available:

- **Fixed color**: choose the permanent colour of the device status indicator.
- **LED off**: the device status indicator is always off.

12.4.1 Changing the operating mode of the device status indicator

To change the operating mode of the device status indicator, do the following:

→ Go to the **CONFIGURATION** view.

→  **General settings**

→  Confirm to access the **Parameter** view.

→  **Status LED** -----> 

→  **Mode** -----> 

→  Choose the operating mode of the device status indicator.

→  Save.

 The operating mode of the device status indicator is changed.

12.4.2 Switching off the device status indicator

To switch off the device status indicator, do the following:

→ Go to the **CONFIGURATION** view.

→  **General settings**

→  Confirm to access the **Parameter** view.

→  **Status LED** -----> 

→  **Mode** -----> 

→  **LED off**.

→  Save.

 The device status indicator is always off.

12.5 Setting the basic parameters for identifying the device on būs

The **Displayed name**, the **Location** and the **Description** allow you to clearly identify the device on būs.

12.5.1 Entering a name for the device

The entered name will be shown on any display (e.g. the Communicator software) connected to būs.

To enter the name of the device that will be shown on any display connected to būs, do the following:

→ Go to the **CONFIGURATION** view.

→  **General settings**

→  Confirm to access the **Parameter** view.

→  **būs** -----> 

→  **Displayed name** -----> 

→    Enter the name by selecting and confirming each character.

→   **OK**

→  Save the name.

 The name is set.

12.5.2 Entering the location of the device

The entered location will be shown on any display (e.g. the Communicator software) connected to būs.

To enter the information where the device is geographically located, do the following:

→ Go to the **CONFIGURATION** view.

→  **General settings**

→  Confirm to access the **Parameter** view.

→  **būs** -----> 

→  **Location** -----> 

→    Enter the location by selecting and confirming each character.

→   **OK**

→  Save the location.

 The location is set.

12.5.3 Entering a description for the device

The description allows you to precisely identify this device. To enter a description for the device, do the following:

→ Go to the **CONFIGURATION** view.

→  **General settings**

→  Confirm to access the **Parameter** view.

→  **büS** -----> 

→  **Description** -----> 

→    Enter the description (max. 19 characters) by selecting and confirming each character.

→   **OK**

→  Save the description.

 The description is set.

12.6 Setting the advanced parameters for identifying the device connected to büS or to a CANopen bus

12.6.1 Entering a unique name for the device



- Only change the **Unique device name** of a device if 2 devices with the same name are connected to büS or to a CANopen bus.
- If the **Unique device name** of the device is changed, the participants on büS or to a CANopen bus lose the link to the device. The link between the participants must then be restored.

The **Unique device name** of the device is used by the participants connected to büS or to a CANopen bus. To change the **Unique device name**, do the following:

→ Go to the **CONFIGURATION** view.

→  **General settings**

→  Confirm to access the **Parameter** view.

→  **büS** -----> 

→  **Advanced** -----> 

→  **Unique device name** -----> 

→    Enter the name by selecting and confirming each character.

→   OK

→  Save the name.

 The unique name is set.

12.6.2 Changing the transmission speed on the device

The transmission speed for the communication on the fieldbus (both büS or CANopen) must be the same for all the participants of the fieldbus.

By default, the transmission speed of the device is 500 kbit/s. This transmission speed is suited for a maximum cable length of 50 m.

If the cable length is higher, reduce the transmission speed of all the participants.

To change the transmission speed of the device, do the following:

→ Go to the **CONFIGURATION** view.

→  **General settings**

→  Confirm to access the **Parameter** view.

→  büS 

→  **Advanced** 

→  **Baudrate** 

→  Choose the transmission speed.

→  Save.

 The transmission speed of the device is changed. To take the transmission speed into account, restart the device.

12.6.3 Activating the device internal termination resistor

If the device is connected to a CANopen fieldbus or to büS, a 120 Ω termination resistor must be installed at each end of the fieldbus or of büS.

To avoid installing a physical termination resistor, the device has an internal 120 Ω termination resistor that can be activated if the device is installed at one end of the büS network or at one end of the CANopen network.



- If you activate the device internal termination resistor, do not install a termination resistor at the same end of büS or of the CANopen fieldbus.
- Max. two 120 Ω termination resistors can equip büS or a CANopen fieldbus.

To activate the device internal termination resistor, do the following:

→ Go to the **CONFIGURATION** view.

→  **General settings**

→  Confirm to access the **Parameter** view.

→  **büS** -----> 

→  **Advanced** -----> 

→  **Termination resistor** -----> 

→  **On**

→  Save.

 The internal termination resistor is activated.

12.6.4 Deactivating the device internal termination resistor

If the device is not installed at the end of büS or of a CANopen fieldbus, deactivate the device internal termination resistor.

 Max. two 120 Ω termination resistors can equip büS or a CANopen fieldbus.

To deactivate the device internal termination resistor, do the following:

→ Go to the **CONFIGURATION** view.

→  **General settings**

→  Confirm to access the **Parameter** view.

→  **büS** ----->  ----->  **Advanced** -----> 

→  **Termination resistor** ----->  ----->  **Off**

→  Save.

 The internal 120 Ω termination resistor is deactivated.

12.6.5 Changing the address of the device connected to a CANopen bus













The address of the device is used by büS or the CANopen fieldbus the device can be connected to.

- If the device is connected to büS, büS automatically addresses the device. By default, the address of the device on büS is 30.
- If the device is connected to a CANopen fieldbus, the addresses are not set automatically.

→ Make sure that each participant, including the device, connected to the CANopen fieldbus has a specific address.

If the device is connected to a CANopen fieldbus and another participant connected to the fieldbus has the same address, do the following to change the address of the device:

→ Go to the **CONFIGURATION** view.













-  **General settings**
-  Confirm to access the **Parameter** view.
-  **büS** ----->  ----->  **Advanced** -----> 
-  **büS address** -----> 
-   Change the address of the device. Make sure you enter an address that is not already used on the same CANopen fieldbus.
-  Save.
-  The address of the device is changed.
- Start the device to take the new address into account. See chapter [14.3.1 Restarting the device](#).

12.6.6 Setting the digital communication for büS or for a CANopen bus

By default, the operating mode of the digital communication is set to **Standalone** and the measured process data (PDOs, process data objects) is not sent on a connected fieldbus.

The other operating modes of the digital communication are **büS** or **CANopen**.

If the device is connected to büS or to a CANopen bus, do the following to change the operating mode of the digital communication:

- Go to the **CONFIGURATION** view.
-  **General settings**
-  Confirm to access the **Parameter** view.
-  **büS** -----> 
-  **Advanced** -----> 
-  **Bus mode** -----> 
-  **büS** or **CANopen**.
-  Save.
- Restart the device.
-  The operating mode of the digital communication is büS or CANopen.
-  If the operating mode of the digital communication is büS, the **CANopen status** is set to **Operational** (see chapter [13.3.6](#)) and the PDOs are sent to büS.
-  If the operating mode of the digital communication is CANopen, the **CANopen status** is set to **Pre-op** (see chapter [13.3.6](#)) until the CANopen network master switches the device to **Operational**.
- To stop the PDOs being sent to büS or to a fieldbus, see chapter [12.6.7](#).

12.6.7 Stop sending the measured process data (PDOs) to bÜS or to the CANopen fieldbus

If the device is connected to bÜS or to a CANopen fieldbus and the **Bus mode** is set to **bÜS** or to **CANopen** and you want to temporarily stop sending the PDOs to bÜS or to the CANopen fieldbus, do the following:

→ Go to the **CONFIGURATION** view.

→  **General settings**

→  Confirm to access the **Parameter** view.

→  **bÜS** ----->  ----->  **Advanced** -----> 

→  **Bus mode** -----> 

→  **Standalone**

→  **Save**.

→ Restart the device.

 The **CANopen status** is set to **Pre-op** and the PDOs are not sent to bÜS or to a CANopen fieldbus.

 The communication with the software Bürkert Communicator is still operational.

→ To enable the transmission of the PDOs to bÜS or to a fieldbus, see chapter [12.6.6](#).

12.7 Monitoring the device supply voltage or the device temperature

The supply voltage of the device and the internal temperature of the device are monitored.

A monitored value can be:

- in the normal operating range,
- in the warning range,
- in the error range.

4 limit values are set, 2 error limits and 2 warning limits. The error limits can only be read but the warning limits can be adjusted.

[Fig. 49](#) explains how the device reacts when the monitored value enters into another range (for example, from the normal range into the warning range). The reaction time depends on the hysteresis value and on whether the monitored value increases or decreases.

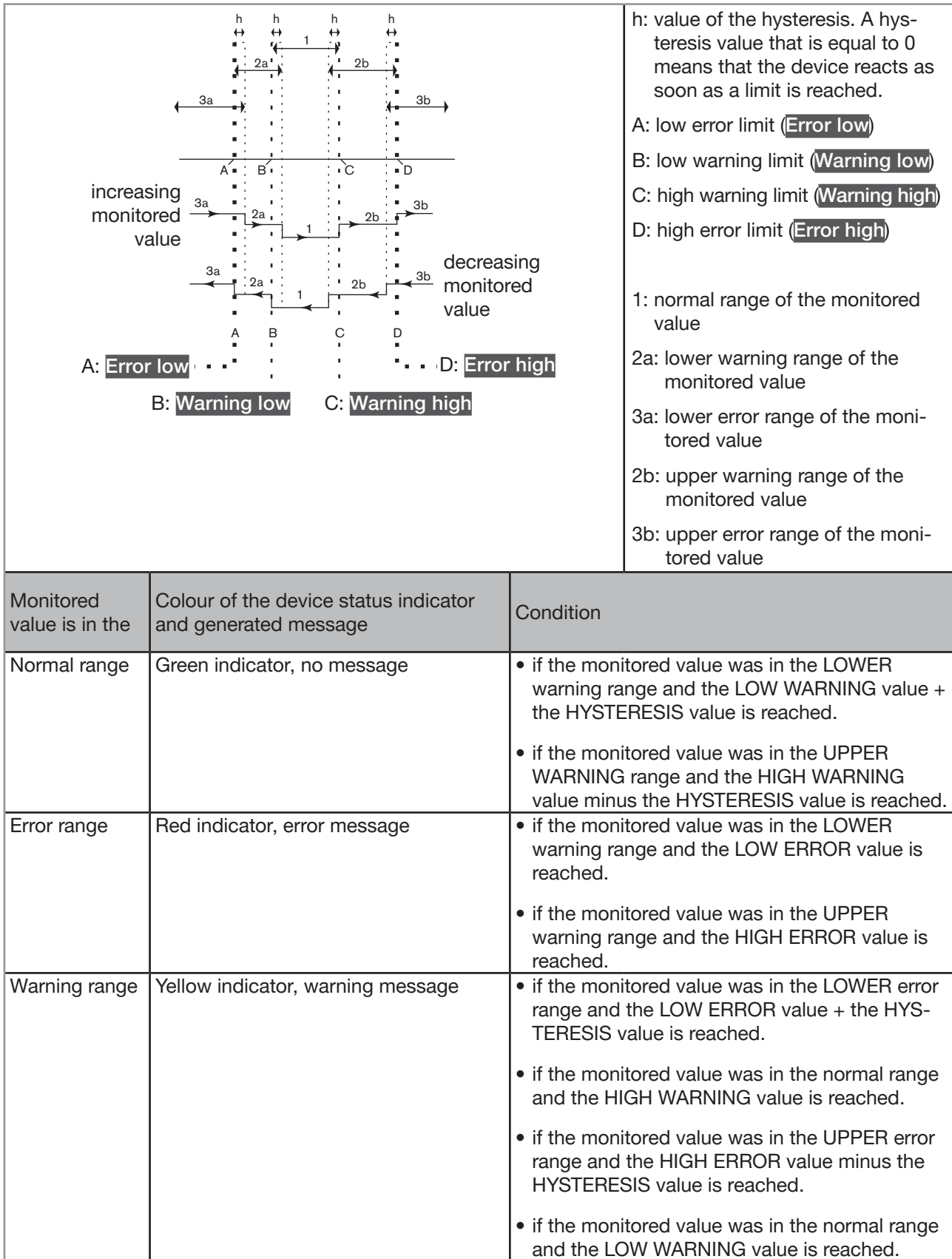









MAN 1000273158 EN Version: M Status: RL (released | freigegeben) printed: 22.06.2022

Fig. 49: Operating principle of monitoring with a hysteresis











12.7.1 Reading out the 2 error limit values

To read out the limits the supply voltage of the device should be in, do the following:

- Go to the **CONFIGURATION** view.
-  **General settings**
-  Confirm to access the **Parameter** view.
-  **Alarm limits** -----> 
-  **Supply voltage** or **Device temperature** -----> 
-  **Error high** or **Error low** -----> 
-  Go back to the parent menu.







12.7.2 Changing the 2 warning limit values

To change the warning limits of the supply voltage or of the device temperature, do the following:

- Go to the **CONFIGURATION** view.
-  **General settings**
-  Confirm to access the **Parameter** view.
-  **Alarm limits** -----> 
-  **Supply voltage** or **Device temperature** -----> 
-  **Warning high** or **Warning low** -----> 
-   Set the warning limit.
-  Save.
- ✔ The warning limits are changed.

12.7.3 Reading out the hysteresis value

To read out the hysteresis value, do the following:

- Go to the **CONFIGURATION** view.
-  **General settings**
-  Confirm to access the **Parameter** view.
-  **Alarm limits** -----> 
-  **Supply voltage** or **Device temperature** -----> 

→  **Hysteresis** -----> 

→  Go back to the parent menu.

12.8 Reading out the low warning limit for the voltage of the internal battery



The device has a small battery to store energy so that the time system can run for 7 days when the device is not powered.

To read out the value of the low warning limit, do the following:

→ Go to the **CONFIGURATION** view.

→  **General settings**

→  **Alarm limits** -----> 

→  **Warning battery voltage low** -----> 

→  Go back to the parent menu.

12.9 Start-up – Doing the basic settings

The **Quick start** settings are the same as those made when the device is energized for the first time.

To change the **Quick start** settings, do the following:



→ Go to the **CONFIGURATION** view.



→  **General settings**



→  Confirm to access the **Parameter** view.



→  **Quick start**



→  **Display**



→  Choose the display language ----->  The current date and time settings are displayed in the chosen language.











→  Choose the time zone -----> 

→  Choose whether daylight saving (summer time) is automatically taken into account (**On**) or not (**Off**) for the display of the time. -----> 

→   Set the year -----> 

→   Set the month -----> 

→   Set the day -----> 

-   Set the hours -----> 
-   Set the minutes ----->  The new date and time settings are displayed.
-  Choose the unit system for all the measurements ----->  Confirm.
-  Save the **Quick start** settings or  go back to the parent menu without saving the new settings.

12.10 Activating the diagnostics function

WARNING









Risk of injury due to non-conforming adjustment.

Non-conforming adjustment could lead to injuries and damage the device and its surroundings.

- ▶ The operators in charge of adjustment must have read and understood the contents of the Operating Instructions.
- ▶ In particular, observe the safety recommendations and intended use.
- ▶ The device/installation must only be adjusted by suitably trained staff.

By default, all the diagnostics events related to the process, the electronics or the sensor, the messages related to the monitoring of the process values (e.g. the flow rate) and the messages related to problems on the device and on büS are disabled.

To activate the diagnostics, do the following:

- Activate the needed diagnostics events. See chapter [15.14](#).
- Activate the monitoring of the process variables that must be monitored. See chapter [15.4.5](#), chapter [15.6.5](#), chapter [15.8.5](#), chapter [15.10.3](#), chapter [15.12.6](#), chapter [15.13.7](#).
- Go to the **CONFIGURATION** view.
-  **General settings**
-  Confirm to access the **Parameter** view.
-  **Diagnostics** ----->  Read the displayed message -----> 
-  **Active** -----> 
-  Save and restart the device.
- ✔ The needed diagnostics are active.

12.11 Disabling all the diagnostics



By default, all the diagnostics events related to the process, the electronics or the sensor, the messages related to the monitoring of the process values (e.g. the flow rate) and the messages related to problems on the device and on bÜS are disabled.

If the diagnostics are active on the device, do the following to disable them:

→ Go to the **CONFIGURATION** view.

→  **General settings**

→  Confirm to access the **Parameter** view.

→  **Diagnostics** ----->  Read the displayed message -----> 

→  **Inactive** -----> 

→  Save and restart the device.

 All the diagnostics are disabled.

12.12 Configuration provider

If active on the device, the configuration provider manages the configuration data of the device modules (for example, display module, Ethernet module,...). The configuration provider does not manage the configuration data of the transmitter board. The transmitter board directly saves its configuration data on the configuration memory.

→ Make sure the configuration provider is active on the device. Refer to chapter [12.12.1](#).

→ Make sure a configuration memory (SIM card) is inserted in its slot on the device. Refer to [Fig. 50](#) or to the parameter **Transferable memory status** described in chapter [13.2.9 Reading out the status of the configuration memory](#).

→ Make sure you use a configuration memory from Bürkert. Configuration memories can be bought from your Bürkert branch office.

Upon the device startup, the device can have one of the following behaviours:

- If the configuration memory is empty or contains data from a device with a previous software version, the configuration memory is formatted and the current configuration data is saved on it.
- If the configuration memory contains data which is compatible with the configuration provider, the serial numbers of the modules with the same article number are compared:
 - If the serial numbers are different, the configuration provider copies the configuration data from the configuration memory to the device modules.
 - If the serial numbers are the same, the configuration data are not copied.
 - If the device is equipped with an additional module, its configuration data is saved on the configuration memory.
- The configuration provider automatically saves the configuration data of a module as soon as a module setting has been changed.

- On request, the configuration provider replaces the configuration data on the memory card with the current configuration data of the equipped modules. See chapter 12.12.2. For example, this is useful to remove from the configuration memory, the configuration data of a removed module.
- On request, the configuration provider transfers the configuration data of all the modules from the configuration memory to the device. The modules with the same article numbers must have the same serial numbers. Refer to chapter 12.12.3.

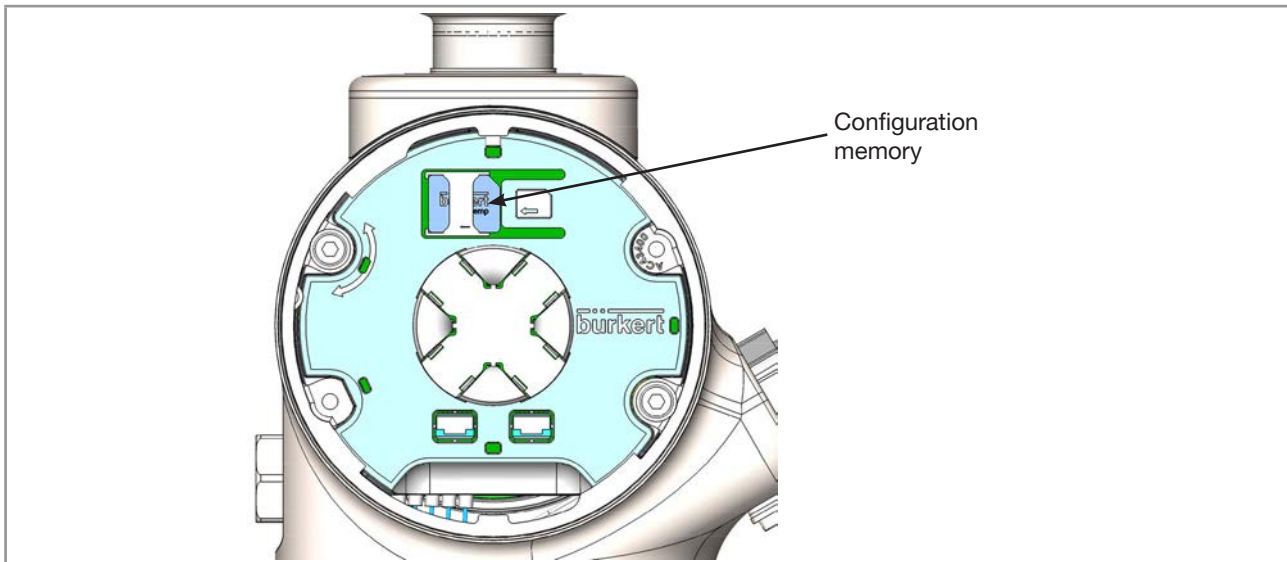

Fig. 50: Location of the configuration memory (SIM card)

12.12.1 Reading out the status of the configuration provider

Do the following:

- Go to the **CONFIGURATION** view.
- **General settings**
- Confirm to access the **Parameter** view.
- **Configuration provider** ----->
- **Status** ----->
- Go back to the parent menu.

12.12.2 Replacing the data of the configuration memory

If you want to replace the configuration data which is stored on the configuration memory by the current configuration data of all the device modules, do the following:

→ Go to the **CONFIGURATION** view.

→  **General settings**

→  Confirm to access the **Parameter** view.

→  **Configuration provider** -----> 

→  **Erase all client configurations** -----> 

→  **On**

→  Save.

→ Restart the device.

 The current configuration data of all the device modules has been stored on the configuration memory. The previous configuration data has been removed from the configuration memory.

 The parameter **Erase all client configurations** is automatically set to **Off**.

12.12.3 Transferring the configuration data of all the modules

On request, the configuration provider transfers the configuration data of all the modules from the configuration memory to the device. The modules with the same article numbers must have the same serial numbers.

Do the following:

→ Go to the **CONFIGURATION** view.

→  **General settings**

→  Confirm to access the **Parameter** view.

→  **Configuration provider** -----> 

→  **Force reconfiguration of all clients** -----> 

→  **On**

→  Save.

→ Restart the device.

 The configuration data of all the device modules has been transferred from the configuration memory to the device.

 The parameter **Force reconfiguration of all clients** is automatically set to **Off**.

12.13 Changing the date and the time

The date and time are set in the **Quick start** settings when the device is energized for the first time.



To change the date and time, do the following:



→ Go to the **CONFIGURATION** view.



→  **General settings**

→  Confirm to access the **Parameter** view.



→  **Date and time** -----> 



→  Choose the time zone -----> 

→  Choose whether the summer time is automatically set (**On**) or not (**Off**) for the display of the time.
----->  Confirm.

→   Set the year -----> 

→   Set the month -----> 

→   Set the day -----> 

→   Set the hours -----> 

→   Set the minutes ----->  -----> The **New settings** are displayed ----->  Save.

 The date and time are set.

12.14 Changing the display language

By default, the display language is English.

The display language is set in the **Quick start** settings, when the device is energized for the first time.

To change the display language, do the following:

→ Go to the **CONFIGURATION** view

→  **General settings**

→  Confirm to access the **Parameter** view.

→  **Language** -----> 

→  Choose the language.

→  Save.









 The display language is changed.

12.15 Activating the adjustment protection through passwords

By default, the device adjustment is not protected by passwords.

The default user level is the **Installer** level.

To activate the adjustment protection through passwords, do the following:













- Go to the **CONFIGURATION** view
-  **General settings**
-  Confirm to access the **Parameter** view.
-  **Passwords** -----> 
-  **Password protection** -----> 
-  Choose **On**
-  Save
-  The protection through passwords is enabled.

12.16 Changing the protection passwords of the **Advanced user** and **installer** user levels

If the protection through passwords is active, you can change the passwords of the **Advanced user** and **installer** user levels.

The lowest user level is not protected through a password.

To change the passwords of the **Advanced user** and **installer** user levels, do the following:

- Go to the **CONFIGURATION** view
-  **General settings**
-  Confirm to access the **Parameter** view.
-  **Passwords** -----> 
-  **Change passwords** -----> 
-  **Advanced user** or **Installer** -----> 
-   Set the new password.
-  Save
-  The password is changed.

→ If you have forgotten your passwords, you can restore the default passwords with the Type 8920 Communicator software.

12.17 Deactivating the adjustment protection through passwords

By default, the device adjustment is not protected by passwords.

The default user level is the **Installer** level.

If the adjustment protection through passwords has been activated, do the following to deactivate it:

→ Go to the **CONFIGURATION** view

→  **General settings**

→  Confirm to access the **Parameter** view.

→  **Passwords** -----> 

→  **Password protection** -----> 

→  Choose **Off**

→  Save

 The protection through passwords is disabled.









12.18 Changing the units of the physical quantities

The physical quantities, used by the device, are displayed on the device with the following default units (in the metric unit system):

- current: mA (milliamperes)
- density: g/cm³ (grams per cubic centimetre)
- flow rate: l/min (liters per minute)
- frequency: Hz (Hertz)
- length: mm (millimeters)
- mass: g (grams)
- mass flow rate: kg/h (kilograms per hour)
- velocity: m/s (meters per second)
- temperature: °C (degrees Celsius)
- temperature difference: °C (degrees Celsius)
- time: s (seconds)
- voltage: V (Volts)
- volume: l (liters)

To change the units of a physical quantity, do the following:







→ Go to the **CONFIGURATION** view

-  **General settings**
-  Confirm to access the **Parameter** view.
-  **Physical units** -----> 
-  Choose the physical quantity -----> 
-  Choose the units ----->  Save
-  The units are changed.



12.19 Displaying the text -- (NaN) or a numerical value

If the device cannot measure a process value, then the display module will display either the text -- or a numerical value. The Bürkert Communicator software will display NaN instead of --.

Whether to display the text -- (NaN) or the numerical value, do the following:









- Go to the **CONFIGURATION** view.
-  **General settings**
-  Confirm to access the **Parameter** view.
-  **NaN Replacement** -----> 
-  **NaN Process values** -----> . A list of process values is displayed.

- To display the text -- or NaN, do the following:

-   Deselect all the process values.
-  Save.

 If the device cannot measure a selected process value, then the display module shows --. The Bürkert Communicator software displays NaN instead of --.

- To display a numerical value, do the following:

-   Select the related process values ----->  Save.
-  **NaN Replacement value** -----> 
-   Set the numerical value -----> . The numerical value is applied to all the selected process values.
-  Save.

 If the device cannot measure a selected process value, then the display module and the Bürkert Communicator software display the numerical value.

13 GENERAL SETTINGS – DIAGNOSTICS

13.1 User levels of the menu items

Menu item of the General settings – Diagnostics menu	Minimum user level
Device status	Basic user
büS status – Receive errors	Advanced user
büS status – Receive errors max.	Advanced user
büS status – Transmit errors	Advanced user
büS status – Transmit errors max.	Advanced user
büS status – Reset error counter	Installer
Configuration provider – Status	Basic user
Configuration provider – Number of loaded client configurations	Basic user
Configuration provider – Number of reconfigured clients	Basic user
Configuration provider – Number of managed devices	Basic user
Configuration provider – Number of missing devices	Basic user
Configuration provider – Number of failed configuration loads	Basic user
Configuration provider – Number of failed reconfigurations	Basic user
Configuration provider – Managed devices	Installer (Bürkert Communicator only)

13.2 Reading out data related to the device









13.2.1 Reading out the number of operating hours of the device

To read out the number of hours the device has already been operating, do the following:

- Go to the **CONFIGURATION** view.
- **General settings**
- Confirm to access the **Parameter** view.
- Go to the **DIAGNOSTICS** view.
- **Device status** ----->
- **Operating duration** -----> -----> The number of operating hours of the device is displayed.
- Go back to the parent menu.











13.2.2 Reading out the current value of the internal temperature of the device

To read out the current value of the internal temperature of the device, do the following:

- Go to the **CONFIGURATION** view.
-  **General settings**
-  Confirm to access the **Parameter** view.
-  Go to the **DIAGNOSTICS** view.
-  **Device status** ----->  ----->  **Device temperature** -----> 
-  Go back to the parent menu.





13.2.3 Reading out the minimum or the maximum value of the internal temperature of the device



To read out the minimum or the maximum value of the internal temperature of the device since the first power-up of the device, do the following:

- Go to the **CONFIGURATION** view.
-  **General settings**
-  Confirm to access the **Parameter** view.
-  Go to the **DIAGNOSTICS** view.
-  **Device status** -----> 
-  **Min./Max. values** -----> 
-  **Max. temperature** or **Min. temperature** ----->  -----> The minimum or the maximum value of the internal temperature of the device is displayed.
-  Go back to the parent menu.

13.2.4 Reading out the current value of the supply voltage











To read out the current value of the supply voltage, do the following:

- Go to the **CONFIGURATION** view.
-  **General settings**
-  Confirm to access the **Parameter** view.
-  Go to the **DIAGNOSTICS** view.
-  **Device status** -----> 

-  **Supply voltage** ----->  -----> The value of the supply voltage is displayed.
-  Go back to the parent menu.









13.2.5 Reading out the minimum or the maximum value of the supply voltage

To read out the minimum or the maximum value of the supply voltage since the last power-up of the device, do the following:

- Go to the **CONFIGURATION** view.
-  **General settings**
-  Confirm to access the **Parameter** view.
-  Go to the **DIAGNOSTICS** view.
-  **Device status** -----> 
-  **Min./Max. values** -----> 
-  **Max. supply voltage** or **Min. supply voltage** ----->  -----> The minimum or the maximum value of the supply voltage is displayed.
-  Go back to the parent menu.











13.2.6 Reading out the current value of the current consumption of the device

To read out the value of the current consumption of the device, do the following:

- Go to the **CONFIGURATION** view.
-  **General settings**
-  Confirm to access the **Parameter** view.
-  Go to the **DIAGNOSTICS** view.
-  **Device status** -----> 
-  **Current consumption** ----->  -----> The value of the current consumption of the device is displayed.
-  Go back to the parent menu.









13.2.7 Reading out the minimum or the maximum value of the current consumption of the device

To read out the minimum or the maximum value of the current consumption of the device since the first power-up of the device, do the following:

- Go to the **CONFIGURATION** view.
-  **General settings**
-  Confirm to access the **Parameter** view.
-  Go to the **DIAGNOSTICS** view.
-  **Device status** -----> 
-  **Min./Max. values** -----> 
-  **Max. current consumption** or **Min. current consumption** ----->  -----> The minimum or the maximum value of the current consumption of the device is displayed.
-  Go back to the parent menu.



13.2.8 Reading out the number of device starts





To read out the number of restarts of the device, do the following:

- Go to the **CONFIGURATION** view.
-  **General settings**
-  Confirm to access the **Parameter** view.
-  Go to the **DIAGNOSTICS** view.
-  **Device status** -----> 
-  **Device boot counter** -----> 
-  Go back to the parent menu.

13.2.9 Reading out the status of the configuration memory









To read out the status of the configuration memory, do the following:

- Go to the **CONFIGURATION** view.
-  **General settings**
-  Confirm to access the **Parameter** view.
-  Go to the **DIAGNOSTICS** view.

-  **Device status** -----> 
-  **Transferable memory status** -----> 
-  Go back to the parent menu.

13.2.10 Checking whether the date and time are correct









To check whether the date and time are still correct on the device, do the following:

- Go to the **CONFIGURATION** view.
-  **General settings**
-  Confirm to access the **Parameter** view.
-  Go to the **DIAGNOSTICS** view.
-  **Device status** -----> 
-  **Current system time** -----> 
-  Go back to the parent menu.

13.2.11 Checking the voltage of the internal battery

The device has a small battery to store energy so that the time system can run for 7 days when the device is not powered.









To check the voltage of the internal battery, do the following:

- Go to the **CONFIGURATION** view.
-  **General settings**
-  Confirm to access the **Parameter** view.
-  Go to the **DIAGNOSTICS** view.
-  **Device status** -----> 
-  **Battery voltage** -----> 
-  Go back to the parent menu.

13.3 Reading out data related to būs









13.3.1 Reading out the number of current receive errors

To read out the number of current receive errors, do the following:

- Go to the **CONFIGURATION** view.
-  **General settings**
-  Confirm to access the **Parameter** view.
-  Go to the **DIAGNOSTICS** view.
-  **būs status** -----> 
-  **Receive errors** -----> 
-  Go back to the parent menu.





13.3.2 Reading out the maximum number of receive errors since the last power-up of the device



To read out the maximum number of receive errors, do the following:

- Go to the **CONFIGURATION** view.
-  **General settings**
-  Confirm to access the **Parameter** view.
-  Go to the **DIAGNOSTICS** view.
-  **būs status** -----> 
-  **Receive errors max.** -----> 
-  Go back to the parent menu.

13.3.3 Reading out the number of current transmit errors

To read out the number of current transmit errors, do the following:

- Go to the **CONFIGURATION** view.
-  **General settings**
-  Confirm to access the **Parameter** view.
-  Go to the **DIAGNOSTICS** view.
-  **būs status** -----> 

→  Transmit errors -----> 

→  Go back to the parent menu.

13.3.4 Reading out the maximum number of transmit errors since the last power-up of the device

To read out the maximum number of transmit errors, do the following:

→ Go to the **CONFIGURATION** view.

→  General settings

→  Confirm to access the **Parameter** view.

→  Go to the **DIAGNOSTICS** view.

→  bus status ----->  ----->  Transmit errors max. -----> 

→  Go back to the parent menu.

13.3.5 Resetting the 2 maximum error counters

To reset the 2 maximum error counters, do the following:

→ Go to the **CONFIGURATION** view.

→  General settings

→  Confirm to access the **Parameter** view.

→  Go to the **DIAGNOSTICS** view.

→  bus status -----> 

→  Reset error counter -----> 

→  Confirm.

 The 2 maximum error counters are reset.

13.3.6 Reading out whether the measured process data (PDO, process data object) is sent on bus or on the CANopen fieldbus

To read out whether the measured process data (PDO, process data object) is sent on bus or on the CANopen fieldbus, do the following:

→ Go to the **CONFIGURATION** view.

→  General settings

→  Confirm to access the **Parameter** view.

→  Go to the **DIAGNOSTICS** view.

→  **büS status** -----> 

→  **CANopen status** -----> 

- If the CANopen status is **Operational**, the PDOs are sent to büS.
- If the CANopen status is **Pre-Op** (pre-operational), the PDOs are not sent on büS or on the CANopen fieldbus and a message is generated in the message list. For example, the **Pre-Op** status is active if the **Bus mode** is set to **Standalone** (see chapter 12.6.7).

→  Go back to the parent menu.

13.4 Configuration provider information

13.4.1 Reading out the current status of the configuration provider

Do the following:

→ Go to the **CONFIGURATION** view.

→  **General settings**

→  Confirm to access the **Parameter** view.

→  Go to the **DIAGNOSTICS** view.

→  **Configuration provider** -----> 

→  **Status** -----> 

→  Go back to the parent menu.









Table 23: Possible statuses of the configuration provider

Status	Meaning
Provider start	The configuration provider is starting.
Wait for changes	The configuration provider operates normally and is waiting for changes of a client (module).
Initialization	The configuration provider is initializing.
Wait for clients	The configuration provider has initialized successfully and is waiting for clients (modules).
Verify clients	The configuration provider is checking if the clients (modules) are available, are missing or have been replaced.
Retrigger clients	The configuration provider asks the clients (modules) to sign up again. Happens when a new client has signed up.
Inactive	The configuration provider is not active on the device.
Disabled	The configuration provider is disabled because an error has occurred.

13.4.2 Reading out the number of loaded client (module) configurations

The value is valid since the last device start-up.









Do the following:

- Go to the **CONFIGURATION** view.
-  **General settings**
-  Confirm to access the **Parameter** view.
-  Go to the **DIAGNOSTICS** view.
-  **Configuration provider** -----> 
-  **Number of loaded client configurations** -----> 
-  Go back to the parent menu.

13.4.3 Reading out the number of reconfigured clients (modules)

The value is valid since the last device start-up.



Do the following:





- Go to the **CONFIGURATION** view.
-  **General settings**
-  Confirm to access the **Parameter** view.
-  Go to the **DIAGNOSTICS** view.
-  **Configuration provider** -----> 
-  **Number of reconfigured clients** -----> 
-  Go back to the parent menu.

13.4.4 Reading out the number of managed modules

The value is valid since the last device start-up.

Do the following:









- Go to the **CONFIGURATION** view.
-  **General settings**
-  Confirm to access the **Parameter** view.
-  Go to the **DIAGNOSTICS** view.

-  **Configuration provider** -----> 
-  **Number of managed devices** -----> 
-  Go back to the parent menu.

13.4.5 Reading out the number of missing modules

The value is valid since the last device start-up.









Do the following:

- Go to the **CONFIGURATION** view.
-  **General settings**
-  Confirm to access the **Parameter** view.
-  Go to the **DIAGNOSTICS** view.
-  **Configuration provider** -----> 
-  **Number of missing devices** -----> 
-  Go back to the parent menu.

13.4.6 Reading out the number of failed configuration loads

The value is valid since the last device start-up.

Do the following:

- Go to the **CONFIGURATION** view.
-  **General settings**
-  Confirm to access the **Parameter** view.
-  Go to the **DIAGNOSTICS** view.
-  **Configuration provider** -----> 
-  **Number of failed configuration loads** -----> 
-  Go back to the parent menu.

13.4.7 Reading out the number of failed reconfigurations

The value is valid since the last device start-up.

Do the following:

→ Go to the **CONFIGURATION** view.

→  **General settings**

→  Confirm to access the **Parameter** view.

→  Go to the **DIAGNOSTICS** view.

→  **Configuration provider** -----> 

→  **Number of failed reconfigurations** -----> 

→  Go back to the parent menu.

13.4.8 Erasing the configuration data of a single module

This function is only available on the PC software Bürkert Communicator.

If you want to replace the configuration data stored on the configuration memory by the current configuration data of each module, do the following:

Do the following:

→ **General settings** -----> **DIAGNOSTICS** -----> **Configuration provider** -----> **Managed devices**

→ Click **Next** to go through the modules which are managed by the configuration provider.

→ When the module whose data must be erased is displayed, check the box **Erase configuration of client**

→ To erase the configuration data of the selected modules, click **Finish**.

 The current configuration data of the selected modules is stored on the configuration memory.

14 GENERAL SETTINGS – MAINTENANCE









14.1 User levels of the menu items

Menu item of the General settings – Maintenance menu	Minimum user level
Device information	Basic user
Reset device	Installer

14.2 Reading out some device information









14.2.1 Reading out the displayed name of the device

To read out the displayed name of the device, do the following:

- Go to the **CONFIGURATION** view.
-  **General settings**
-  Confirm to access the **Parameter** view.
-  Go to the **MAINTENANCE** view.
-  **Device information** -----> 
-  **Displayed name** -----> 
-  Go back to the parent menu.









14.2.2 Reading out the article number of the device

To read out the article number of the device, do the following:

- Go to the **CONFIGURATION** view.
-  **General settings**
-  Confirm to access the **Parameter** view.
-  Go to the **MAINTENANCE** view.
-  **Device information** -----> 
-  **Ident. number** -----> 
-  Go back to the parent menu.









14.2.3 Reading out the serial number of the device

To read out the serial number of the device, do the following:

- Go to the **CONFIGURATION** view.
-  **General settings**
-  Confirm to access the **Parameter** view.
-  Go to the **MAINTENANCE** view.
-  **Device information** ----- 
-  **Serial number** ----- 
-  Go back to the parent menu.









14.2.4 Reading out the article number of the device software

To read out the article number of the device software, do the following:

- Go to the **CONFIGURATION** view.
-  **General settings**
-  Confirm to access the **Parameter** view.
-  Go to the **MAINTENANCE** view.
-  **Device information** ----- 
-  **Software ident. number** ----- 
-  Go back to the parent menu.









14.2.5 Reading out the version number of the device software

To read out the version number of the device software, do the following:

- Go to the **CONFIGURATION** view.
-  **General settings**
-  Confirm to access the **Parameter** view.
-  Go to the **MAINTENANCE** view.
-  **Device information** ----- 
-  **Software version** ----- 
-  Go back to the parent menu.









14.2.6 Reading out the version number of the büS software

To read out the version number of the büS software, do the following:

- Go to the **CONFIGURATION** view.
-  **General settings**
-  Confirm to access the **Parameter** view.
-  Go to the **MAINTENANCE** view.
-  **Device information** ----- 
-  **büS version** ----- 
-  Go back to the parent menu.









14.2.7 Reading out the version number of the device hardware

To read out the version number of the device hardware, do the following:

- Go to the **CONFIGURATION** view.
-  **General settings**
-  Confirm to access the **Parameter** view.
-  Go to the **MAINTENANCE** view.
-  **Device information** ----- 
-  **Hardware version** ----- 
-  Go back to the parent menu.









14.2.8 Reading out the Type number of the device

To read out the Type number of the device, do the following:

- Go to the **CONFIGURATION** view.
-  **General settings**
-  Confirm to access the **Parameter** view.
-  Go to the **MAINTENANCE** view.
-  **Device information** ----- 
-  **Product type code** ----- 
-  Go back to the parent menu.









14.2.9 Reading out the manufacturing date of the device

To read out the manufacturing date of the device, do the following:

- Go to the **CONFIGURATION** view.
-  **General settings**
-  Confirm to access the **Parameter** view.
-  Go to the **MAINTENANCE** view.
-  **Device information** ----- 
-  **Manufacture date** ----- 
-  Go back to the parent menu.

14.2.10 Reading out the version of the embedded eds file

To read out the version of the embedded eds file, do the following:

- Go to the **CONFIGURATION** view.
-  **General settings**
-  Confirm to access the **Parameter** view.
-  Go to the **MAINTENANCE** view.
-  **Device information** ----- 
-  **eds version** ----- 
-  Go back to the parent menu.

The content of the eds file is described in the related supplement available at country.burkert.com.

14.3 Resetting the device

WARNING







Risk of injury due to non-conforming adjustment.

Non-conforming adjustment could lead to injuries and damage the device and its surroundings.

- ▶ The operators in charge of adjustment must have read and understood the contents of the Operating Instructions.
- ▶ In particular, observe the safety recommendations and intended use.
- ▶ The device/installation must only be adjusted by suitably trained staff.









14.3.1 Restarting the device

To restart the device, do the following:

- Go to the **CONFIGURATION** view.
-  **General settings**
-  Confirm to access the **Parameter** view.
-  Go to the **MAINTENANCE** view.
-  **Reset device** -----> 
-  **Restart** -----> 
- ✔ The device restarts.

14.3.2 Resetting the device to all its factory settings

To reset the device to all its factory settings, do the following:

- Go to the **CONFIGURATION** view.
-  **General settings**
-  Confirm to access the **Parameter** view.
-  Go to the **MAINTENANCE** view.
-  **Reset device** -----> 
-  **Reset to factory settings** ----->  ----->  to reset the device to all its factory settings.
- ✔ The device is reset to all its factory settings.
-  Acknowledge the displayed message.

14.3.3 Updating the menu configuration of the device

If the hardware configuration of the device has changed, update the configuration of the menu structure:

- To have access to the menu entries related to the new components.
- To remove the menu entries related to the removed components.
- To avoid that error messages are generated.

For example, if you disconnect the display module because it is not used and you replace it with a blind cover. In that case, updating of the device menu configuration must be done with the Bürkert Communicator software.

To update the menu configuration of the device, do the following:

→ Go to the **CONFIGURATION** view.

→  **General settings**

→  Confirm to access the **Parameter** view.

→  Go to the **MAINTENANCE** view.

→  **Scan device for extensions** -----> 

 If you confirm updating of the menu configuration, the device will restart several times.

→ ----->  to update the menu configuration of the device. The device is restarted several times.

 The menu configuration of the device is up-to-date.

Menu **SAW sensor** – **PARAMETER**

15	SAW SENSOR – PARAMETER.....	150
15.1	Safety instructions	150
15.2	User levels of the editable menu items.....	150
15.3	Default settings	150
15.4	Setting the parameters of the volume flow rate	151
15.4.1	Giving a user defined name to the measured volume flow rate	151
15.4.2	Activating the damping of the volume flow rate values and choosing a predefined damping level.....	151
15.4.3	Activating a user-defined damping of the volume flow rate values	153
15.4.4	Deactivating the damping of the volume flow rate values.....	154
15.4.5	Activating the monitoring of the volume flow rate	154
15.4.6	Deactivating the monitoring of the volume flow rate	156
15.4.7	Changing the error limits, the warning limits and the hysteresis of the volume flow rate	157
15.4.8	Resetting the default values of the error limits, the warning limits and the hysteresis of the volume flow rate	158
15.4.9	Enabling the cut-off function of the volume flow rate.....	159
15.4.10	Changing the cut-off value of the volume flow rate	160
15.4.11	Disabling the cut-off function of the volume flow rate.....	160
15.4.12	Resetting the default values of all the volume flow rate parameters	161
15.5	Setting the parameters of the mass flow rate.....	162
15.5.1	Giving a user defined name to the measured mass flow rate	162
15.5.2	Activating the damping of the mass flow rate values and choosing a pre-defined damping level	162
15.5.3	Activating a user-defined damping of the mass flow rate values	165
15.5.4	Deactivating the damping of the mass flow rate values.....	166
15.5.5	Activating the monitoring of the mass flow rate	166
15.5.6	Deactivating the monitoring of the mass flow rate	168
15.5.7	Changing the error limits, the warning limits and the hysteresis of the mass flow rate.....	169
15.5.8	Resetting the default values of the error limits, the warning limits and the hysteresis of the mass flow rate	169
15.5.9	Enabling the cut-off function of the mass flow rate	170
15.5.10	Changing the cut-off value of the mass flow rate	171
15.5.11	Disabling the cut-off function of the mass flow rate.....	172
15.5.12	Resetting the default values of all the mass flow rate parameters	172

MAN 1000273158 EN Version: M Status: RL (released | freigegeben) printed: 22.06.2022

15.6	Setting the parameters of the liquid temperature.....	173
15.6.1	Giving a user defined name to the measured liquid temperature	173
15.6.2	Activating the damping of the liquid temperature values and choosing a predefined damping level.....	173
15.6.3	Activating a user-defined damping of the liquid temperature values	175
15.6.4	Deactivating the damping of the liquid temperature values.....	176
15.6.5	Activating the monitoring of the liquid temperature	176
15.6.6	Deactivating the monitoring of the liquid temperature	177
15.6.7	Changing the error limits, the warning limits and the hysteresis of the liquid temperature.....	178
15.6.8	Resetting the default values of the error limits, the warning limits and the hysteresis of the liquid temperature	178
15.6.9	Resetting the default values of all the liquid temperature parameters	179
15.7	Setting the parameters of the liquid concentration.....	180
15.7.1	Giving a user defined name to the measured liquid concentration	180
15.7.2	Selecting the liquid concentration type.....	180
15.7.3	Activating the damping of the liquid concentration values and choosing a predefined damping level.....	181
15.7.4	Activating a user-defined damping of the liquid concentration values	182
15.7.5	Deactivating the damping of the liquid concentration values	183
15.7.6	Activating the monitoring of the liquid concentration.....	183
15.7.7	Deactivating the monitoring of the liquid concentration	184
15.7.8	Changing the error limits, the warning limits and the hysteresis of the liquid concentration.....	185
15.7.9	Resetting the default values of the error limits, the warning limits and the hysteresis of the liquid concentration.....	186
15.7.10	Resetting the default values of all the liquid concentration parameters.....	186
15.8	Setting the parameters of the liquid velocity	187
15.8.1	Giving a user defined name to the measured liquid velocity.....	187
15.8.2	Activating the damping of the liquid velocity values and choosing a predefined damping level	187
15.8.3	Activating a user-defined damping of the liquid velocity values.....	189
15.8.4	Deactivating the damping of the liquid velocity values	190
15.8.5	Activating the monitoring of the liquid velocity	190
15.8.6	Deactivating the monitoring of the liquid velocity.....	191
15.8.7	Changing the error limits, the warning limits and the hysteresis of the liquid velocity	192
15.8.8	Resetting the default values of the error limits, the warning limits and the hysteresis of the liquid velocity.....	192
15.8.9	Resetting the default values of all the liquid velocity parameters.....	193

- 15.9 Setting the parameters of the liquid density..... 194
 - 15.9.1 Giving a user defined name to the measured liquid density 194
 - 15.9.2 Activating the damping of the liquid density values and choosing a pre-defined damping level 194
 - 15.9.3 Activating a user-defined damping of the liquid density values 196
 - 15.9.4 Deactivating the damping of the liquid density values 197
 - 15.9.5 Activating the monitoring of the liquid density 197
 - 15.9.6 Deactivating the monitoring of the liquid density 198
 - 15.9.7 Changing the error limits, the warning limits and the hysteresis of the liquid density 199
 - 15.9.8 Resetting the default values of the error limits, the warning limits and the hysteresis of the liquid density 199
 - 15.9.9 Setting the measurement mode of liquid density 200
 - 15.9.10 Resetting the default values of all the liquid density parameters 201
- 15.10 Setting the parameters of the volume totalizers..... 202
 - 15.10.1 Giving a user defined name to each volume totalizer 202
 - 15.10.2 Choosing the counting direction of each volume totalizer 202
 - 15.10.3 Activating the monitoring of each volume totalizer value 203
 - 15.10.4 Deactivating the monitoring of each volume totalizer 204
 - 15.10.5 Changing the error limits, the warning limits and the hysteresis of each volume totalizer 204
 - 15.10.6 Resetting the default values of the error limits, the warning limits and the hysteresis of each volume totalizer 205
 - 15.10.7 Enabling the user to start, stop or reset each volume totalizer 205
 - 15.10.8 Disabling the user to start, stop or reset each volume totalizer 206
 - 15.10.9 Starting each volume totalizer 206
 - 15.10.10 Stopping each volume totalizer 206
 - 15.10.11 Resetting each volume totalizer to a **Preset value** 207
 - 15.10.12 Changing the **Preset value** for a volume totalizer reset 207
 - 15.10.13 Resetting the overflow counter of each volume totalizer 208
 - 15.10.14 Resetting all the parameters of each volume totalizer to their default values 208
- 15.11 Setting the parameters of the mass totalizers..... 208
 - 15.11.1 Giving a user defined name to each mass totalizer 208
 - 15.11.2 Choosing the counting direction of each mass totalizer 209
 - 15.11.3 Activating the monitoring of each mass totalizer value 210
 - 15.11.4 Deactivating the monitoring of each mass totalizer 211
 - 15.11.5 Changing the error limits, the warning limits and the hysteresis of each mass totalizer 211

MAN 1000273158 EN Version: M Status: RL (released | freigegeben) printed: 22.06.2022

15.11.6	Resetting the default values of the error limits, the warning limits and the hysteresis of each mass totalizer.....	212
15.11.7	Enabling the user to start, stop or reset each mass totalizer.....	212
15.11.8	Disabling the user to start, stop or reset each mass totalizer.....	213
15.11.9	Starting each mass totalizer.....	213
15.11.10	Stopping each mass totalizer.....	213
15.11.11	Resetting each mass totalizer to a Preset value	214
15.11.12	Changing the Preset value for a mass totalizer reset.....	214
15.11.13	Resetting the overflow counter of each mass totalizer	215
15.11.14	Resetting all the parameters of each mass totalizer to their default values	215
15.12	Setting the parameters of the differentiation factor (optional feature)	216
15.12.1	What is the differentiation factor?.....	216
15.12.2	Giving a user defined name to the measured differentiation factor.....	216
15.12.3	Activating the damping of the differentiation factor values and choosing a predefined damping level	217
15.12.4	Activating a user-defined damping of the differentiation factor values	218
15.12.5	Deactivating the damping of the differentiation factor values	219
15.12.6	Activating the monitoring of the differentiation factor	220
15.12.7	Deactivating the monitoring of the differentiation factor.....	220
15.12.8	Changing the error limits, the warning limits and the hysteresis of the differentiation factor	221
15.12.9	Resetting the default values of the error limits, the warning limits and the hysteresis of the differentiation factor.....	222
15.12.10	Setting the temperature compensation to measure the differentiation factor.....	223
15.12.11	Setting the temperature compensation for a liquid other than water	223
15.12.12	Activating the temperature compensation for water	224
15.12.13	Resetting the default values of all the differentiation factor parameters.....	225
15.12.14	Use case example of the differentiation factor	225
15.13	Setting the parameters of the acoustic transmission factor (optional feature).....	226
15.13.1	What is the acoustic transmission factor?	226
15.13.2	Giving a user defined name to the measured acoustic transmission factor	226
15.13.3	Activating the damping of the values of the acoustic transmission factor and choosing a predefined damping level	227
15.13.4	Activating a user-defined damping of the values of the acoustic transmission factor	229
15.13.5	Deactivating the damping of the values of the acoustic transmission	230
15.13.6	Changing the error limits, the warning limits and the hysteresis of the acoustic transmission factor.....	230

- 15.13.7 Activating the monitoring of the acoustic transmission factor.....231
- 15.13.8 Deactivating the monitoring of the acoustic transmission factor232
- 15.13.9 Resetting the default values of the error limits, the warning limits and the hysteresis of the acoustic transmission factor..... 232
- 15.13.10 Resetting the default values of all the acoustic transmission factor parameters.233
- 15.14** Diagnostics: monitoring special events that occur in the process, on the sensor or on the electronics.....233
 - 15.14.1 Enabling the diagnostics for special events in the process237
 - 15.14.2 Disabling the diagnostics on a special event related to the process238
 - 15.14.3 Disabling the diagnostics on a special event occurring on the electronics238
 - 15.14.4 Enabling the diagnostics for special events occurring on the electronics239
 - 15.14.5 Disabling the diagnostics on a special event occurring on the sensor239
 - 15.14.6 Enabling the diagnostics for special events occurring on the sensor240
- 15.15** Getting as accurate measurements of the volume flow rate, the mass flow rate or the liquid velocity as possible241
 - 15.15.1 Activating the viscosity compensation for water-like liquids242
 - 15.15.2 Activating the compensation for a liquid with a constant viscosity.....242
 - 15.15.3 Activating the compensation for a liquid with a linear viscosity compensation curve243
 - 15.15.4 Activating the compensation for a liquid with a quadratic viscosity compensation curve244
 - 15.15.5 Activating the compensation for a liquid with an inverse quadratic viscosity compensation curve245
 - 15.15.6 Resetting the default values of the viscosity compensation parameters246
- 15.16** Setting the refresh time247
 - 15.16.1 Use case of the refresh time247
 - 15.16.2 Changing the refresh time247

MAN 1000273158 EN Version: M Status: RL (released | freigegeben) printed: 22.06.2022

15 SAW SENSOR – PARAMETER

15.1 Safety instructions



WARNING

Risk of injury due to non-conforming adjustment.

Non-conforming adjustment could lead to injuries and damage the device and its surroundings.

- ▶ The operators in charge of adjustment must have read and understood the contents of the Operating Instructions.
- ▶ In particular, observe the safety recommendations and intended use.
- ▶ The device/installation must only be adjusted by suitably trained staff.

15.2 User levels of the editable menu items

Menu item of the SAW sensor – Parameter menu	Minimum user level
Stand. meas. values (standard measurement values)	Advanced user
Add. meas. values (additional measurement values)	
Diag. events (diagnostics events)	
Refresh time	Installer

15.3 Default settings

You can find the default settings of the device in the CANopen supplement for the Type 8098 FLOWave L at country.burkert.com.

→ Before making any changes to the settings, use the Bürkert Communicator software to print a pdf file with all the default settings of the device.

15.4 Setting the parameters of the volume flow rate

15.4.1 Giving a user defined name to the measured volume flow rate

The name is used to identify the process value in the user defined views and in all the menus where the process value is displayed (for example in the **Outputs** menu).



By default, the name associated to the measured volume flow rate is **Volume flow**.

To add a user defined name to the default name, do the following:

→ Go to the **CONFIGURATION** view.

→  **SAW sensor**

→  Confirm to access the **Parameter** view.

→  **Stand. meas. values** -----> 

→  **Volume flow** -----> 

→  **Value name** -----> 

→    Enter the name by selecting and confirming each character. The name can have up to 19 characters.

→   **OK**

→  Save the name.

 The name is changed.

15.4.2 Activating the damping of the volume flow rate values and choosing a predefined damping level

The damping makes it possible to damp the fluctuations of the measured values of the volume flow rate:

- on the display,
- on the totalizers,
- on the outputs. The damping set for an analog output comes in addition to the damping of the volume flow.

The damping is not applied to the new measured value, if the 2 following conditions are met:

- a **Low**, **Medium** or **High** damping level is active,
- and the variation between 2 values that are measured one after the other is higher than 30 % (for example when charging the pipe or stopping the flow).

By default, the measured volume flow rate values are damped with the level **Medium**.

The **Low** damping level or no damping at all (**None**) are suited for applications/processes that need fast response times.

The **Medium** damping level or the **High** damping level are suited if the volume flow rate values change slowly.

→ As an alternative to the 3 predefined damping levels **Low**, **Medium** or **High**, you can set your own damping parameters. See chapter 15.4.3.

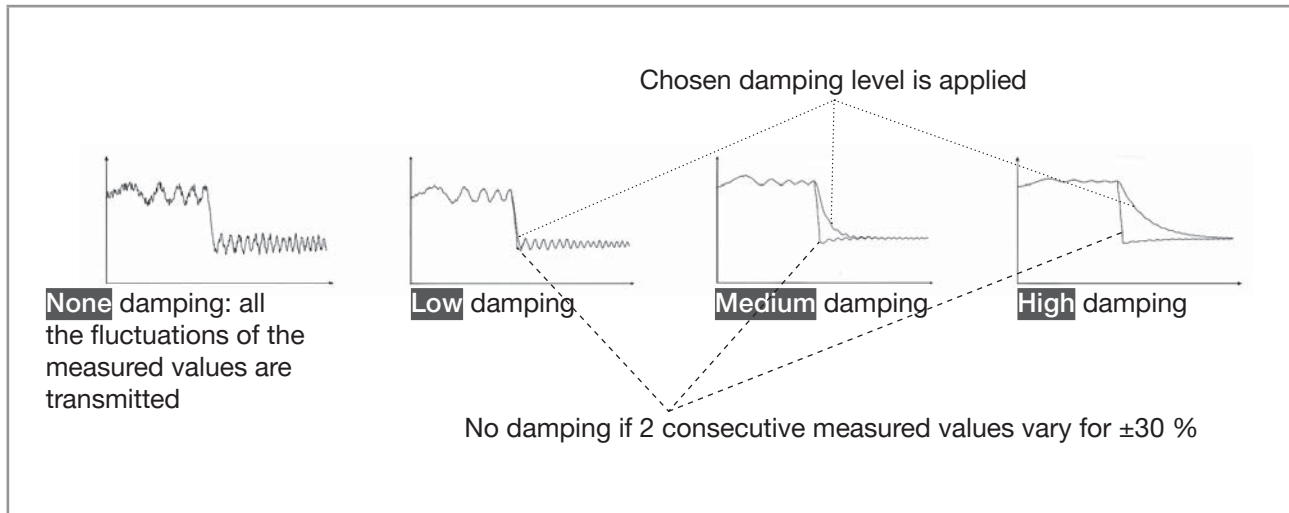

Fig. 51: Operation of the available damping levels

Table 24: Response times (10 %...90 %) of the damping levels for the volume flow rate measurements

Damping level	Response time
None	<ul style="list-style-type: none"> • 5 s if the Refresh time is set to Long • < 0.5 s if the Refresh time is set to Short or Very short.
Low	1 s
Medium	10 s
High	30 s
Special	User-defined Response time : see chapter 15.4.3

To set a predefined damping level of the measured volume flow rate values, do the following:

→ Go to the **CONFIGURATION** view.

→ **SAW sensor**

→ Confirm to access the **Parameter** view.

→ **Stand. meas. values**

→ **Volume flow**

→ **Damping** → The **Current settings** are displayed

→ Choose a damping level between **Low**, **Medium** and **High** → The **New settings** are displayed.

→ Save.

The damping of the volume flow rate values is active and a predefined damping level is chosen.

15.4.3 Activating a user-defined damping of the volume flow rate values

The damping makes it possible to damp the fluctuations of the measured values of the volume flow rate:

- on the display,
- on the totalizers,
- on the outputs. The damping set for an analog output comes in addition to the damping of the volume flow.

By default, the measured volume flow rate values are damped with the level **Medium**.

To damp the fluctuations of the measured values, you can:

- either choose 1 of the 3 predefined damping levels: **Low**, **Medium** or **High**. See chapter 15.4.2.
- Or you can set your own damping parameters with the **Special** damping.

With the **Special** damping, you can set 2 parameters:

- a user-defined **Response time** in seconds,
- the **Jump threshold**, i.e. a user-defined percentage. If 2 consecutive measured values vary for \pm the percentage, no damping is applied to the second measured value.

To set your own damping parameters of the measured volume flow rate values, do the following:

→ Go to the **CONFIGURATION** view.

→  **SAW sensor**

→  Confirm to access the **Parameter** view.

→  **Stand. meas. values** -----> 

→  **Volume flow** -----> 

→  **Damping** ----->  -----> The **Current settings** are displayed -----> 

→  **Special** -----> 

→  Set the value of the **Response time** -----> 

→  Choose if the **Jump threshold** is enabled or disabled -----> 

→  If the **Jump threshold** is enabled, set the value.

→  -----> The **New settings** are displayed ----->  Save.

 The special damping of the volume flow rate values is active.

15.4.4 Deactivating the damping of the volume flow rate values

If the damping of the volume flow rate values is active, do the following to deactivate it:

→ Go to the **CONFIGURATION** view.

→  **SAW sensor**

→  Confirm to access the **Parameter** view.

→  **Stand. meas. values** -----> 

→  **Volume flow** -----> 

→  **Damping** ----->  -----> The **Current settings** are displayed -----> 

→  Choose **None** ----->  -----> The **New settings** are displayed.

→  Save.

 The damping of the volume flow rate values is inactive.

15.4.5 Activating the monitoring of the volume flow rate

Because of a malfunction in the process or in the volume flow rate sensor, the measured volume flow rate value can be too high or too low.

A monitored value can be:

- in the normal operating range.
- in the warning range,
- in the error range.

You can set 4 limit values: 2 error limits and 2 warning limits.

→ To set the limit values, see chapter [15.4.7 Changing the error limits, the warning limits and the hysteresis of the volume flow rate.](#)

[Fig. 52](#) explains how the device reacts when the monitored value enters in another range (for example, from the normal range into the warning range). The reaction time depends on the hysteresis value and whether the monitored value increases or decreases.

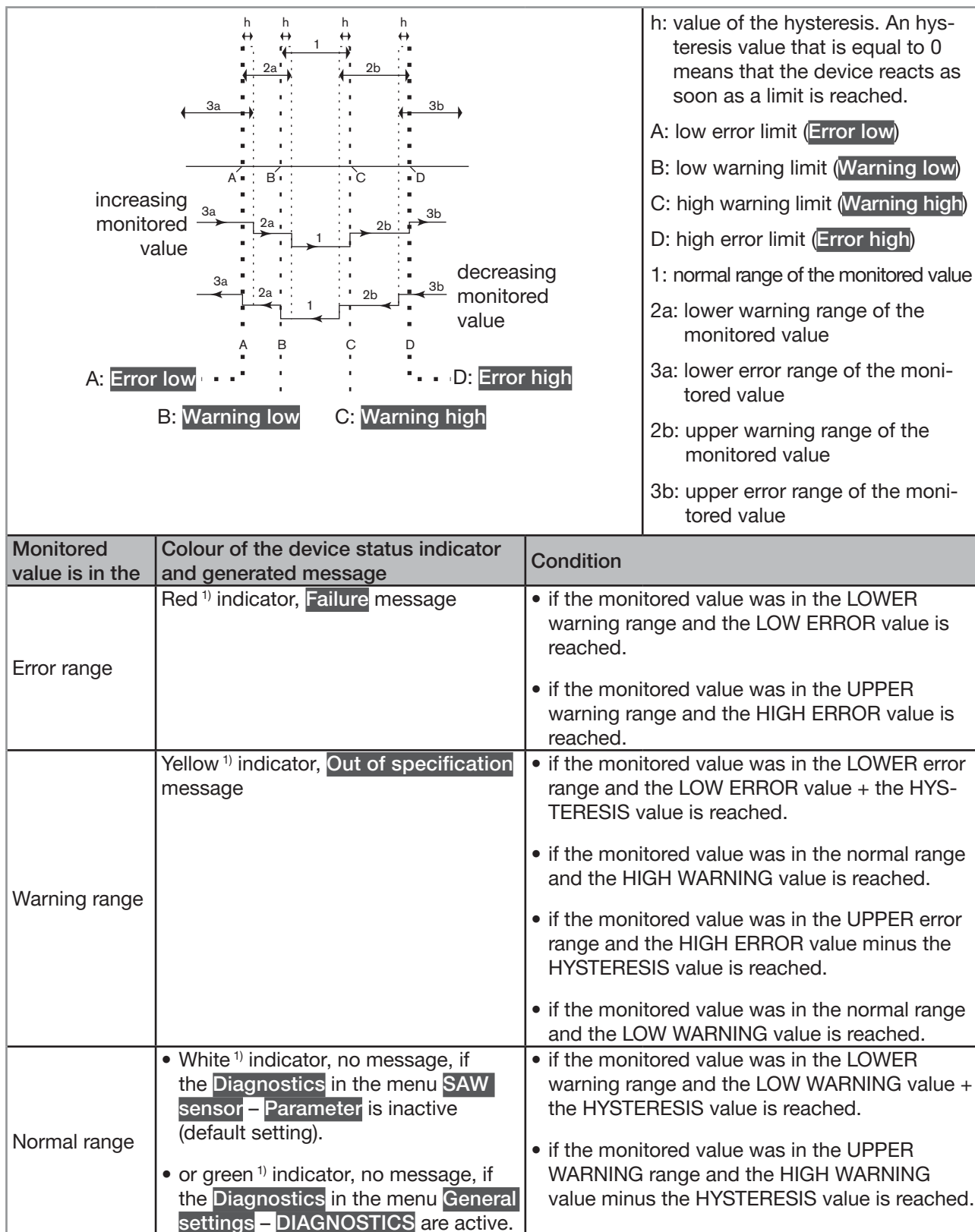

Fig. 52: Operating principle of the monitoring with an hysteresis

¹⁾ If the operating mode of the device status indicator is set to NAMUR. See chapter 12.4.

By default, the monitoring of the volume flow rate is disabled, and the diagnostics are all disabled.

To activate the monitoring of the volume flow rate, do the following:

→ Go to the **CONFIGURATION** view.

→  **SAW sensor**

→  Confirm to access the **Parameter** view.

→  **Stand. meas. values**   **Volume flow** 

→  **Limits** 

→  **Active** 

→  **Yes.**

→  **Save.**

 The monitoring of the volume flow rate is active and the device status will change depending on the limits that have been set.

→ You can configure the behaviour of an analogue output depending on the status of the device. See chapter [18.3.3](#).

→ You can configure a digital output to switch every time a specific event is generated. See chapter [18.5.1 Configuring a digital output as an on/off output](#).

→ To enable the monitoring, i.e. to be informed when the value of the volume flow rate is outside the normal range, enable the diagnostics. See chapter [12.10 Activating the diagnostics function](#).

15.4.6 Deactivating the monitoring of the volume flow rate

By default, the volume flow rate values are not monitored.

But if the monitoring of the volume flow rate is active, do the following to deactivate it:

→ Go to the **CONFIGURATION** view.

→  **SAW sensor**

→  Confirm to access the **Parameter** view.

→  **Stand. meas. values**   **Volume flow** 

→  **Limits** 

→  **Active** 

→  **No.**

→  **Save.**

 The monitoring of the volume flow rate is inactive.

15.4.7 Changing the error limits, the warning limits and the hysteresis of the volume flow rate

To change the error limits, the warning limits and the hysteresis of the volume flow rate, do the following:

→ Go to the **CONFIGURATION** view.



→  **SAW sensor**



→  Confirm to access the **Parameter** view.



→  **Stand. meas. values** ----->  ----->  **Volume flow** -----> 



→  **Limits** -----> 

→  **Settings** ----->  -----> The **Current settings** are displayed -----> 

→   Set the high error limit -----> 

→   Set the low error limit -----> 

→   Set the high warning limit -----> 

→   Set the low warning limit -----> 

→   Set the hysteresis value ----->  -----> The **New settings** are displayed.

→  Save.













 The limit values and the hysteresis value are changed.

15.4.8 Resetting the default values of the error limits, the warning limits and the hysteresis of the volume flow rate

The default values of the error limits, the warning limits and the hysteresis of the volume flow rate depend on the DN of the measurement tube:

- high error value: maximum volume flow rate value authorized for the DN,
- low error value: opposite value of the high error value,
- high warning value: 80 % of the maximum volume flow rate value authorized for the DN,
- low warning value: opposite value of the high warning value,
- value of the hysteresis: 0.0 l/min.

To reset the default values of the error limits, the warning limits and the hysteresis of the volume flow rate, do the following:

- Go to the **CONFIGURATION** view.
-  **SAW sensor**
-  Confirm to access the **Parameter** view.
-  **Stand. meas. values** -----> 
-  **Volume flow** -----> 
-  **Limits** -----> 
-  **Reset to default** -----> 
-  Confirm.
- ✓ The limit values and the hysteresis value are reset.
-  Go back to the parent menu.

15.4.9 Enabling the cut-off function of the volume flow rate

If the absolute (and possibly damped, see chapter 15.4.2) measured volume flow rate is less than the cut-off value plus an hysteresis value, the volume flow rate value is set to 0:

- the display then shows a volume flow rate = 0.
- the outputs and the totalizers react as if the actual volume flow rate were equal to 0.

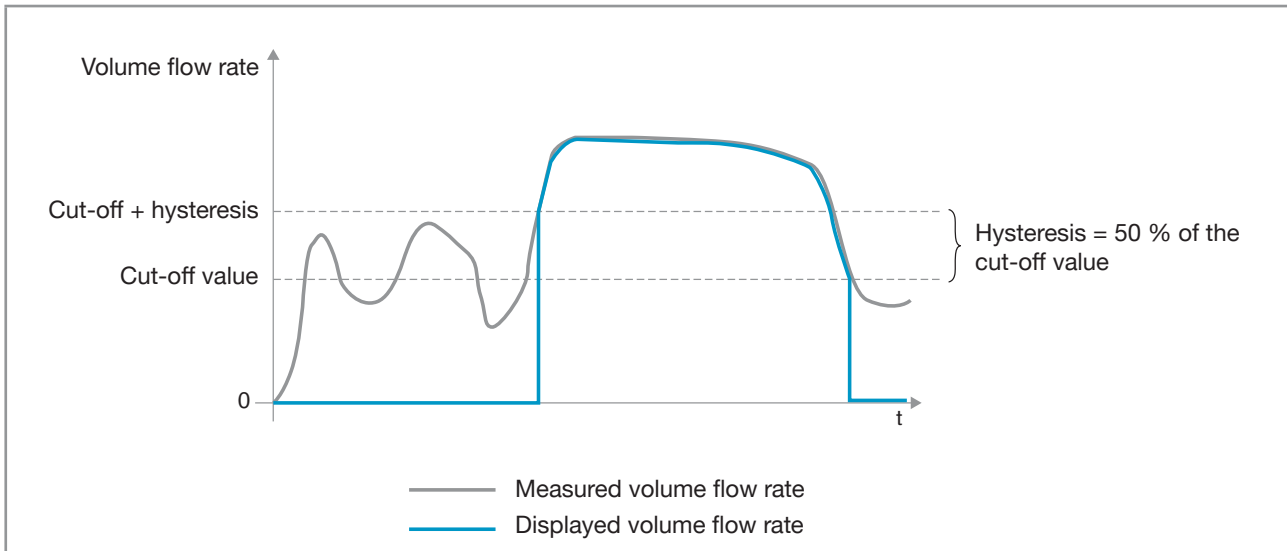

Fig. 53: Operation of the cut-off function

By default, the cut-off function is enabled.

If the cut-off function is disabled, do the following to enable it:

→ Go to the **CONFIGURATION** view.

→ **SAW sensor**

→ Confirm to access the **Parameter** view.

→ **Volume flow**

→ **Cut-off**

→ **Status**

→ **Enabled**













→ Save.

The cut-off function is enabled.

15.4.10 Changing the cut-off value of the volume flow rate













The default value of the cut-off volume flow rate is equal to 0.4 % of the full scale value. The full scale depends on the DN of the measurement tube.

To change the cut-off value of the volume flow rate, do the following:

- Go to the **CONFIGURATION** view.
-  **SAW sensor**
-  Confirm to access the **Parameter** view.
-  **Stand. meas. values** -----> 
-  **Volume flow** -----> 
-  **Cut-off** -----> 
-  **Value** -----> 
-   Set the cut-off value.
-  Save.
- ✔ The cut-off value of the volume flow rate is changed.











15.4.11 Disabling the cut-off function of the volume flow rate

If the cut-off function is enabled, do the following to disable it:

- Go to the **CONFIGURATION** view.
-  **SAW sensor**
-  Confirm to access the **Parameter** view.
-  **Stand. meas. values** -----> 
-  **Volume flow** -----> 
-  **Cut-off** -----> 
-  **Status** -----> 
-  **Disabled**
-  Save.
- ✔ The cut-off function is disabled.

15.4.12 Resetting the default values of all the volume flow rate parameters

To reset all the default values of the volume flow rate parameters, do the following:

- Go to the **CONFIGURATION** view.
-  **SAW sensor**
-  Confirm to access the **Parameter** view.
-  **Stand. meas. values** -----> 
-  **Volume flow** -----> 
-  **Reset to default** -----> 
-  Confirm.
- ✔ All the volume flow rate parameters are reset.
-  Go back to the parent menu.

15.5 Setting the parameters of the mass flow rate

15.5.1 Giving a user defined name to the measured mass flow rate

The name is used to identify the process value in the user defined views and in all the menus where the process value is displayed (for example in the **Outputs** menu).

By default, the name associated to the measured mass flow rate is **Mass flow**.

To add a user defined name to the default name, do the following:

→ Go to the **CONFIGURATION** view.



→  **SAW sensor**

→  Confirm to access the **Parameter** view.

→  **Stand. meas. values** -----> 

→  **Mass flow** -----> 

→  **Value name** -----> 

→    Enter the name by selecting and confirming each character. The name can have up to 19 characters.

→   **OK**

→  Save the name.

 The name is changed.

15.5.2 Activating the damping of the mass flow rate values and choosing a predefined damping level

The damping makes it possible to damp the fluctuations of the measured values of the mass flow rate:

- on the display,
- on the totalizers,
- on the outputs. The damping set for an analog output comes in addition to the damping of the mass flow rate.

The damping is not applied to the new measured value, if the 2 following conditions are met:

- a **Low**, **Medium** or **High** damping level is active,
- and the variation between 2 values that are measured one after the other is higher than 30 % (for example when charging the pipe or stopping the flow).

By default, the measured mass flow rate values are damped with the level **Medium**.

The **Low** damping level or no damping at all (**None**) are suited for applications/processes that need fast response times.

The **Medium** damping level or the **High** damping level are suited if the mass flow rate values change slowly.

→ As an alternative to the 3 predefined damping levels **Low**, **Medium** or **High**, you can set your own damping parameters. See chapter 15.5.3.

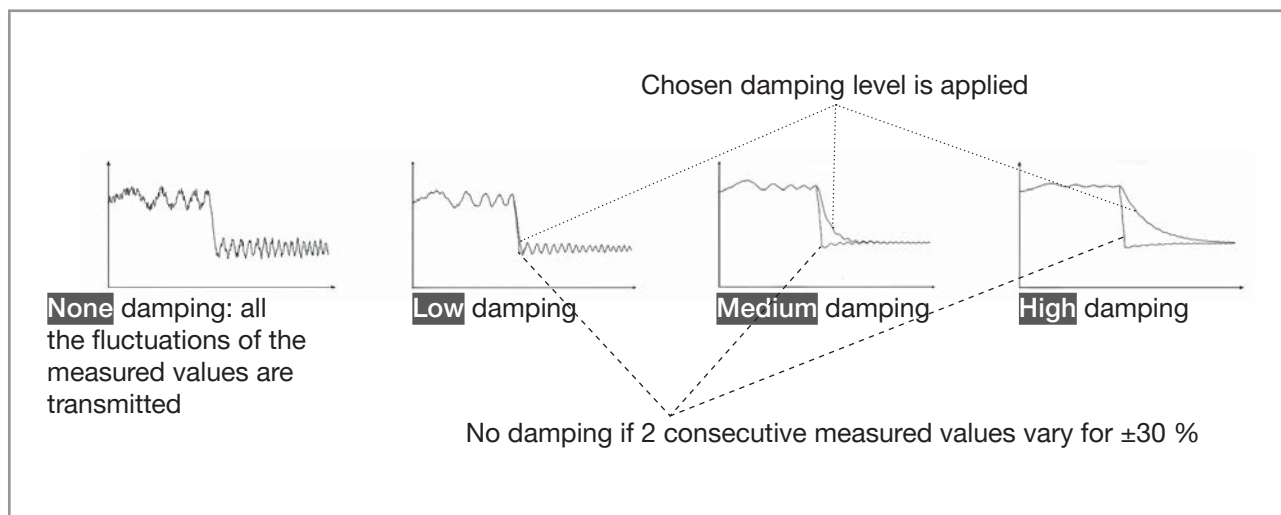

Fig. 54: Operation of the available damping levels

As mass flow rate damping comes in addition with density damping, the response time for mass flow rate measurement depends on both dampings.

Table 25: Response times (10 %...90 %) of the mass flow rate, depending on dampings level on density and mass flow rate

Damping level for density	Damping level for mass flow rate				
	None	Low	Medium	High	Special
None	<ul style="list-style-type: none"> • 5.5 s if the Refresh time is set to Long • 1.5 s if the Refresh time is set to Short or Very short 	<ul style="list-style-type: none"> • 1.5 s if the Refresh time is set to Long • 2 s if the Refresh time is set to Short or Very short 	<ul style="list-style-type: none"> • 10.5 s if the Refresh time is set to Long • 11 s if the Refresh time is set to Short or Very short 	<ul style="list-style-type: none"> • 30.5 s if the Refresh time is set to Long • 31.5 s if the Refresh time is set to Short or Very short 	<ul style="list-style-type: none"> • User defined Mass flow response time + 0.5 s if the Refresh time is set to Long • User defined Mass flow response time + 1 s if the Refresh time is set to Short or Very short
Low	<ul style="list-style-type: none"> • 8 s if the Refresh time is set to Long • 3.5 s if the Refresh time is set to Short or Very short 	• 4 s	• 13 s	• 33 s	• 3 s + User defined Mass flow response time

Damping level for density	Damping level for mass flow rate				
	None	Low	Medium	High	Special
Medium	<ul style="list-style-type: none"> 15 s if the Refresh time is set to Long 10.5 s if the Refresh time is set to Short or Very short 	<ul style="list-style-type: none"> 11 s 	<ul style="list-style-type: none"> 20 s 	<ul style="list-style-type: none"> 40 s 	<ul style="list-style-type: none"> 10 s + User defined Mass flow response time
High	<ul style="list-style-type: none"> 35 s if the Refresh time is set to Long 30.5 s if the Refresh time is set to Short or Very short 	<ul style="list-style-type: none"> 31 s 	<ul style="list-style-type: none"> 40 s 	<ul style="list-style-type: none"> 60 s 	<ul style="list-style-type: none"> 30 s + User defined Mass flow response time
Special	<ul style="list-style-type: none"> User-defined Density response time + 5 s if the Refresh time is set to Long User-defined Density response time + 1 s if the Refresh time is set to Short or Very short 	<ul style="list-style-type: none"> User-defined Density response time + 1 s 	<ul style="list-style-type: none"> User-defined Density response time + 10 s 	<ul style="list-style-type: none"> User-defined Density response time + 30 s 	<ul style="list-style-type: none"> User-defined Density response time + User defined Mass flow response time

To set a predefined damping level of the measured mass flow rate values, do the following:

→ Go to the **CONFIGURATION** view.

→  **SAW sensor**

→  Confirm to access the **Parameter** view.

→  **Stand. meas. values** -----> 

→  **Mass flow** -----> 

→  **Damping** ----->  -----> The **Current settings** are displayed -----> 

→  Choose a damping level between **Low**, **Medium** and **High** ----->  -----> The **New settings** are displayed.

→  Save.

 The damping of the mass flow rate values is active and a predefined damping level is chosen.

15.5.3 Activating a user-defined damping of the mass flow rate values

The damping makes it possible to damp the fluctuations of the measured values of the mass flow rate:

- on the display,
- on the totalizers,
- on the outputs. The damping set for an analog output comes in addition to the damping of the mass flow rate.

By default, the measured mass flow rate values are damped with the level **Medium**.

To damp the fluctuations of the measured values, you can:

- either choose 1 of the 3 predefined damping levels: **Low**, **Medium** or **High**. See chapter 15.5.2.
- Or you can set your own damping parameters with the **Special** damping.

With the **Special** damping, you can set 2 parameters:

- a user-defined **Response time** in seconds,
- the **Jump threshold**, i.e. a user-defined percentage. If 2 consecutive measured values vary for \pm the percentage, no damping is applied to the second measured value.

To set your own damping parameters of the measured mass flow rate values, do the following:

→ Go to the **CONFIGURATION** view.

→  **SAW sensor**

→  Confirm to access the **Parameter** view.

→  **Stand. meas. values** -----> 

→  **Mass flow** -----> 

→  **Damping** ----->  -----> The **Current settings** are displayed -----> 

→  **Special** -----> 

→  Set the value of the **Response time** -----> 

→  Choose if the **Jump threshold** is enabled or disabled -----> 

→  If the **Jump threshold** is enabled, set the value.

→  -----> The **New settings** are displayed ----->  Save.

 The special damping of the mass flow rate values is active.

15.5.4 Deactivating the damping of the mass flow rate values

If the damping of the mass flow rate values is active, do the following to deactivate it:

→ Go to the **CONFIGURATION** view.

→  **SAW sensor**

→  Confirm to access the **Parameter** view.

→  **Stand. meas. values** -----> 

→  **Mass flow** -----> 

→  **Damping** ----->  -----> The **Current settings** are displayed -----> 

→  Choose **None** ----->  -----> The **New settings** are displayed.

→  Save.

 The damping of the mass flow rate values is inactive.

15.5.5 Activating the monitoring of the mass flow rate

Because of a malfunction in the process or in the mass flow rate sensor, the measured mass flow rate value can be too high or too low.

A monitored value can be:

- in the normal operating range.
- in the warning range,
- in the error range.

You can set 4 limit values: 2 error limits and 2 warning limits.

→ To set the limit values, see chapter [15.5.7 Changing the error limits, the warning limits and the hysteresis of the mass flow rate.](#)

[Fig. 55](#) explains how the device reacts when the monitored value enters in another range (for example, from the normal range into the warning range). The reaction time depends on the hysteresis value and whether the monitored value increases or decreases.

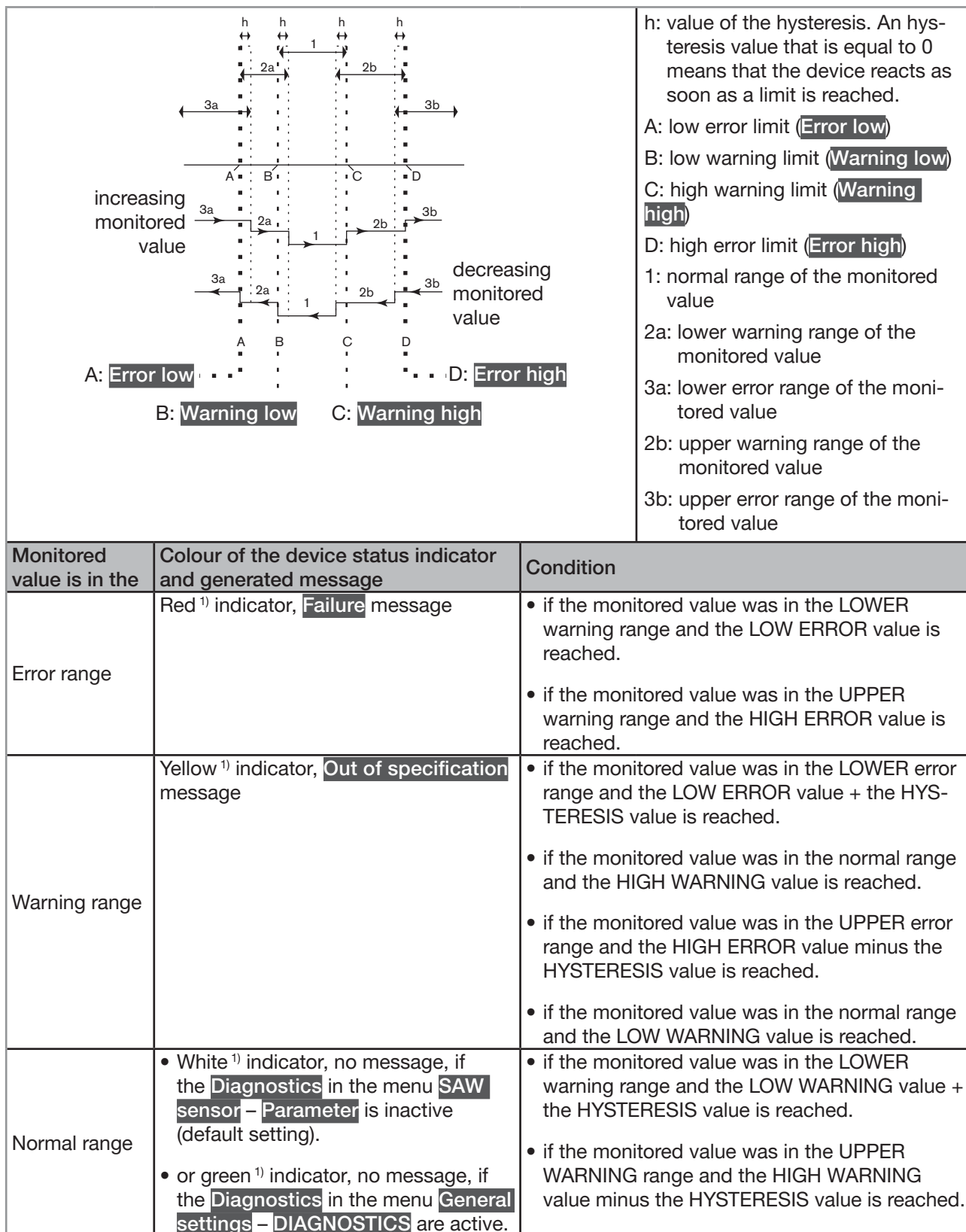

Fig. 55: Operating principle of the monitoring with an hysteresis

¹⁾ If the operating mode of the device status indicator is set to NAMUR. See chapter 12.4.

By default, the monitoring of the mass flow rate is disabled, and the diagnostics are all disabled.

To activate the monitoring of the mass flow rate, do the following:

→ Go to the **CONFIGURATION** view.

→  **SAW sensor**

→  Confirm to access the **Parameter** view.

→  **Stand. meas. values** ----->  ----->  **Mass flow** -----> 

→  **Limits** -----> 

→  **Active** -----> 

→  **Yes.**

→  **Save.**

 The monitoring of the mass flow rate is active and the device status will change depending on the limits that have been set.

→ You can configure the behaviour of an analogue output depending on the status of the device. See chapter [18.3.3](#).

→ You can configure a digital output to switch every time a specific event is generated. See chapter [18.5.1 Configuring a digital output as an on/off output](#).

→ To enable the monitoring, i.e. to be informed when the value of the mass flow rate is outside the normal range, enable the diagnostics. See chapter [12.10 Activating the diagnostics function](#).

15.5.6 Deactivating the monitoring of the mass flow rate

By default, the mass flow rate values are not monitored.

But if the monitoring of the mass flow rate is active, do the following to deactivate it:

→ Go to the **CONFIGURATION** view.

→  **SAW sensor**

→  Confirm to access the **Parameter** view.

→  **Stand. meas. values** ----->  ----->  **Mass flow** -----> 

→  **Limits** -----> 

→  **Active** -----> 

→  **No.**

→  **Save.**

 The monitoring of the mass flow rate is inactive.

15.5.7 Changing the error limits, the warning limits and the hysteresis of the mass flow rate

To change the error limits, the warning limits and the hysteresis of the mass flow rate, do the following:

→ Go to the **CONFIGURATION** view.



→  **SAW sensor**



→  Confirm to access the **Parameter** view.



→  **Stand. meas. values** -----  -----  **Mass flow** ----- 

→  **Limits** ----- 

→  **Settings** -----  ----- The **Current settings** are displayed ----- 

→   Set the high error limit ----- 

→   Set the low error limit ----- 

→   Set the high warning limit ----- 

→   Set the low warning limit ----- 

→   Set the hysteresis value -----  ----- The **New settings** are displayed.

→  Save.

 The limit values and the hysteresis value are changed.

15.5.8 Resetting the default values of the error limits, the warning limits and the hysteresis of the mass flow rate

The default values of the error limits, the warning limits and the hysteresis of the mass flow rate depend on the DN of the measurement tube:

- high error value: maximum mass flow rate value authorized for the DN,
- low error value: opposite value of the high error value,
- high warning value: 80 % of the maximum mass flow rate value authorized for the DN,
- low warning value: opposite value of the high warning value,
- value of the hysteresis: 0.0 l/min.

To reset the default values of the error limits, the warning limits and the hysteresis of the mass flow rate, do the following:

→ Go to the **CONFIGURATION** view.

→  **SAW sensor**

→  Confirm to access the **Parameter** view.

- **Stand. meas. values** ----->
- **Mass flow** ----->
- **Limits** ----->
- **Reset to default** ----->
- Confirm.
- ✓ The limit values and the hysteresis value are reset.
- Go back to the parent menu.

15.5.9 Enabling the cut-off function of the mass flow rate

If the absolute (and possibly damped, see chapter 15.5.2) measured mass flow rate is less than the cut-off value plus an hysteresis value, the mass flow rate value is set to 0:

- the display then shows a mass flow rate = 0.
- the outputs and the totalizers react as if the actual mass flow rate were equal to 0.

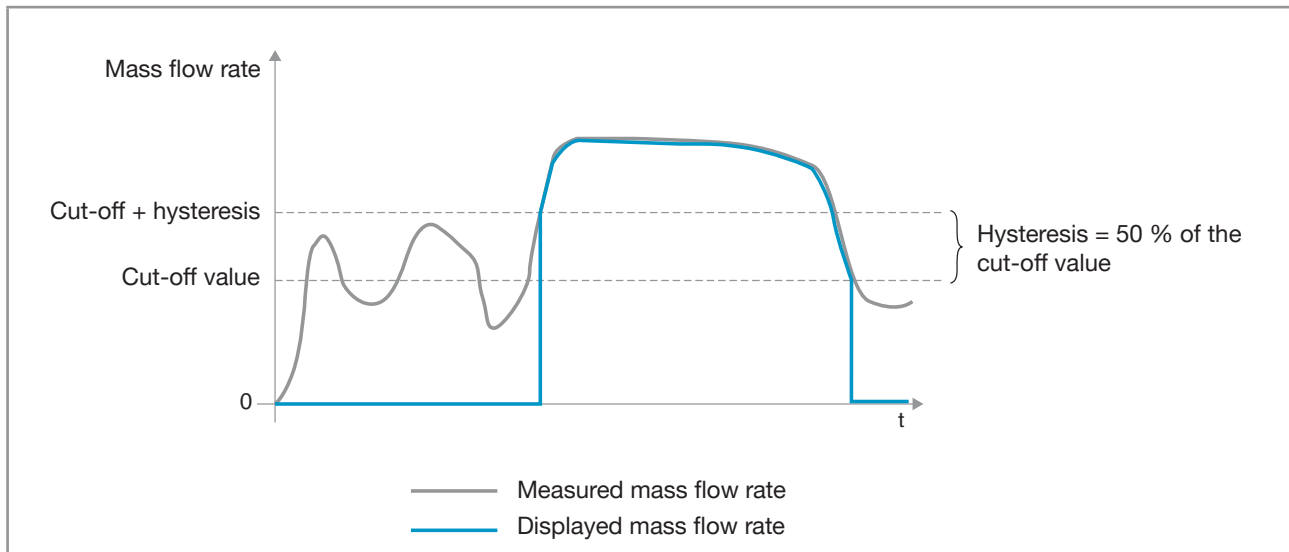

Fig. 56: Operation of the cut-off function

By default, the cut-off function is enabled.

If the cut-off function is disabled, do the following to enable it:

- Go to the **CONFIGURATION** view.
- **SAW sensor**
- Confirm to access the **Parameter** view.
- **Mass flow** ----->
- **Cut-off** ----->

→  **Status** -----> 

→  **Enabled**

→  Save.

 The cut-off function is enabled.

15.5.10 Changing the cut-off value of the mass flow rate

The default value of the cut-off mass flow rate is equal to 0.4 % of the full scale value. The full scale depends on the DN of the measurement tube.

To change the cut-off value of the mass flow rate, do the following:

→ Go to the **CONFIGURATION** view.

→  **SAW sensor**



→  Confirm to access the **Parameter** view.

→  **Stand. meas. values** -----> 

→  **Mass flow** -----> 

→  **Cut-off** -----> 

→  **Value** -----> 













→   Set the cut-off value.

→  Save.

 The cut-off value of the mass flow rate is changed.











15.5.11 Disabling the cut-off function of the mass flow rate

If the cut-off function is enabled, do the following to disable it:

- Go to the **CONFIGURATION** view.
-  **SAW sensor**
-  Confirm to access the **Parameter** view.
-  **Stand. meas. values** -----> 
-  **Mass flow** -----> 
-  **Cut-off** -----> 
-  **Status** -----> 
-  **Disabled**
-  Save.
-  The cut-off function is disabled.

15.5.12 Resetting the default values of all the mass flow rate parameters

To reset all the default values of the mass flow rate parameters, do the following:

- Go to the **CONFIGURATION** view.
-  **SAW sensor**
-  Confirm to access the **Parameter** view.
-  **Stand. meas. values** -----> 
-  **Mass flow** -----> 
-  **Reset to default** -----> 
-  Confirm.
-  All the mass flow rate parameters are reset.
-  Go back to the parent menu.

15.6 Setting the parameters of the liquid temperature

15.6.1 Giving a user defined name to the measured liquid temperature

The name is used to identify the process value in the user defined views and in all the menus where the process value is displayed (for example in the **Outputs** menu).

By default, the name associated to the measured liquid temperature is **Temperature**.

To add a user defined name to the default name, do the following:

→ Go to the **CONFIGURATION** view.

→  **SAW sensor**

→  Confirm to access the **Parameter** view.

→  **Stand. meas. values** -----> 

→  **Temperature** -----> 

→  **Value name** -----> 

→    Enter the name by selecting and confirming each character. The name can have up to 19 characters.

→   **OK**

→  Save the name.

 The name is changed.

15.6.2 Activating the damping of the liquid temperature values and choosing a predefined damping level

The damping makes it possible to damp the fluctuations of the measured values of the liquid temperature:

- on the display,
- on the outputs. The damping of the liquid temperature comes in addition to the damping set for each analog output (see chapter [18.3.2](#)).

The damping is not applied to the new measured value, if the 2 following conditions are met:

- a **Low**, **Medium** or **High** damping level is active,
- and the variation between 2 values that are measured one after the other is higher than 20 °C.

The refresh time, set in chapter [15.16](#), has no effect on the damping of the measured values.

By default, the measured liquid temperature values are not damped.

→ As an alternative to the 3 predefined damping levels **Low**, **Medium** or **High**, you can set your own damping parameters. See [15.6.3](#).

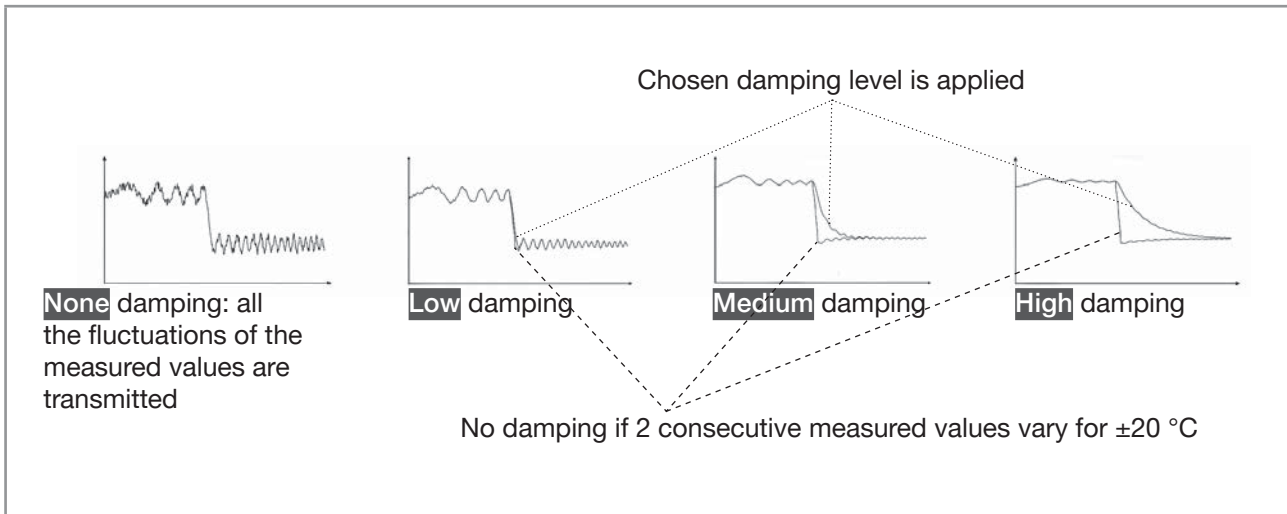

Fig. 57: Operation of the available damping levels

Table 26: Response times (10 %...90 %) of the damping levels for the liquid temperature measurements

Damping level	Response time
None	0 s
Low	1 s
Medium	10 s
High	30 s
Special	User-defined Response time : see chapter 15.6.3

To set a predefined damping level of the measured liquid temperature values, do the following:

→ Go to the **CONFIGURATION** view.

→ **SAW sensor**

→ Confirm to access the **Parameter** view.

→ **Stand. meas. values**

→ **Temperature**

→ **Damping** → The **Current settings** are displayed

→ Choose a damping level between **Low**, **Medium** and **High** → The **New settings** are displayed.

→ Save.

The damping of the liquid temperature values is active and a predefined damping level is chosen.

15.6.3 Activating a user-defined damping of the liquid temperature values

The damping makes it possible to damp the fluctuations of the measured values of the liquid temperature:

- on the display,
- on the outputs. The damping of the liquid temperature comes in addition to the damping set for each analog output (see chapter 18.3.2).

By default, the measured liquid temperature values are not damped.

To damp the fluctuations of the measured values, you can:

- either choose 1 of the 3 predefined damping levels: **Low**, **Medium** or **High**. See chapter 15.6.2.
- Or you can set your own damping parameters with the **Special** damping.

With the **Special** damping, you can set 2 parameters:

- a user-defined **Response time** in seconds,
- the **Jump threshold**, i.e. a user-defined temperature value. If 2 consecutive measured values vary for \pm the set temperature value, no damping is applied to the second measured value.

To set your own damping parameters of the measured liquid temperature values, do the following:

→ Go to the **CONFIGURATION** view.

→  **SAW sensor**

→  Confirm to access the **Parameter** view.

→  **Stand. meas. values** -----> 

→  **Temperature** -----> 

→  **Damping** ----->  -----> The **Current settings** are displayed -----> 

→  **Special** -----> 

→  Set the value of the **Response time** -----> 

→  Choose if the **Jump threshold** is enabled or disabled -----> 

→  If the **Jump threshold** is enabled, set the value.

→  -----> The **New settings** are displayed ----->  Save.

 The special damping of the liquid temperature values is active.

15.6.4 Deactivating the damping of the liquid temperature values

By default, the liquid temperature values are not damped.

But if the damping of the liquid temperature values is active, do the following to deactivate it:

→ Go to the **CONFIGURATION** view.

→  **SAW sensor**

→  Confirm to access the **Parameter** view.

→  **Stand. meas. values** -----> 

→  **Temperature** -----> 

→  **Damping** ----->  -----> The **Current settings** are displayed -----> 

→  Choose **None** ----->  -----> The **New settings** are displayed.

→  Save.

 The damping of the liquid temperature values is inactive.

15.6.5 Activating the monitoring of the liquid temperature



If the temperature sensor is defective, the monitoring of the liquid temperature has no effect. In that case:

- the display shows " — —".
- the message "**No temperature sensor detected**" is displayed.

Because of a malfunction in the process, the measured liquid temperature value can be too high or too low.

A monitored value can be:

- in the normal operating range.
- in the warning range,
- in the error range.

You can set 4 limit values: 2 error limits and 2 warning limits.

→ To set the limit values, see chapter [15.6.7 Changing the error limits, the warning limits and the hysteresis of the liquid temperature.](#)











Fig. 52 in chapter 15.4.5 explains how the device reacts when the monitored value enters in another range (for example, from the normal range into the warning range). The reaction time depends on the hysteresis value and if the monitored value increases or decreases.

By default, the monitoring of the liquid temperature and the diagnostics are all disabled.

To activate the monitoring of the liquid temperature, do the following:

→ Go to the **CONFIGURATION** view.

→  **SAW sensor**













-  Confirm to access the **Parameter** view.
-  **Stand. meas. values** -----> 
-  **Temperature** -----> 
-  **Limits** -----> 
-  **Active** -----> 
-  **Yes.**
-  Save.

 The monitoring of the liquid temperature is active and the device status will change depending on the limits that have been set.

- You can configure the behaviour of an analogue output depending on the status of the device. See chapter [18.3.3](#).
- You can configure a digital output to switch every time a specific event is generated. See chapter [18.5.1 Configuring a digital output as an on/off output](#).
- To enable the monitoring, i.e. to be informed when the value of the liquid temperature is outside the normal range, enable the diagnostics. See chapter [12.10 Activating the diagnostics function](#).

15.6.6 Deactivating the monitoring of the liquid temperature



























By default, the liquid temperature values are not monitored. If the monitoring of the liquid temperature is active, do the following to deactivate it:

- Go to the **CONFIGURATION** view.
-  **SAW sensor**
-  Confirm to access the **Parameter** view.
-  **Stand. meas. values** ----->  ----->  **Temperature** -----> 
-  **Limits** -----> 
-  **Active** -----> 
-  **No**
-  Save.

 The monitoring of the liquid temperature is inactive.

15.6.7 Changing the error limits, the warning limits and the hysteresis of the liquid temperature

To change the error limits, the warning limits and the hysteresis of the liquid temperature, do the following:

- Go to the **CONFIGURATION** view.
-  **SAW sensor**
-  Confirm to access the **Parameter** view.
-  **Stand. meas. values** -----> 
-  **Temperature** -----> 
-  **Limits** -----> 
-  **Settings** ----->  -----> The **Current settings** are displayed -----> 
-   Set the high error limit -----> 
-   Set the low error limit -----> 
-   Set the high warning limit -----> 
-   Set the low warning limit -----> 
-   Set the hysteresis value ----->  -----> The **New settings** are displayed.
-  Save.

 The limit values and the hysteresis value are changed.

15.6.8 Resetting the default values of the error limits, the warning limits and the hysteresis of the liquid temperature











The default values of the error limits, the warning limits and the hysteresis of the liquid temperature are the following:

- high error value: 150.0 °C,
- low error value: -20.0 °C,
- high warning value: 140.0 °C,
- low warning value: -10.0 °C,
- value of the hysteresis: 0.0 °C.

To reset the default values of the error limits, the warning limits and the hysteresis of the liquid temperature, do the following:











- Go to the **CONFIGURATION** view.

-  **SAW sensor**

-  Confirm to access the **Parameter** view.
-  **Stand. meas. values** -----> 
-  **Temperature** -----> 
-  **Limits** -----> 
-  **Reset to default** ----->  ----->  Confirm.
- ✔ The limit values and the hysteresis value are reset.
-  Go back to the parent menu.

15.6.9 Resetting the default values of all the liquid temperature parameters

To reset all the default values of the liquid temperature parameters, do the following:

- Go to the **CONFIGURATION** view.
-  **SAW sensor**
-  Confirm to access the **Parameter** view.
-  **Stand. meas. values** -----> 
-  **Temperature** -----> 
-  **Reset to default** -----> 
-  Confirm.
- ✔ All the liquid temperature parameters are reset.
-  Go back to the parent menu.

15.7 Setting the parameters of the liquid concentration

15.7.1 Giving a user defined name to the measured liquid concentration

The name is used to identify the process value in the user defined views and in all the menus where the process value is displayed (for example in the **Outputs** menu).

By default, the names associated to the measured liquid concentration are **Concentration 1** and **Concentration 2**.

To add a user defined name to the default name, do the following:

→ Go to the **CONFIGURATION** view.



→  **SAW sensor**

→  Confirm to access the **Parameter** view.

→  **Add. meas. values** -----> 

→  **Concentration 1** or **Concentration 2** -----> 

→  **Value name** -----> 

→    Enter the name by selecting and confirming each character. The name can have up to 19 characters.

→   **OK**

→  Save the name.

 The name is changed.

15.7.2 Selecting the liquid concentration type

To select the liquid concentration type, do the following:

→ Go to the **CONFIGURATION** view.

→  **SAW sensor**



→  Confirm to access the **Parameter** view.

→  **Add. meas. values** -----> 

→  **Concentration 1** or **Concentration 2** -----> 

→  **Concentration law** ----->  -----> The **Current settings** (liquid and unit) are displayed.

→    Choose the expected concentration law into the choice given by the device.

→    Choose the expected unit into the choice given by the device.
-----> The **New settings** are displayed.

→  Acknowledge the message to go back to the parent menu.

15.7.3 Activating the damping of the liquid concentration values and choosing a predefined damping level

The damping makes it possible to damp the fluctuations of the measured values of the liquid concentration:

- on the display,
- on the outputs. The damping of the liquid concentration comes in addition to the damping set for each analog output (see chapter 18.3.2).

The damping is not applied to the new measured value, if the 2 following conditions are met:

- a **Low**, **Medium** or **High** damping level is active,
- and the variation between 2 values that are measured one after the other is higher than 20 °C.

The refresh time, set in chapter 15.16, has no effect on the damping of the measured values.

By default, the measured liquid concentration values are not damped.

→ As an alternative to the 3 predefined damping levels **Low**, **Medium** or **High**, you can set your own damping parameters. See 15.7.4.

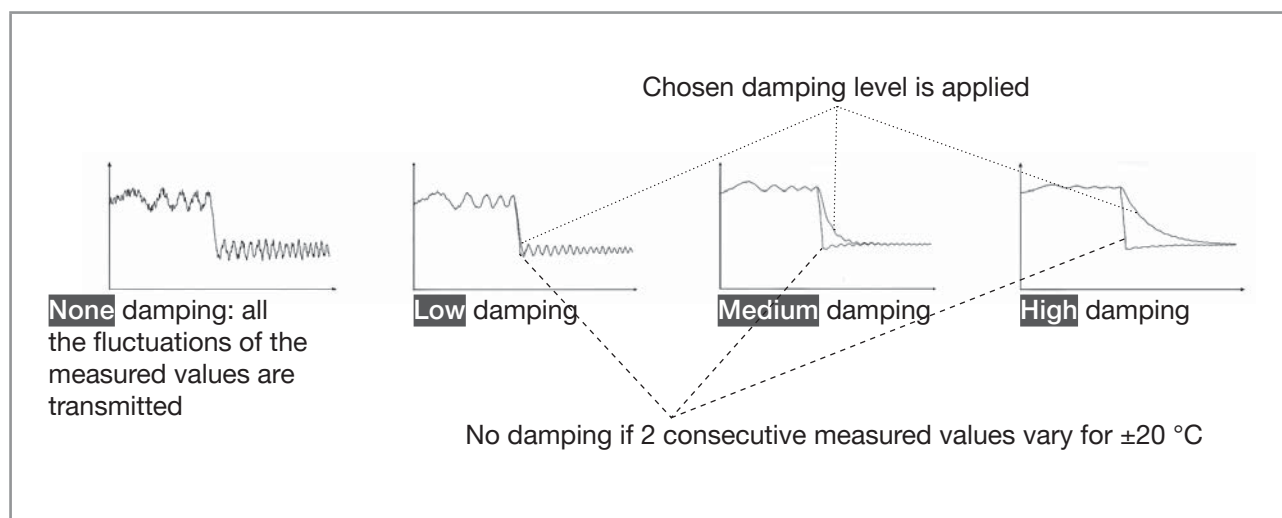

Fig. 58: Operation of the available damping levels

Table 27: Response times (10 %...90 %) of the damping levels for the liquid concentration measurements

Damping level	Response time
None	0 s
Low	1 s
Medium	10 s
High	30 s
Special	User-defined Response time : see chapter 15.6.3

To set a predefined damping level of a measured liquid concentration value, do the following:

→ Go to the **CONFIGURATION** view.

→ **SAW sensor**

→ Confirm to access the **Parameter** view.

→ **Add. meas. values** ----->

- **Concentration 1** or **Concentration 2** ----->
- **Damping** -----> -----> The **Current settings** are displayed ----->
- Choose a damping level between **Low**, **Medium** and **High** ----->
-----> The **New settings** are displayed.
- Save.

The damping of the selected liquid concentration value is active and a predefined damping level is chosen.

15.7.4 Activating a user-defined damping of the liquid concentration values

The damping makes it possible to damp the fluctuations of the measured values of the liquid concentration:

- on the display,
- on the outputs. The damping of the liquid concentration comes in addition to the damping set for each analog output (see chapter 18.3.2).

By default, the measured liquid concentration values are not damped.

To damp the fluctuations of the measured values, you can:

- either choose 1 of the 3 predefined damping levels: **Low**, **Medium** or **High**. See chapter 15.7.3.
- Or you can set your own damping parameters with the **Special** damping.

With the **Special** damping, you can set 2 parameters:

- a user-defined **Response time** in seconds,
- the **Jump threshold**, i.e. a user-defined liquid concentration value. If 2 consecutive measured values vary for \pm the set liquid concentration value, no damping is applied to the second measured value.

To set your own damping parameters of a measured liquid concentration value, do the following:

- Go to the **CONFIGURATION** view.
- **SAW sensor**
- Confirm to access the **Parameter** view.
- **Add. meas. values** ----->
- **Concentration 1** or **Concentration 2** ----->
- **Damping** -----> -----> The **Current settings** are displayed ----->
- **Special** ----->
- Set the value of the **Response time** ----->
- Choose if the **Jump threshold** is enabled or disabled ----->
- If the **Jump threshold** is enabled, set the value.
- -----> The **New settings** are displayed -----> Save.

The special damping of the liquid concentration value is active.

15.7.5 Deactivating the damping of the liquid concentration values

By default, the liquid concentration values are not damped.

But if the damping of a liquid concentration value (**Concentration 1** or **Concentration 2**) is active, do the following to deactivate it:

→ Go to the **CONFIGURATION** view.

→  **SAW sensor**

→  Confirm to access the **Parameter** view.

→  **Add. meas. values** -----> 

→  **Concentration 1** or **Concentration 2** -----> 

→  **Damping** ----->  -----> The **Current settings** are displayed -----> 

→  Choose **None** ----->  -----> The **New settings** are displayed.

→  Save.

 The damping of the liquid concentration value is inactive.

15.7.6 Activating the monitoring of the liquid concentration

Because of a malfunction in the process, the measured liquid concentration value can be too high or too low.

A monitored value can be:

- in the normal operating range.
- in the warning range,
- in the error range.

You can set 4 limit values: 2 error limits and 2 warning limits.

→ To set the limit values, see chapter [15.7.8 Changing the error limits, the warning limits and the hysteresis of the liquid concentration](#).

[Fig. 52](#) in [15.4.5](#) explains how the device reacts when the monitored value enters in another range (for example, from the normal range into the warning range). The reaction time depends on the hysteresis value and if the monitored value increases or decreases.

By default, the monitoring of the liquid concentration and the diagnostics are all disabled.

To activate the monitoring of a liquid concentration value, do the following:

→ Go to the **CONFIGURATION** view.

→  **SAW sensor**

→  Confirm to access the **Parameter** view.

→  **Add. meas. values** -----> 

- Concentration 1 or Concentration 2 ----->
- Limits ----->
- Active ----->
- Yes.
- Save.

The monitoring of the liquid concentration is active and the device status will change depending on the limits that have been set.

→ You can configure the behaviour of an analogue output depending on the status of the device. See chapter [18.3.3](#).

→ You can configure a digital output to switch every time a specific event is generated. See chapter [18.5.1 Configuring a digital output as an on/off output](#).

→ To enable the monitoring, i.e. to be informed when the value of the liquid concentration is outside the normal range, enable the diagnostics. See chapter [12.10 Activating the diagnostics function](#).

15.7.7 Deactivating the monitoring of the liquid concentration





























By default, the liquid concentration values are not monitored. If the monitoring of a liquid concentration value is active, do the following to deactivate it:

- Go to the **CONFIGURATION** view.
- SAW sensor
- Confirm to access the **Parameter** view.
- Add. meas. values ----->
- Concentration 1 or Concentration 2 ----->
- Limits ----->
- Active ----->
- No
- Save.

The monitoring of the liquid concentration is inactive.

15.7.8 Changing the error limits, the warning limits and the hysteresis of the liquid concentration

To change the error limits, the warning limits and the hysteresis of liquid concentration 1 or liquid concentration 2, do the following:

- Go to the **CONFIGURATION** view.
 -  **SAW sensor**
 -  Confirm to access the **Parameter** view.
 -  **Add. meas. values** -----> 
 -  **Concentration 1** or **Concentration 2** -----> 
 -  **Limits** -----> 
 -  **Settings** ----->  -----> The **Current settings** are displayed -----> 
 -   Set the high error limit -----> 
 -   Set the low error limit -----> 
 -   Set the high warning limit -----> 
 -   Set the low warning limit -----> 
 -   Set the hysteresis value ----->  -----> The **New settings** are displayed.
 -  Save.
-  The limit values and the hysteresis value are changed.

15.7.9 Resetting the default values of the error limits, the warning limits and the hysteresis of the liquid concentration

The default values of the error limits, the warning limits and the hysteresis of the liquid concentration are the following:

- high error value: 100 %,
- low error value: -0.01 %,
- high warning value: 100 %,
- low warning value: -0.01 %,
- value of the hysteresis: 0.0 °C.

To reset the default values of the error limits, the warning limits and the hysteresis of liquid concentration 1 or liquid concentration 2, do the following:

- Go to the **CONFIGURATION** view.
- **SAW sensor**
- Confirm to access the **Parameter** view.
- **Add. meas. values** ----->
- **Concentration 1** or **Concentration 2** ----->
- **Limits** ----->
- **Reset to default** -----> -----> **Confirm.**
- ✓ The limit values and the hysteresis value are reset.
- Go back to the parent menu.

15.7.10 Resetting the default values of all the liquid concentration parameters

To reset all the default values of the liquid concentration parameters, do the following:

- Go to the **CONFIGURATION** view.
- **SAW sensor**
- Confirm to access the **Parameter** view.
- **Add. meas. values** ----->
- **Concentration 1** or **Concentration 2** ----->
- **Reset to default** ----->
- **Confirm.**
- ✓ All parameters of the selected liquid concentration are reset.
- Go back to the parent menu.

15.8 Setting the parameters of the liquid velocity

15.8.1 Giving a user defined name to the measured liquid velocity

The name is used to identify the process value in the user defined views and in all the menus where the process value is displayed (for example in the **Outputs** menu).



By default, the name associated to the measured liquid velocity is **Liquid velocity**.

To add a user defined name to the default name, do the following:

→ Go to the **CONFIGURATION** view.

→  **SAW sensor**

→  Confirm to access the **Parameter** view.

→  **Stand. meas. values** -----> 

→  **Liquid velocity** -----> 

→  **Value name** -----> 

→    Enter the name by selecting and confirming each character. The name can have up to 19 characters.

→   **OK**

→  Save the name.

 The name is changed.

15.8.2 Activating the damping of the liquid velocity values and choosing a predefined damping level

The damping of the liquid velocity comes in addition to the damping set for the volume flow. The damping makes it possible to damp the fluctuations of the measured values of the liquid velocity:

- on the display,
- on the outputs. The damping of the liquid velocity comes in addition to the damping set for each analog output (see chapter [18.3.2](#)).

The damping is not applied to the new measured value, if the 2 following conditions are met:

- a **Low**, **Medium** or **High** damping level is active,
- and the variation between 2 values that are measured one after the other is higher than 30 % (for example when charging the pipe or stopping the flow).

By default, the liquid velocity values are not damped.

→ As an alternative to the 3 predefined damping levels **Low**, **Medium** or **High**, you can set your own damping parameters. See [15.8.3](#).

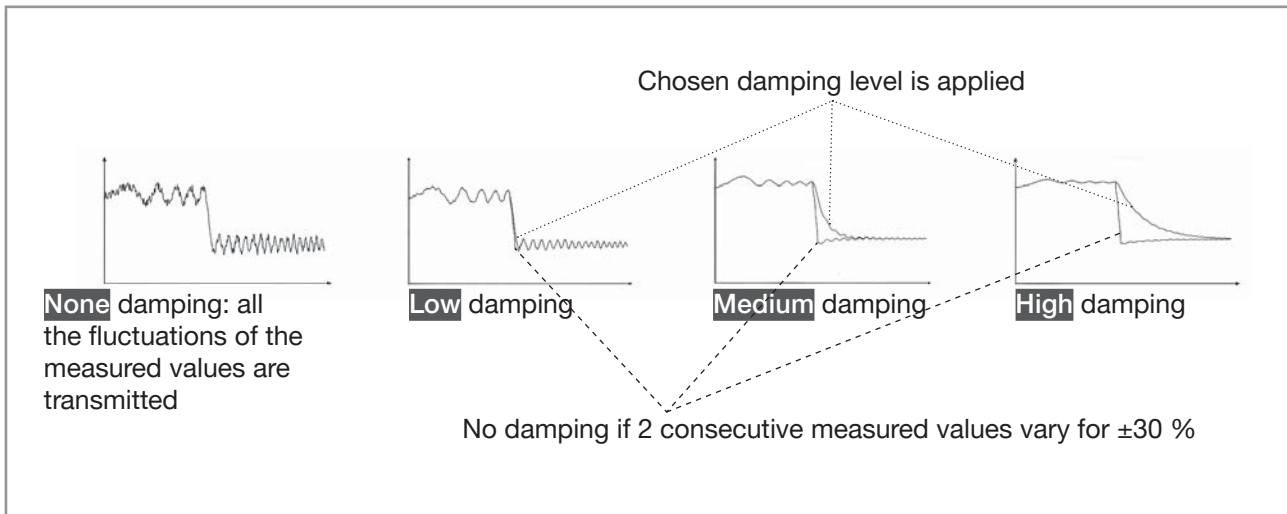

Fig. 59: Operation of the available damping levels

Table 28: Response times (10 %...90 %) of the damping levels for the liquid velocity measurements

Damping level	Response time which is associated with the damping level chosen for the volume flow plus...
None	<ul style="list-style-type: none"> • 5 s if the Refresh time is set to Long • < 0.5 s if the Refresh time is set to Short or Very short.
Low	...1 s
Medium	...10 s
High	...30 s
Special	...User-defined Response time : see chapter 15.8.3

To set a predefined damping level of the measured liquid velocity values, do the following:

→ Go to the **CONFIGURATION** view.

→ **SAW sensor**

→ Confirm to access the **Parameter** view.

→ **Stand. meas. values** ----->

→ **Liquid velocity** ----->

→ **Damping** -----> -----> The **Current settings** are displayed ----->

→ Choose a damping level between **Low**, **Medium** and **High** -----> -----> The **New settings** are displayed.

→ Save.

The damping of the liquid velocity values is active and a predefined damping level is chosen.

15.8.3 Activating a user-defined damping of the liquid velocity values

The damping makes it possible to damp the fluctuations of the measured values of the liquid velocity:

- on the display,
- on the outputs. The damping of the liquid velocity comes in addition to the damping set for each analog output (see chapter 18.3.2).

By default, the measured liquid velocity values are not damped.

To damp the fluctuations of the measured values, you can:

- either choose 1 of the 3 predefined damping levels: **Low**, **Medium** or **High**. See chapter 15.8.2.
- Or you can set your own damping parameters with the **Special** damping.

With the **Special** damping, you can set 2 parameters:

- a user-defined **Response time** in seconds,
- the **Jump threshold**, i.e. a user-defined percentage. If 2 consecutive measured values vary for \pm the percentage, no damping is applied to the second measured value.

To set your own damping parameters of the measured liquid velocity values, do the following:

→ Go to the **CONFIGURATION** view.

→  **SAW sensor**

→  Confirm to access the **Parameter** view.

→  **Stand. meas. values** -----> 



→  **Liquid velocity** -----> 

→  **Damping** ----->  -----> The **Current settings** are displayed -----> 

→  **Special** -----> 

→  Set the value of the **Response time** -----> 

→  Choose if the **Jump threshold** is enabled or disabled -----> 

→  If the **Jump threshold** is enabled, set the value. ----->  -----> The **New settings** are displayed.

→  Save.

 The special damping of the liquid velocity values is active.

15.8.4 Deactivating the damping of the liquid velocity values

By default, the liquid velocity values are not damped.

But if the damping of the liquid velocity values is active, do the following to deactivate it:

→ Go to the **CONFIGURATION** view.

→  **SAW sensor**

→  Confirm to access the **Parameter** view.

→  **Stand. meas. values** -----> 

→  **Liquid velocity** -----> 

→  **Damping** ----->  -----> The **Current settings** are displayed -----> 

→  Choose **None** ----->  -----> The **New settings** are displayed.

→  Save.

 The damping of the liquid velocity values is inactive.

15.8.5 Activating the monitoring of the liquid velocity

Because of a malfunction in the process or in the flow rate sensor, the measured liquid velocity value can be too high or too low.

A monitored value can be:

- in the normal operating range.
- in the warning range,
- in the error range.

You can set 4 limit values: 2 error limits and 2 warning limits.

→ To set the limit values, see chapter [15.8.7 Changing the error limits, the warning limits and the hysteresis of the liquid velocity](#).

Fig. 52 in [15.4.5](#) explains how the device reacts when the monitored value enters in another range (for example, from the normal range into the warning range). The reaction time depends on the hysteresis value and if the monitored value increases or decreases.

By default, the monitoring of the liquid velocity and the diagnostics are all disabled.

To activate the monitoring of the liquid velocity, do the following:







→ Go to the **CONFIGURATION** view.

→  **SAW sensor**

→  Confirm to access the **Parameter** view.

→  **Stand. meas. values** -----> 

→  **Liquid velocity** -----> 

-  Limits -----> 
-  Active -----> 
-  Yes.
-  Save.

The monitoring of the liquid velocity is active and the device status will change depending on the limits that have been set.

→ You can configure the behaviour of an analogue output depending on the status of the device. See chapter [18.3.3](#).

→ You can configure a digital output to switch every time a specific event is generated. See chapter [18.5.1 Configuring a digital output as an on/off output](#).

→ To enable the monitoring, i.e. to be informed when the value of the liquid velocity is outside the normal range, enable the diagnostics. See chapter [12.10 Activating the diagnostics function](#).

15.8.6 Deactivating the monitoring of the liquid velocity

By default, the liquid velocity values are not monitored.

But if the monitoring of the liquid velocity is active, do the following to deactivate it:

→ Go to the **CONFIGURATION** view.

→  SAW sensor

→  Confirm to access the **Parameter** view.

→  Stand. meas. values -----> 

→  Liquid velocity ----->  ----->  Limits -----> 

→  Active -----> 



























→  No.

→  Save.

The monitoring of the liquid velocity is inactive.

15.8.7 Changing the error limits, the warning limits and the hysteresis of the liquid velocity

To change the error limits, the warning limits and the hysteresis of the liquid velocity, do the following:

- Go to the **CONFIGURATION** view.
-  **SAW sensor**
-  Confirm to access the **Parameter** view.
-  **Stand. meas. values** -----  -----  **Liquid velocity** ----- 
-  **Limits** ----- 
-  **Settings** -----  ----- The **Current settings** are displayed ----- 
-   Set the high error limit ----- 
-   Set the low error limit ----- 
-   Set the high warning limit ----- 
-   Set the low warning limit ----- 
-   Set the hysteresis value -----  ----- The **New settings** are displayed.
-  Save.



 The limit values and the hysteresis value are changed.









15.8.8 Resetting the default values of the error limits, the warning limits and the hysteresis of the liquid velocity

The default values of the error limits, the warning limits and the hysteresis of the liquid velocity are the following:

- high error value: +10.0 m/s,
- low error value: -10.0 m/s,
- high warning value: +8.0 m/s,
- low warning value: -8.0 m/s,
- value of the hysteresis: 0.0 m/s.

To reset the default values of the error limits, the warning limits and the hysteresis of the liquid velocity, do the following:

- Go to the **CONFIGURATION** view.
-  **SAW sensor**
-  Confirm to access the **Parameter** view.













-  **Stand. meas. values** -----> 
-  **Liquid velocity** -----> 
-  **Limits** -----> 
-  **Reset to default** -----> 
-  Confirm.

 The limit values and the hysteresis value are reset.

-  Go back to the parent menu.

15.8.9 Resetting the default values of all the liquid velocity parameters

To reset all the default values of all the liquid velocity parameters, do the following:

- Go to the **CONFIGURATION** view.
-  **SAW sensor**
-  Confirm to access the **Parameter** view.
-  **Stand. meas. values** -----> 
-  **Liquid velocity** -----> 
-  **Reset to default** -----> 
-  Confirm.
-  All the liquid velocity parameters are reset.
-  Go back to the parent menu.
-  Confirm.

15.9 Setting the parameters of the liquid density

15.9.1 Giving a user defined name to the measured liquid density

The name is used to identify the process value in the user defined views and in all the menus where the process value is displayed (for example in the **Outputs** menu).



By default, the name associated to the measured liquid density is **Density**.

To add a user defined name to the default name, do the following:

→ Go to the **CONFIGURATION** view.



→  **SAW sensor**

→  Confirm to access the **Parameter** view.

→  **Stand. meas. values** -----> 

→  **Density** -----> 

→  **Value name** -----> 

→    Enter the name by selecting and confirming each character. The name can have up to 19 characters.

→   **OK**

→  Save the name.

 The name is changed.

15.9.2 Activating the damping of the liquid density values and choosing a predefined damping level

The damping makes it possible to damp the fluctuations of the measured values of the liquid density:

- on the display,
- on the outputs. The damping of the liquid density comes in addition to the damping set for each analog output (see chapter [18.3.2](#)),
- The damping of the liquid density comes in addition to the damping set for the mass flow rate.

The damping is not applied to the new measured value, if the 2 following conditions are met:

- a **Low**, **Medium** or **High** damping level is active,
- and the variation between 2 values that are measured one after the other is higher than 30 % (for example when charging the pipe or stopping the flow).

By default, the measured liquid density values are damped with the level **Medium**.

→ As an alternative to the 3 predefined damping levels **Low**, **Medium** or **High**, you can set your own damping parameters. See [15.9.3](#).

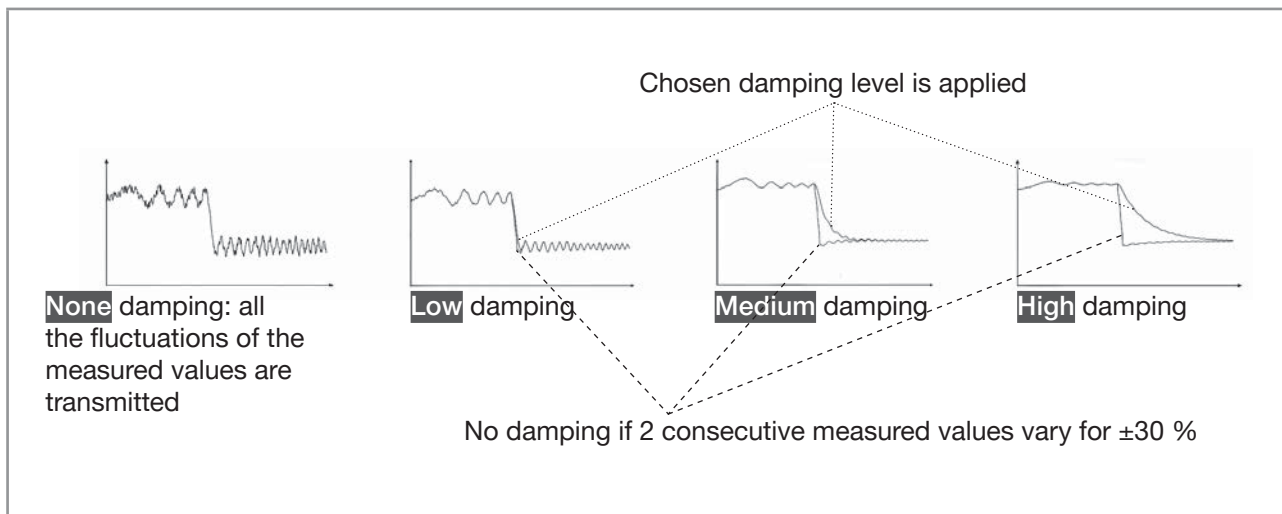

Fig. 60: Operation of the available damping levels

Table 29: Response times (10 %...90 %) of the damping levels for the liquid density measurements

Damping level	Response time which is associated with the damping level chosen for the liquid density
None	<ul style="list-style-type: none"> • 0.5 s if the Refresh time is set to Long • 1 s if the Refresh time is set to Short or Very short.
Low	3 s
Medium	10 s
High	30 s
Special	User-defined Response time

To set a predefined damping level of the measured liquid density values, do the following:

→ Go to the **CONFIGURATION** view.

→ **SAW sensor**

→ Confirm to access the **Parameter** view.

→ **Stand. meas. values**

→ **Density**

→ **Damping** → The **Current settings** are displayed

→ Choose a damping level between **Low**, **Medium** and **High** → The **New settings** are displayed.

→ Save.

The damping of the liquid density values is active and a predefined damping level is chosen.

15.9.3 Activating a user-defined damping of the liquid density values

The damping makes it possible to damp the fluctuations of the measured values of the liquid density:

- on the display,
- on the outputs. The damping of the liquid density comes in addition to the damping set for each analog output (see chapter 18.3.2).
- The damping of the liquid density comes in addition to the damping set for the mass flow rate.

To damp the fluctuations of the measured values, you can:

- either choose 1 of the 3 predefined damping levels: **Low**, **Medium** or **High**. See chapter 15.9.2. By default, the measured liquid density values are damped with the level **Medium**.
- Or you can set your own damping parameters with the **Special** damping.

With the **Special** damping, you can set 2 parameters:



- a user-defined **Response time** in seconds,
- the **Jump threshold**, i.e. a user-defined percentage. If 2 consecutive measured values vary for \pm the percentage, no damping is applied to the second measured value.

To set your own damping parameters of the measured liquid density values, do the following:

→ Go to the **CONFIGURATION** view.

→  **SAW sensor**

→  Confirm to access the **Parameter** view.

→  **Stand. meas. values** -----> 

→  **Density** -----> 

→  **Damping** ----->  -----> The **Current settings** are displayed -----> 

→  **Special** -----> 

→  Set the value of the **Response time** -----> 

→  Choose if the **Jump threshold** is enabled or disabled -----> 

→  If the **Jump threshold** is enabled, set the value. ----->  -----> The **New settings** are displayed.

→  Save.

 The special damping of the liquid density values is active.

15.9.4 Deactivating the damping of the liquid density values

By default, the measured liquid density values are damped with the level **Medium**.

To deactivate the damping of the liquid density values, do the following:

→ Go to the **CONFIGURATION** view.

→  **SAW sensor**

→  Confirm to access the **Parameter** view.

→  **Stand. meas. values** -----> 

→  **Density** -----> 

→  **Damping** ----->  -----> The **Current settings** are displayed -----> 

→  Choose **None** ----->  -----> The **New settings** are displayed.

→  Save.

 The damping of the liquid density values is inactive.

15.9.5 Activating the monitoring of the liquid density

Because of a malfunction in the process or in the flow rate sensor, the measured liquid density value can be too high or too low.

A monitored value can be:

- in the normal operating range.
- in the warning range,
- in the error range.

You can set 4 limit values: 2 error limits and 2 warning limits.

→ To set the limit values, see chapter [15.9.7 Changing the error limits, the warning limits and the hysteresis of the liquid density](#).

[Fig. 52](#) in [15.4.5](#) explains how the device reacts when the monitored value enters in another range (for example, from the normal range into the warning range). The reaction time depends on the hysteresis value and if the monitored value increases or decreases.

By default, the monitoring of the liquid density and the diagnostics are all disabled.

To activate the monitoring of the liquid density, do the following:

→ Go to the **CONFIGURATION** view.

→  **SAW sensor**

→  Confirm to access the **Parameter** view.

→  **Stand. meas. values** -----> 

→  **Density** -----> 

- Limits ----->
- Active ----->
- Yes.
- Save.

The monitoring of the liquid density is active and the device status will change depending on the limits that have been set.

→ You can configure the behaviour of an analogue output depending on the status of the device. See chapter [18.3.3](#).

→ You can configure a digital output to switch every time a specific event is generated. See chapter [18.5.1 Configuring a digital output as an on/off output](#).

→ To enable the monitoring, i.e. to be informed when the value of the liquid density is outside the normal range, enable the diagnostics. See chapter [12.10 Activating the diagnostics function](#).

15.9.6 Deactivating the monitoring of the liquid density

By default, the liquid density values are not monitored.

But if the monitoring of the liquid density is active, do the following to deactivate it:

→ Go to the **CONFIGURATION** view.

→ SAW sensor

→ Confirm to access the **Parameter** view.

→ Stand. meas. values ----->

→ Density -----> -----> Limits ----->

→ Active ----->

→ No.

→ Save.

The monitoring of the liquid density is inactive.

15.9.7 Changing the error limits, the warning limits and the hysteresis of the liquid density

To change the error limits, the warning limits and the hysteresis of the liquid density, do the following:

→ Go to the **CONFIGURATION** view.



→  **SAW sensor**

→  Confirm to access the **Parameter** view.



→  **Stand. meas. values** ----->  ----->  **Density** -----> 

→  **Limits** -----> 

→  **Settings** ----->  -----> The **Current settings** are displayed -----> 

→   Set the high error limit -----> 

→   Set the low error limit -----> 

→   Set the high warning limit -----> 

→   Set the low warning limit -----> 

→   Set the hysteresis value ----->  -----> The **New settings** are displayed.

→  Save.

 The limit values and the hysteresis value are changed.

15.9.8 Resetting the default values of the error limits, the warning limits and the hysteresis of the liquid density

The default values of the error limits, the warning limits and the hysteresis of the liquid density are the following:

- high error value: 2.0 g/cm³,
- low error value: 0.5 g/cm³,
- high warning value: 1.6 g/cm³,
- low warning value: 0.6 g/cm³,
- value of the hysteresis: 0 g/cm³.

To reset the default values of the error limits, the warning limits and the hysteresis of the liquid density, do the following:

→ Go to the **CONFIGURATION** view.

→  **SAW sensor**

→  Confirm to access the **Parameter** view.

- **Stand. meas. values** ----->
- **Density** ----->
- **Limits** ----->
- **Reset to default** ----->
- Confirm.

The limit values and the hysteresis value are reset.

- Go back to the parent menu.

15.9.9 Setting the measurement mode of liquid density

Density mode can be selected through the following values:

- Measured (value measured via SAW signals, and liquid temperature)
- Water (value calculated based on liquid temperature measured by FLOWave)
- Constant (value set to a constant value)
- Linear ($\rho = a+bT$; coefficients a and b to be set by installer, T in °C)
- Quadratic ($\rho = a+bT+cT^2$; coefficients a, b and c to be set by installer, T in °C)

When option **Density** is ordered, default density mode will be **Measured**.

- Go to the **CONFIGURATION** view.

- **SAW sensor**

- Confirm to access the **Parameter** view.

- **Stand. meas. values** ----->

- **Density** ----->











- **Mode** -----> -----> The **Current settings** are displayed. ----->

- Choose the density mode between **Measured**, **Water**, **Constant**, **Linear**, **Quadratic** ----->

- If coefficients have to be set (in **Constant**, **Linear**, **Quadratic** mode), then set the values ----->

15.9.10 Resetting the default values of all the liquid density parameters

To reset all the default values of all the liquid density parameters, do the following:

- Go to the **CONFIGURATION** view.
-  **SAW sensor**
-  Confirm to access the **Parameter** view.
-  **Stand. meas. values** -----> 
-  **Density** -----> 
-  **Reset to default** -----> 
-  Confirm.
- ✔ All the liquid density parameters are reset.
-  Go back to the parent menu.
-  Confirm.

15.10 Setting the parameters of the volume totalizers

15.10.1 Giving a user defined name to each volume totalizer

The name is used to identify the process value in the user defined views and in all the menus where the process value is displayed (for example in the **Outputs** menu).



By default, the names associated to the volume totalizers are **Totalizer 1** and **Totalizer 2**.

To add a user defined name to the default name of a volume totalizer, do the following:

→ Go to the **CONFIGURATION** view.



→  **SAW sensor**

→  Confirm to access the **Parameter** view.

→  **Stand. meas. values** -----> 

→  **Totalizer 1** or **Totalizer 2** -----> 

→  **Value name** -----> 

→    Enter the name by selecting and confirming each character. The name can have up to 19 characters.

→   **OK**

→  Save the name.

 The name is changed.

15.10.2 Choosing the counting direction of each volume totalizer

By default, the counting direction of both volume totalizers is **Positive only**.

The possible counting directions are:

- **Positive only:** the volume totalizer counts the volume of liquid that flows in the direction defined as positive, i.e. in the same direction as the arrow located on the front of the device.
- **Negative only:** the volume totalizer counts the volume of liquid that flows in the direction defined as negative, i.e. in the direction opposite to the direction of the arrow located on the front of the device.
- **Both:** the volume totalizer counts the volume of liquid that flows in the direction defined as positive but deducts the volume of liquid that flows in the direction defined as negative.

To change the counting direction of each volume totalizer, do the following:

→ Go to the **CONFIGURATION** view.

→  **SAW sensor**

→  Confirm to access the **Parameter** view.

→  **Stand. meas. values** ----->  ----->  **Totalizer 1** or **Totalizer 2** -----> 

→  **Counting direction** -----> 

→  Choose a counting direction.

→  Save.

 The counting direction is changed.

15.10.3 Activating the monitoring of each volume totalizer value

A monitored value can be:

- in the normal operating range.
- in the warning range,
- in the error range.

You can set 4 limit values: 2 error limits and 2 warning limits.

→ To set the limit values, see chapter [15.10.5 Changing the error limits, the warning limits and the hysteresis of each volume totalizer](#).

Fig. 52 in [15.4.5](#) explains how the device reacts when the monitored value enters in another range (for example, from the normal range into the warning range). The reaction time depends on the hysteresis value and if the monitored value increases or decreases.

By default, the monitoring of the volume totalizers and the diagnostics are all disabled.

To activate the monitoring of each volume totalizer, do the following:

→ Go to the **CONFIGURATION** view.

→  **SAW sensor**

→  Confirm to access the **Parameter** view.

→  **Stand. meas. values** ----->  ----->  **Totalizer 1** or **Totalizer 2** -----> 

→  **Limits** -----> 

→  **Active** -----> 

→  **Yes**

→  Save.

 The monitoring of the volume totalizer is active and the device status will change depending on the limits that have been set.

→ You can configure the behaviour of an analogue output depending on the status of the device. See chapter [18.3.3](#).

→ You can configure a digital output to switch every time a specific event is generated. See chapter [18.5.1 Configuring a digital output as an on/off output](#).

→ To enable the monitoring, i.e. to be informed when the value of a volume totalizer is outside the normal range, enable the diagnostics. See chapter [12.10 Activating the diagnostics function](#).

15.10.4 Deactivating the monitoring of each volume totalizer

By default, the volume totalizers are not monitored.

But if the monitoring of a volume totalizer is active, do the following to deactivate it:

→ Go to the **CONFIGURATION** view.

→ **SAW sensor**

→ Confirm to access the **Parameter** view.

→ **Stand. meas. values** ----- ----- **Totalizer 1** or **Totalizer 2** -----

→ **Limits** -----

→ **Active** -----

→ **No.**

→ **Save.**

The monitoring of the volume totalizer is inactive.

15.10.5 Changing the error limits, the warning limits and the hysteresis of each volume totalizer

To change the error limits, the warning limits and the hysteresis of each volume totalizer, do the following:

→ Go to the **CONFIGURATION** view.

→ **SAW sensor**

→ Confirm to access the **Parameter** view.

→ **Stand. meas. values** ----- ----- **Totalizer 1** or **Totalizer 2** -----

→ **Limits** -----

→ **Settings** ----- ----- The **Current settings** are displayed -----

→ Set the high error limit -----

→ Set the low error limit -----

→ Set the high warning limit -----

→ Set the low warning limit -----

→ Set the hysteresis value ----- ----- The **New settings** are displayed.

→ **Save.**

The limit values and the hysteresis value are changed.

15.10.6 Resetting the default values of the error limits, the warning limits and the hysteresis of each volume totalizer

The default values of the error limits, the warning limits and the hysteresis of the volume totalizers are the following:

- high error value: 10,000,000 m³,
- low error value: -10,000,000 m³,
- high warning value: 8,000,000 m³,
- low warning value: -8,000,000 m³,
- value of the hysteresis: 0.0 m³.

To reset the default values of the error limits, the warning limits and the hysteresis of each volume totalizer, do the following:

- Go to the **CONFIGURATION** view.
- **SAW sensor**
- Confirm to access the **Parameter** view.
- **Stand. meas. values** ----- ----- **Totalizer 1** or **Totalizer 2** -----
- **Limits** -----
- **Reset to default** -----
- Confirm.
- ✔ The limit values and the hysteresis value are reset.
- Go back to the parent menu.

15.10.7 Enabling the user to start, stop or reset each volume totalizer

By default, the user is not allowed to start, to stop or to reset a volume totalizer.

To authorize the user to start, to stop or to reset a volume totalizer, do the following:

- Go to the **CONFIGURATION** view.
- **SAW sensor**
- Confirm to access the **Parameter** view.
- **Stand. meas. values** ----- ----- **Totalizer 1** or **Totalizer 2** -----
- **Start/Stop/Reset** -----
- **Enabled**
- Save.
- ✔ The user is authorized to start, to stop or to reset a volume totalizer.

15.10.8 Disabling the user to start, stop or reset each volume totalizer





By default, the user is not allowed to start, to stop or to reset a volume totalizer.

If the Start/Stop/Reset of a volume totalizer is active, do the following to disable them:

→ Go to the **CONFIGURATION** view.

→  SAW sensor

→  Confirm to access the **Parameter** view.

→  Stand. meas. values   Totalizer 1 or Totalizer 2 

→  Start/Stop/Reset 

→  Disabled

→  Save.

 The user is not authorized to start or to stop or to reset a volume totalizer.





15.10.9 Starting each volume totalizer

If the Start/Stop/Reset of a volume totalizer is active, do the following to start the volume totalizer:

→ Go to the **CONFIGURATION** view.

→  SAW sensor

→  Confirm to access the **Parameter** view.

→  Stand. meas. values   Totalizer 1 or Totalizer 2 

→  Start/Stop 

→  Started

→  Save.

 The volume totalizer starts to count.





15.10.10 Stopping each volume totalizer

If the Start/Stop/Reset of a volume totalizer is active, do the following to stop the volume totalizer:

→ Go to the **CONFIGURATION** view.

→  SAW sensor

→  Confirm to access the **Parameter** view.

→  Stand. meas. values   Totalizer 1 or Totalizer 2 

→  Start/Stop 

→  Stopped

→  Save.

 The volume totalizer stops counting.

15.10.11 Resetting each volume totalizer to a **Preset value**

If the Start/Stop/Reset of a volume totalizer is active, do the following to reset the volume totalizer to the **Preset value**:

→ Go to the **CONFIGURATION** view.

→  **SAW sensor**

→  Confirm to access the **Parameter** view.

→  **Stand. meas. values** ----->  ----->  **Totalizer 1** or **Totalizer 2** -----> 

→  **Value reset** -----> 

→  Confirm.

 The volume totalizer is reset to the preset value.

→ To change the preset value of a volume totalizer, see chapter [15.10.12 Changing the Preset value for a volume totalizer reset](#).

15.10.12 Changing the **Preset value** for a volume totalizer reset

The default value of the **Preset value** is 0.0 l.

If the Start/Stop/Reset of a volume totalizer is active, do the following to change the preset value:

→ Go to the **CONFIGURATION** view.

→  **SAW sensor**

→  Confirm to access the **Parameter** view.

→  **Stand. meas. values** -----> 

→  **Totalizer 1** or **Totalizer 2** -----> 

→  **Preset value** -----> 

→   Set the value.









→  Save.

 The value is changed.

15.10.13 Resetting the overflow counter of each volume totalizer

If a volume totalizer reaches its maximum value, the associated overflow counter value is incremented by 1.









To reset the overflow counter associated to each volume totalizer, do the following:

- Go to the **CONFIGURATION** view.
-  **SAW sensor**
-  Confirm to access the **Parameter** view.
-  **Stand. meas. values** -----> 
-  **Totalizer 1** or **Totalizer 2** -----> 
-  **Reset overflow counter** -----> 
-  Confirm.

 The overflow counter associated to the volume totalizer is reset.

15.10.14 Resetting all the parameters of each volume totalizer to their default values

To reset all the parameters of each volume totalizer to their default values, do the following:

- Go to the **CONFIGURATION** view.
-  **SAW sensor**
-  Confirm to access the **Parameter** view.
-  **Stand. meas. values** -----> 
-  **Totalizer 1** or **Totalizer 2** -----> 
-  **Reset to default** ----->  ----->  Confirm.

 All the parameters of each volume totalizer are reset to their default values.

-  Go back to the parent menu.















15.11 Setting the parameters of the mass totalizers

15.11.1 Giving a user defined name to each mass totalizer

The name is used to identify the process value in the user defined views and in all the menus where the process value is displayed (for example in the **Outputs** menu).

By default, the names associated to the mass totalizers are **Mass totalizer 1** and **Mass totalizer 2**.

To add a user defined name to the default name of a mass totalizer, do the following:

- Go to the **CONFIGURATION** view.
-  **SAW sensor**
-  Confirm to access the **Parameter** view.
-  **Stand. meas. values** -----> 
-  **Mass totalizer 1** or **Mass totalizer 2** -----> 
-  **Value name** -----> 
-    Enter the name by selecting and confirming each character. The name can have up to 19 characters.
-   **OK**
-  Save the name.
- ✔ The name is changed.











15.11.2 Choosing the counting direction of each mass totalizer

By default, the counting direction of both mass totalizers is **Positive only**.

The possible counting directions are:

- **Positive only**: the mass totalizer counts the mass of liquid that flows in the direction defined as positive, i.e. in the same direction as the arrow located on the front of the device.
- **Negative only**: the mass totalizer counts the mass of liquid that flows in the direction defined as negative, i.e. in the direction opposite to the direction of the arrow located on the front of the device.
- **Both**: the mass totalizer counts the mass of liquid that flows in the direction defined as positive but deducts the mass of liquid that flows in the direction defined as negative.

To change the counting direction of each mass totalizer, do the following:

- Go to the **CONFIGURATION** view.
-  **SAW sensor**
-  Confirm to access the **Parameter** view.
-  **Stand. meas. values** -----> 
-  **Mass totalizer 1** or **Mass totalizer 2** -----> 
-  **Counting direction** -----> 
-  Choose a counting direction.
-  Save.
- ✔ The counting direction is changed.

15.11.3 Activating the monitoring of each mass totalizer value

A monitored value can be:

- in the normal operating range.
- in the warning range,
- in the error range.

You can set 4 limit values: 2 error limits and 2 warning limits.

→ To set the limit values, see chapter [15.11.5 Changing the error limits, the warning limits and the hysteresis of each mass totalizer](#).

Fig. 52 in [15.4.5](#) explains how the device reacts when the monitored value enters in another range (for example, from the normal range into the warning range). The reaction time depends on the hysteresis value and if the monitored value increases or decreases.

By default, the monitoring of the mass totalizers and the diagnostics are all disabled.

To activate the monitoring of each mass totalizer, do the following:

→ Go to the **CONFIGURATION** view.

→  **SAW sensor**

→  Confirm to access the **Parameter** view.

→  **Stand. meas. values** -----> 

→  **Mass totalizer 1** or **Mass totalizer 2** -----> 

→  **Limits** -----> 

→  **Active** -----> 

→  **Yes**

→  **Save**.

 The monitoring of the mass totalizer is active and the device status will change depending on the limits that have been set.

→ You can configure the behaviour of an analogue output depending on the status of the device. See chapter [18.3.3](#).

→ You can configure a digital output to switch every time a specific event is generated. See chapter [18.5.1 Configuring a digital output as an on/off output](#).

→ To enable the monitoring, i.e. to be informed when the value of a mass totalizer is outside the normal range, enable the diagnostics. See chapter [12.10 Activating the diagnostics function](#).

15.11.4 Deactivating the monitoring of each mass totalizer

By default, the mass totalizers are not monitored.

But if the monitoring of a mass totalizer is active, do the following to deactivate it:

- Go to the **CONFIGURATION** view.
- **SAW sensor**
- Confirm to access the **Parameter** view.
- **Stand. meas. values** ----->
- **Mass totalizer 1** or **Mass totalizer 2** ----->
- **Limits** ----->
- **Active** ----->
- **No.**
- **Save.**

The monitoring of the mass totalizer is inactive.

15.11.5 Changing the error limits, the warning limits and the hysteresis of each mass totalizer

To change the error limits, the warning limits and the hysteresis of each mass totalizer, do the following:

- Go to the **CONFIGURATION** view.
- **SAW sensor**
- Confirm to access the **Parameter** view.
- **Stand. meas. values** ----->
- **Mass totalizer 1** or **Mass totalizer 2** ----->
- **Limits** ----->
- **Settings** -----> -----> The **Current settings** are displayed ----->
- Set the high error limit ----->
- Set the low error limit ----->
- Set the high warning limit ----->
- Set the low warning limit ----->
- Set the hysteresis value -----> -----> The **New settings** are displayed.
- **Save.**

The limit values and the hysteresis value are changed.

15.11.6 Resetting the default values of the error limits, the warning limits and the hysteresis of each mass totalizer

The default values of the error limits, the warning limits and the hysteresis of the mass totalizers are the following:

- high error value: 10,000,000 t,
- low error value: -10,000,000 t,
- high warning value: 8,000,000 t,
- low warning value: -8,000,000 t,
- value of the hysteresis: 0.0 t.

To reset the default values of the error limits, the warning limits and the hysteresis of each mass totalizer, do the following:

→ Go to the **CONFIGURATION** view.

→  **SAW sensor**

→  Confirm to access the **Parameter** view.

→  **Stand. meas. values** -----  -----  **Mass totalizer 1** or **Mass totalizer 2** ----- 

→  **Limits** ----- 

→  **Reset to default** ----- 

→  Confirm.

 The limit values and the hysteresis value are reset.

→  Go back to the parent menu.

15.11.7 Enabling the user to start, stop or reset each mass totalizer

By default, the user is not allowed to start, to stop or to reset a mass totalizer.

To authorize the user to start, to stop or to reset a mass totalizer, do the following:

→ Go to the **CONFIGURATION** view.

→  **SAW sensor**

→  Confirm to access the **Parameter** view.

→  **Stand. meas. values** -----  -----  **Mass totalizer 1** or **Mass totalizer 2** ----- 

→  **Start/Stop/Reset** ----- 

→  **Enabled**

→  Save.

 The user is authorized to start, to stop or to reset a mass totalizer.

15.11.8 Disabling the user to start, stop or reset each mass totalizer

By default, the user is not allowed to start, to stop or to reset a mass totalizer.

If the Start/Stop/Reset of a mass totalizer is active, do the following to disable them:

→ Go to the **CONFIGURATION** view.

→  **SAW sensor**

→  Confirm to access the **Parameter** view.

→  **Stand. meas. values** -----> 

→  **Mass totalizer 1** or **Mass totalizer 2** -----> 

→  **Start/Stop/Reset** -----> 

→  **Disabled**

→  Save.

 The user is not authorized to start or to stop or to reset a mass totalizer.

15.11.9 Starting each mass totalizer

If the Start/Stop/Reset of a mass totalizer is active, do the following to start the mass totalizer:

→ Go to the **CONFIGURATION** view.

→  **SAW sensor**

→  Confirm to access the **Parameter** view.

→  **Stand. meas. values** -----> 

→  **Mass totalizer 1** or **Mass totalizer 2** -----> 

→  **Start/Stop** -----> 

→  **Started**

→  Save.

 The mass totalizer starts to count.

15.11.10 Stopping each mass totalizer

If the Start/Stop/Reset of a mass totalizer is active, do the following to stop the mass totalizer:

→ Go to the **CONFIGURATION** view.

→  **SAW sensor**

→  Confirm to access the **Parameter** view.

- Stand. meas. values -----> -----> Mass totalizer 1 or Mass totalizer 2 ----->
- Start/Stop ----->
- Stopped
- Save.

The mass totalizer stops counting.

15.11.11 Resetting each mass totalizer to a Preset value

If the Start/Stop/Reset of a mass totalizer is active, do the following to reset the mass totalizer to the **Preset value**:

- Go to the **CONFIGURATION** view.
- SAW sensor
- Confirm to access the **Parameter** view.
- Stand. meas. values ----->
- Mass totalizer 1 or Mass totalizer 2 ----->
- Value reset ----->
- Confirm.

The mass totalizer is reset to the preset value.

→ To change the preset value of a mass totalizer, see chapter [15.11.12 Changing the Preset value for a mass totalizer reset](#).

15.11.12 Changing the Preset value for a mass totalizer reset

The default value of the **Preset value** is 0.0 l.

If the Start/Stop/Reset of a mass totalizer is active, do the following to change the preset value:

- Go to the **CONFIGURATION** view.
- SAW sensor
- Confirm to access the **Parameter** view.
- Stand. meas. values ----->
- Mass totalizer 1 or Mass totalizer 2 ----->
- Preset value ----->
- Set the value.
- Save.

The value is changed.

15.11.13 Resetting the overflow counter of each mass totalizer

If a mass totalizer reaches its maximum value, the associated overflow counter value is incremented by 1.

To reset the overflow counter associated to each mass totalizer, do the following:

→ Go to the **CONFIGURATION** view.

→  **SAW sensor**

→  Confirm to access the **Parameter** view.

→  **Stand. meas. values** -----> 

→  **Mass totalizer 1** or **Mass totalizer 2** -----> 

→  **Reset overflow counter** -----> 

→  Confirm.

 The overflow counter associated to the mass totalizer is reset.

15.11.14 Resetting all the parameters of each mass totalizer to their default values

To reset all the parameters of each mass totalizer to their default values, do the following:

→ Go to the **CONFIGURATION** view.

→  **SAW sensor**

→  Confirm to access the **Parameter** view.

→  **Stand. meas. values** -----> 

→  **Mass totalizer 1** or **Mass totalizer 2** -----> 

→  **Reset to default** ----->  ----->  Confirm.

 All the parameters of each mass totalizer are reset to their default values.

→  Go back to the parent menu.

15.12 Setting the parameters of the differentiation factor (optional feature)

15.12.1 What is the differentiation factor?

The differentiation factor (DF) is a dimensionless measurement value which can be used to identify the liquid flowing through the pipe.

Before SW version 05.00.00, differentiation factor was named density factor. Given the fact that the option density appeared, the name was changed in order to avoid unnecessary confusion.

The DF is a non-calibrated acoustic measurement based on the measurement of the speed of sound in the liquid and can be compensated by temperature. The DF gives an idea of the density of most of aqueous liquids. By default, the temperature compensation is related to water.

→ To set a temperature compensation, refer to chapter [15.12.10](#).

Air bubbles in the liquid have an unwanted effect on the DF accuracy.

The device measures DFs in the range of 0.8...1.3.

- If a liquid flowing through the pipe has a higher density than water, the measured DF is higher than 1.
- If a liquid flowing through the pipe has a lower density than water, the measured DF is lower than 1.

Examples of DF ranges:

- The DF of water is in the range of 0.95...1.05.
- The DF of tomato ketchup is in the range of 1.1...1.3.

15.12.2 Giving a user defined name to the measured differentiation factor

The name is used to identify the process value in the user defined views and in all the menus where the process value is displayed (for example in the **Outputs** menu).

By default, the name associated to the measured DF is **DF**.

To add a user defined name to the default name, do the following:

→ Go to the **CONFIGURATION** view.

→  **SAW sensor**

→  Confirm to access the **Parameter** view.

→  **Add. meas. values** -----> 

→  **DF** -----> 

→  **Value name** -----> 

→    Enter the name by selecting and confirming each character. The name can have up to 19 characters.

→   **OK**

→  Save the name.

 The name is changed.

15.12.3 Activating the damping of the differentiation factor values and choosing a predefined damping level

The damping makes it possible to damp the fluctuations of the measured values of the DF:

- on the display,
- on the totalizers,
- on the outputs. The damping set for an analog output comes in addition to the damping of the DF.

The damping is not applied to the new measured value, if the 2 following conditions are met:

- a **Low**, **Medium** or **High** damping level is active,
- and the variation between 2 values that are measured one after the other is higher than 30 % (for example when changing the liquid in the pipe).

By default, the DF values are damped with the level **None**.

The **Low** damping level or no damping at all (**None**) are suited for applications/processes that need fast response times.

The **Medium** damping level or the **High** damping level are suited if the DF values change slowly.

→ As an alternative to the 3 predefined damping levels **Low**, **Medium** or **High**, you can set your own damping parameters. See chapter 15.12.4.

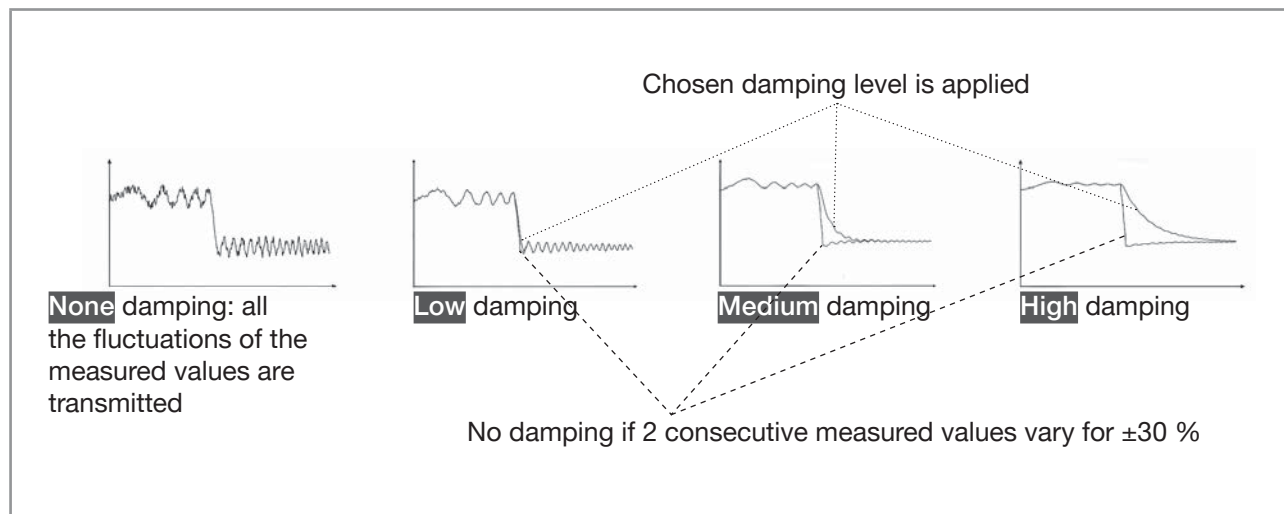

Fig. 61: Operation of the available damping levels

Table 30: Response times (10 %...90 %) of the damping levels for the DF measurements

Damping level	Response time
None	0 s
Low	1 s
Medium	10 s
High	30 s
Special	User-defined Response time : see chapter 15.12.4

To set a predefined damping level of the DF, do the following:

→ Go to the **CONFIGURATION** view.

→  **SAW sensor**

→  Confirm to access the **Parameter** view.

→  **Add. meas. values** -----> 

→  **DF** -----> 

→  **Damping** ----->  -----> The **Current settings** are displayed -----> 

→  Choose a damping level between **Low**, **Medium** and **High** ----->  -----> The **New settings** are displayed.

→  Save.

 The damping of the DF values is active and a predefined damping level is chosen.

15.12.4 Activating a user-defined damping of the differentiation factor values

The damping makes it possible to damp the fluctuations of the measured values of the DF:

- on the display,
- on the totalizers,
- on the outputs. The damping set for an analog output comes in addition to the damping of the DF.

By default, the measured DF values are damped with the level **None**.

To damp the fluctuations of the measured values, you can:

→ either choose 1 of the 3 predefined damping levels: **Low**, **Medium** or **High**. See chapter 15.12.3.

→ Or you can set your own damping parameters with the **Special** damping.

With the **Special** damping, you can set 2 parameters:

- a user-defined **Response time** in seconds,
- the **Jump threshold**, i.e. a user-defined percentage. If 2 consecutive measured values vary for ± the percentage, no damping is applied to the second measured value.

To set your own damping parameters of the DF values, do the following:

→ Go to the **CONFIGURATION** view.

→  **SAW sensor**

→  Confirm to access the **Parameter** view.

→  **Add. meas. values** -----> 

- **DF** ----->
 - **Damping** -----> -----> The **Current settings** are displayed ----->
 - **Special** ----->
 - Set the value of the **Response time** ----->
 - Choose if the **Jump threshold** is enabled or disabled ----->
 - If the **Jump threshold** is enabled, set the value.
 - -----> The **New settings** are displayed -----> Save.
- The special damping of the DF values is active.

15.12.5 Deactivating the damping of the differentiation factor values

If the damping of the DF values is active, do the following to deactivate it:

- Go to the **CONFIGURATION** view.
 - **SAW sensor**
 - Confirm to access the **Parameter** view.
 - **Add. meas. values** ----->
 - **DF** ----->
 - **Damping** -----> -----> The **Current settings** are displayed ----->
 - Choose **None** -----> -----> The **New settings** are displayed.
 - Save.
- The damping of the DF values is inactive.

15.12.6 Activating the monitoring of the differentiation factor

→ Before activating the monitoring of the DF, set the DF error and warning limits. See chapter [15.12.8](#).

By default, the monitoring of the DF and the diagnostics are all disabled.

To activate the monitoring of the DF, do the following:

→ Go to the **CONFIGURATION** view.

→  **SAW sensor**

→  Confirm to access the **Parameter** view.

→  **Add. meas. values** -----> 

→  **DF** -----> 

→  **Limits** -----> 

→  **Active** ----->  ----->  **Yes**.

→  **Save**.

 The monitoring of the DF is active and the device status will change depending on the limits that have been set.

→ You can transmit the DF value with an analogue output to a PLC for example to identify the liquid flowing through the pipe.

→ You can configure the behaviour of an analogue output depending on the status of the device. See chapter [18.3.3](#).

→ You can configure a digital output to switch every time a specific event is generated. See chapter [18.5.1 Configuring a digital output as an on/off output](#).

→ To enable the monitoring, i.e. to be informed when the value of the DF is outside the normal range, enable the diagnostics. See chapter [12.10 Activating the diagnostics function](#).

15.12.7 Deactivating the monitoring of the differentiation factor

By default, the DF values are not monitored. If the monitoring of the DF is active, do the following to deactivate it:

→ Go to the **CONFIGURATION** view.

→  **SAW sensor**

→  Confirm to access the **Parameter** view.

→  **Add. meas. values** -----> 

→  **DF** -----> 

→  **Limits** -----> 

→ Active ----->

→ No.

→ Save.

The monitoring of the DF is inactive.

15.12.8 Changing the error limits, the warning limits and the hysteresis of the differentiation factor

A monitored value can be:

- in the normal operating range.
- in the warning range,
- in the error range.

You can set 4 limit values: 2 error limits and 2 warning limits.

→ To set the limit values, see chapter [15.12.8 Changing the error limits, the warning limits and the hysteresis of the differentiation factor](#).

Fig. 52 in 15.4.5 explains how the device reacts when the monitored value enters in another range (for example, from the normal range into the warning range). The reaction time depends on the hysteresis value and if the monitored value increases or decreases.

By default, the monitoring of the DF and the diagnostics are all disabled.

To change the error limits, the warning limits and the hysteresis of the DF, do the following:

→ Go to the **CONFIGURATION** view.

→ SAW sensor

→ Confirm to access the **Parameter** view.

→ Add. meas. values ----->

→ DF ----->

→ Limits ----->

→ Settings -----> -----> The **Current settings** are displayed ----->

→ Set the high error limit ----->

→ Set the low error limit ----->

→ Set the high warning limit ----->

→ Set the low warning limit ----->

→ Set the hysteresis value -----> -----> The **New settings** are displayed.

→ Save.

The limit values and the hysteresis value are changed.

15.12.9 Resetting the default values of the error limits, the warning limits and the hysteresis of the differentiation factor

The default values of the error limits, the warning limits and the hysteresis of the DF are the following:

- high error value: 1.6000
- low error value: 0.5000,
- high warning value: 1.5000,
- low warning value: 0.6000
- value of the hysteresis: 0.0100.

To reset the default values of the error limits, the warning limits and the hysteresis of the DF, do the following:

→ Go to the **CONFIGURATION** view.

→  **SAW sensor**

→  Confirm to access the **Parameter** view.

→  **Add. meas. values** ----->  ----->  **DF** -----> 

→  **Limits** -----> 

→  **Reset to default** -----> 

→  Confirm.

 The limit values and the hysteresis value are reset.

→  Go back to the parent menu.

15.12.10 Setting the temperature compensation to measure the differentiation factor



All equations used in order to get liquid concentration values are using the default DF temperature compensation. When changing the DF temperature compensation, you may alter the liquid concentration measurement.

In order that the DF of the liquid stays constant whatever the liquid temperature, the DF must be temperature compensated.

→ You can only set the temperature compensation for 1 of the liquids that may flow through the pipe.

The device has 2 types of temperature compensations to measure the DF:

- according to an equation that is specific to water, i.e. when water flows through the pipe, the DF will always be equal to 1, whatever the water temperature. The equation for water cannot be changed. See chapter [15.12.12 Activating the temperature compensation for water](#).
- according to an equation of 5th order for which you can set the 5 constants. See chapter [15.12.11 Setting the temperature compensation for a liquid other than water](#).

By default, the temperature compensation is made according to an equation that is specific to water and that cannot be changed.

15.12.11 Setting the temperature compensation for a liquid other than water

You can set the 5 constants ($a_0...a_5$) of the equation which compensates the temperature of the liquid to calculate the DF:

$$a_0 + a_1T + a_2T^2 + a_3T^3 + a_4T^4 + a_5T^5$$

→ To help you define the 5 constants a_0 to a_5 , contact Bürkert.

To activate the temperature compensation for a liquid other than water, do the following:

→ Go to the **CONFIGURATION** view.

→ **SAW sensor**

→ Confirm to access the **Parameter** view.

→ **Add. meas. values** ----->

→ **DF** ----->

















→ **Compensation** -----> The current settings are displayed.

→ Confirm.

→ **Manual** -----> Confirm.













→ Set the value of the constant a_0 , in the scientific notation. For example, to set the value 0.93724, enter 93.724000E-02 or, to set the value 372.4, enter 3.724000E+02.

→ Confirm.

-   Set the value of the constant a_1 , in the scientific notation.
-  Confirm.
-   Set the value of the constant a_2 , in the scientific notation.
-  Confirm.
-   Set the value of the constant a_3 , in the scientific notation.
-  Confirm.
-   Set the value of the constant a_4 , in the scientific notation.
-  Confirm.
-   Set the value of the constant a_5 , in the scientific notation.
-  Confirm -----> The new settings are displayed.
-  Save.
- The temperature compensation for a liquid other than water is active.

15.12.12 Activating the temperature compensation for water

To activate the temperature compensation for water, do the following:

- Go to the **CONFIGURATION** view.
-  **SAW sensor**
-  Confirm to access the **Parameter** view.
-  **Add. meas. values** -----> 
-  **DF** -----> 
-  **Compensation** ----->  The current settings are displayed.
-  Confirm.
-  **Water**
-  Confirm -----> The new settings are displayed.
-  Save.
- The temperature compensation for water is active.

15.12.13 Resetting the default values of all the differentiation factor parameters

To reset all the default values of the DF parameters, do the following:

→ Go to the **CONFIGURATION** view.

→  **SAW sensor**

→  Confirm to access the **Parameter** view.

→  **Add. meas. values** ----->  ----->  **DF** -----> 

→  **Reset to default** ----->  ----->  Confirm.

 All the DF parameters are reset.

→  Go back to the parent menu.

15.12.14 Use case example of the differentiation factor

If different liquids with different DFs may flow through the pipe, you can identify the liquid flowing through the pipe at a given time.

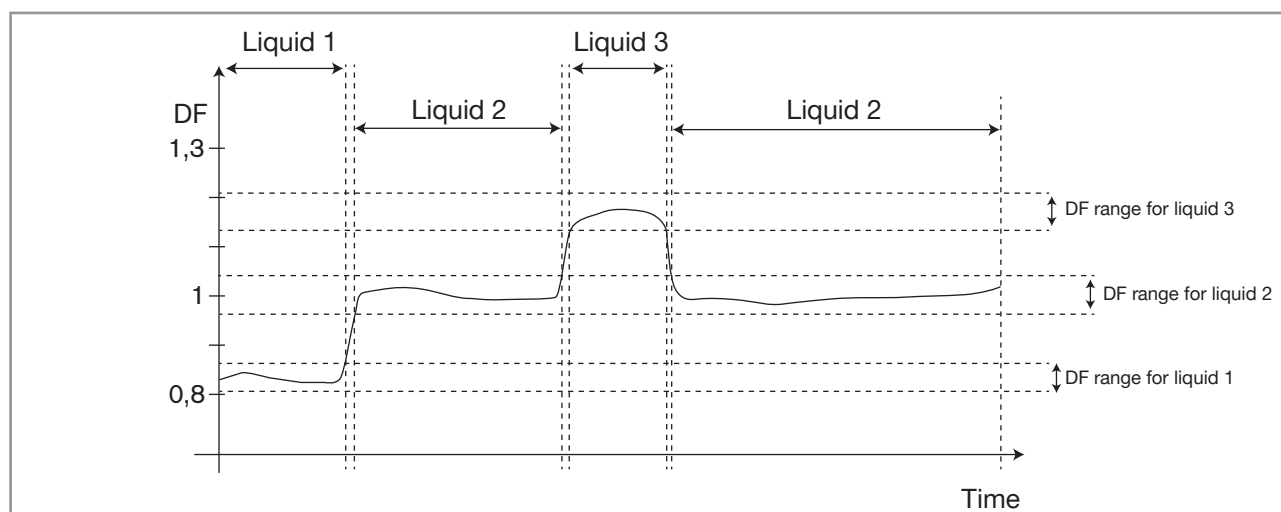

Fig. 62: Ranges of the DF for different liquids flowing through the pipe

To identify the liquid flowing through the pipe, do the following:

→ Connect an analogue output or a digital output configured as a frequency output to a PLC for example.

→ Associate the DF to the used analogue output or digital output. See chapter [18.3.1 Changing the process value and the process value range associated to an analogue output](#) or chapter [18.5.3 Configuring a digital output as a frequency output](#).

→ Make sure you exactly know the ranges of the DF values for the different liquids that may flow through the pipe.

→ If necessary, choose the type of temperature compensation for one of the liquids. See chapter [15.12.10](#).

→ Configure the ranges in the PLC so that you can clearly identify which liquid is flowing through the pipe.

15.13 Setting the parameters of the acoustic transmission factor (optional feature)

15.13.1 What is the acoustic transmission factor?

The acoustic transmission factor makes it possible to know the quality of the transmission of sound in the liquid thus the reliability of the measurements.

Indeed, the wave transit time in the liquid and the wave amplitude change depending on the following criteria:

- the type of liquid: aqueous solution, oil solution, emulsion, ...
- the presence of gas bubbles,
- the presence of solid particles,
- the liquid temperature,
- the DN of the pipe.

The acoustic transmission factor, given in %, is calculated on the base of the amplitude changes of the waves. The acoustic transmission factor of water without gas bubbles is equal to 100 % at a water temperature of +23 °C.

The temperature changes of the liquid are not compensated for the measurement of the acoustic transmission factor.

The device measures acoustic transmission factors from 10 % and up.

- If the wave amplitude in a liquid flowing through the pipe is higher than the wave amplitude in water, the measured acoustic transmission factor will be higher than 100 %.
- If the wave amplitude in a liquid flowing through the pipe is lower than the wave amplitude in water, the measured acoustic transmission factor will be lower than 100 %.

Gas bubbles or solid particles in the liquid have a similar effect on the transmission acoustic factor. If the concentration of gas bubbles or solid particles increases in a liquid, the acoustic transmission factor decreases. So, measuring and monitoring the acoustic transmission factor can be used to detect the presence of gas bubbles or solid particles in the liquid.

→ Take into account that special process conditions can have an effect on aging of the sensor thus on the acoustic transmission factor value.

15.13.2 Giving a user defined name to the measured acoustic transmission factor

The name is used to identify the process value in the user defined views and in all the menus where the process value is displayed (for example in the **Outputs** menu).

By default, the name associated to the measured acoustic transmission factor is **Acoustic transmis.**

To add a user defined name to the default name, do the following:

→ Go to the **CONFIGURATION** view.



→  **SAW sensor**

→  Confirm to access the **Parameter** view.

→  **Add. meas. values** -----> 

→  **Acoustic transmission factor** -----> 

→  **Value name** -----> 

→    Enter the name by selecting and confirming each character. The name can have up to 19 characters.

→   **OK**

→  Save the name.

 The name is changed.

15.13.3 Activating the damping of the values of the acoustic transmission factor and choosing a predefined damping level

The damping makes it possible to damp the fluctuations of the measured values of the acoustic transmission factor:

- on the display,
- on the totalizers,
- on the outputs. The damping set for an analog output comes in addition to the damping of the acoustic transmission factor.

The damping is not applied to the new measured value, if the 2 following conditions are met:

- a **Low**, **Medium** or **High** damping level is active,
- and the variation between 2 values that are measured one after the other is higher than 30 %

By default, the values of the acoustic transmission factor are damped with the level **None**.

The **Low** damping level or no damping at all (**None**) are suited for applications/processes that need fast response times.

The **Medium** damping level or the **High** damping level are suited if the values of the acoustic transmission factor change slowly.

→ As an alternative to the 3 predefined damping levels **Low**, **Medium** or **High**, you can set your own damping parameters. See chapter [15.13.4](#).

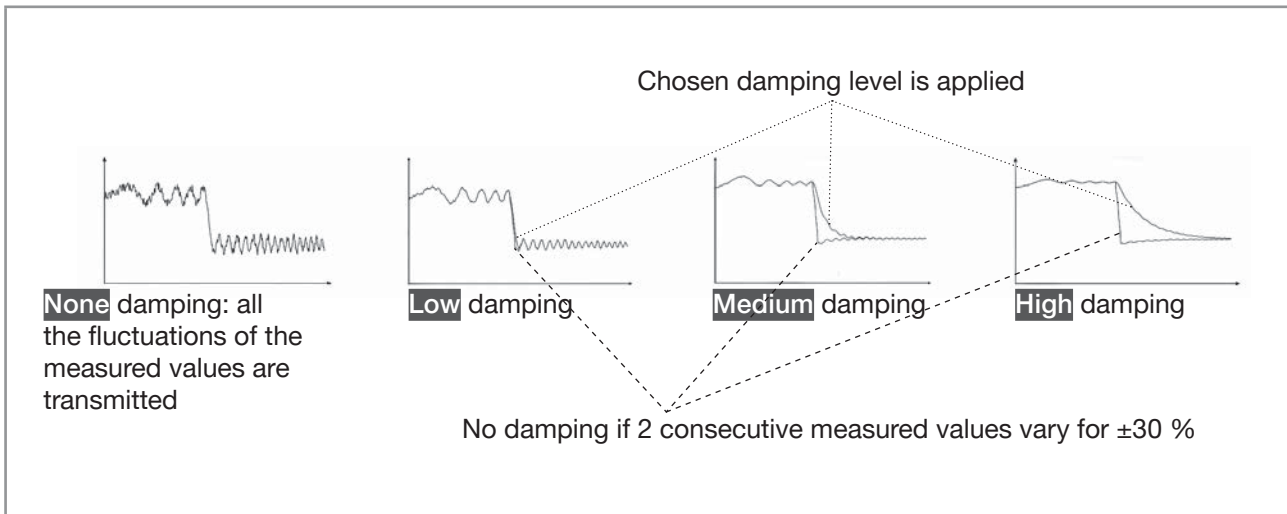

Fig. 63: Operation of the available damping levels

Table 31: Response times (10 %...90 %) of the damping levels for the measurements of the acoustic transmission factor

Damping level	Response time
None	0 s
Low	1 s
Medium	10 s
High	30 s
Special	User-defined Response time: see chapter 15.13.4

To set a predefined damping level of the acoustic transmission factor, do the following:

→ Go to the **CONFIGURATION** view.

→ **SAW sensor**

→ Confirm to access the **Parameter** view.

→ **Add. meas. values** -----

→ **Acoustic transmission factor** -----

→ **Damping** ----- ----- The **Current settings** are displayed -----

→ Choose a damping level between **Low**, **Medium** and **High** ----- ----- The **New settings** are displayed.

→ Save.

The damping of the values of the acoustic transmission factor is active and a predefined damping level is chosen.

15.13.4 Activating a user-defined damping of the values of the acoustic transmission factor

The damping makes it possible to damp the fluctuations of the measured values of the acoustic transmission factor:

- on the display,
- on the totalizers,
- on the outputs. The damping set for an analog output comes in addition to the damping of the acoustic transmission factor.

By default, the measured values of the acoustic transmission factor are damped with the level **None**.

To damp the fluctuations of the measured values, you can:

- either choose 1 of the 3 predefined damping levels: **Low**, **Medium** or **High**. See chapter 15.13.3.
- Or you can set your own damping parameters with the **Special** damping.

With the **Special** damping, you can set 2 parameters:



- a user-defined **Response time** in seconds,
- the **Jump threshold**, i.e. a user-defined percentage. If 2 consecutive measured values vary for \pm the percentage, no damping is applied to the second measured value.

To set your own damping parameters of the DF values, do the following:

→ Go to the **CONFIGURATION** view.

→  **SAW sensor**

→  Confirm to access the **Parameter** view.

→  **Add. meas. values** -----> 

→  **Acoustic transmission factor** -----> 

→  **Damping** ----->  -----> The **Current settings** are displayed -----> 

→  **Special** -----> 

→  Set the value of the **Response time** -----> 

→  Choose if the **Jump threshold** is enabled or disabled -----> 

→  If the **Jump threshold** is enabled, set the value.

→  -----> The **New settings** are displayed ----->  Save.

 The special damping of the values of the acoustic transmission factor is active.

15.13.5 Deactivating the damping of the values of the acoustic transmission

If the damping of the values of the acoustic transmission factor is active, do the following to deactivate it:

- Go to the **CONFIGURATION** view.
- **SAW sensor**
- Confirm to access the **Parameter** view.
- **Add. meas. values** ----->
- **Acoustic transmission factor** ----->
- **Damping** -----> -----> The **Current settings** are displayed ----->
- Choose **None** -----> -----> The **New settings** are displayed.
- Save.

The damping of the values of the acoustic transmission factor is inactive.

15.13.6 Changing the error limits, the warning limits and the hysteresis of the acoustic transmission factor

To change the error limits, the warning limits and the hysteresis of the acoustic transmission factor, do the following:

- Go to the **CONFIGURATION** view.
- **SAW sensor**
- Confirm to access the **Parameter** view.
- **Add. meas. values** ----->
- **Acoustic transmission factor** ----->
- **Limits** ----->
- **Settings** -----> -----> The **Current settings** are displayed ----->
- Set the high error limit ----->
- Set the low error limit ----->
- Set the high warning limit ----->
- Set the low warning limit ----->
- Set the hysteresis value -----> -----> The **New settings** are displayed.
- Save.

The limit values and the hysteresis value are changed.

15.13.7 Activating the monitoring of the acoustic transmission factor

To be informed when the concentration of gas bubbles or solid particles changes in the liquid, monitor the acoustic transmission factor.

A monitored value can be:

- in the normal operating range.
- in the warning range,
- in the error range.

You can set 4 limit values: 2 error limits and 2 warning limits.

→ To set the limit values, see chapter [15.13.6 Changing the error limits, the warning limits and the hysteresis of the acoustic transmission factor](#).

Fig. 52 in [15.4.5](#) explains how the device reacts when the monitored value enters in another range (for example, from the normal range into the warning range). The reaction time depends on the hysteresis value and if the monitored value increases or decreases.

By default, the monitoring of the acoustic transmission factor and the diagnostics are all disabled.

To activate the monitoring of the acoustic transmission factor, do the following:

→ Go to the **CONFIGURATION** view.

→  **SAW sensor**

→  Confirm to access the **Parameter** view.

→  **Add. meas. values** -----> 

→  **Acoustic transmission factor** -----> 

→  **Limits** -----> 

→  **Active** -----> 

→  **Yes.**

→  **Save.**

 The monitoring of the acoustic transmission factor is active and the device status will change depending on the limits that have been set.

→ You can configure the behaviour of an analogue output depending on the status of the device. See chapter [18.3.3](#).

→ You can configure a digital output to switch every time a specific event is generated. See chapter [18.5.1 Configuring a digital output as an on/off output](#).

→ To enable the monitoring, i.e. to be informed when the value of the acoustic transmission factor is outside the normal range, enable the diagnostics. See chapter [12.10 Activating the diagnostics function](#).

15.13.8 Deactivating the monitoring of the acoustic transmission factor

By default, the acoustic transmission factor values are not monitored.

But if the monitoring of the acoustic transmission factor is active, do the following to deactivate it:

→ Go to the **CONFIGURATION** view.

→  **SAW sensor**

→  Confirm to access the **Parameter** view.

→  **Add. meas. values** -----> 

→  **Acoustic transmission factor** -----> 

→  **Limits** -----> 

→  **Active** ----->  ----->  **No.**

→  **Save.**

 The monitoring of the acoustic transmission factor is inactive.

15.13.9 Resetting the default values of the error limits, the warning limits and the hysteresis of the acoustic transmission factor

The default values of the error limits, the warning limits and the hysteresis of the acoustic transmission factor are the following:



- high error value: 195 %,
- low error value: 5 %,
- high warning value: 190 %,
- low warning value: 10 %,
- value of the hysteresis: 1 %.

To reset the default values of the error limits, the warning limits and the hysteresis of the acoustic transmission factor, do the following:

→ Go to the **CONFIGURATION** view.



→  **SAW sensor**

→  Confirm to access the **Parameter** view.

→  **Add. meas. values** -----> 

→  **Acoustic transmission factor** -----> 

→  **Limits** -----> 











→  **Reset to default** ----->  ----->  **Confirm.**

 The limit values and the hysteresis value are reset.

→  Go back to the parent menu.

15.13.10 Resetting the default values of all the acoustic transmission factor parameters

To reset all the default values of all the acoustic transmission factor parameters, do the following:

- Go to the **CONFIGURATION** view.
-  **SAW sensor**
-  Confirm to access the **Parameter** view.
-  **Add. meas. value** -----> 
-  **Acoustic transmission factor** -----> 
-  **Reset to default** ----->  ----->  **Confirm**.
- ✔ All the acoustic transmission factor parameters are reset.
-  Go back to the parent menu.

15.14 Diagnostics: monitoring special events that occur in the process, on the sensor or on the electronics

You can be informed when a special event occurs in the process, on the sensor or on the electronics of the device. You can also choose each event to be a normal operating.

The possible events are listed in [Table 32](#) in [Table 33](#) and in [Table 34](#).

→ To be informed if a special event occurs in the process, on the sensor or on the electronics, configure the diagnostics as shown in the flowchart in [Fig. 64](#) on page 235.

You can be informed through the colour of the device status indicator and/or through a message and/or through one or several outputs as shown in the flowcharts in [Fig. 65](#) and in [Fig. 66](#).

Table 32: Diagnostics: special events in the process

Special event in the process	Meaning	Special condition
Not totally filled	The tube is not totally filled. If the parameter Refresh time is set to Very short , the event Not totally filled cannot be monitored.	Not all the sensors are in contact with the liquid.
Liquid out of range	The speed of sound in the liquid is out of range.	<ul style="list-style-type: none"> • DN08, 3/8", 1/2": The speed of sound in the liquid is lower than 1000 m/s or higher than 2000 m/s. • DN15 and above, 3/4" and above: The speed of sound in the liquid is lower than 800 m/s or higher than 2300 m/s.
Unstable flow	The flow rate is not stable.	The standard deviation of the flow rate measurements is too high.
Low flow cut off	The cut-off value of the flow rate has been used.	The cut-off function must be enabled: see chapter 15.4.9 Enabling the cut-off function of the volume flow rate .
Change of liquid	A different liquid flows in the pipe. The message is active for 10 s on the display.	The speed of sound in the liquid has changed by more than 3 m/s in 1 second.
Backward flow	The liquid flows in the opposite direction as the one set in chapter 17.4 Setting the direction of the flow .	-

Table 33: Diagnostics: special events occurring on the sensor

Special event occurring on the sensor	Meaning	Special condition
Sound cond. out of range	There are gas bubbles or solid particles in the liquid.	-

Table 34: Diagnostics: special events occurring on the electronics

Special event occurring on the electronics	Meaning	Special condition
Output 1, open loop Output 3, open loop	There is a connection problem on the related output.	The related analogue output must not be disabled. See chapter 18.4 Disabling an analogue output
Output 1, Diag. error Output 3, Diag. error	There is a connection problem on the related output or a high resistance is detected in the loop.	The related analogue output must not be disabled. See chapter 18.4 Disabling an analogue output .
Output 2 overload	An overload has been detected on the related digital output.	-
Output 3 overload	The output has switched.	

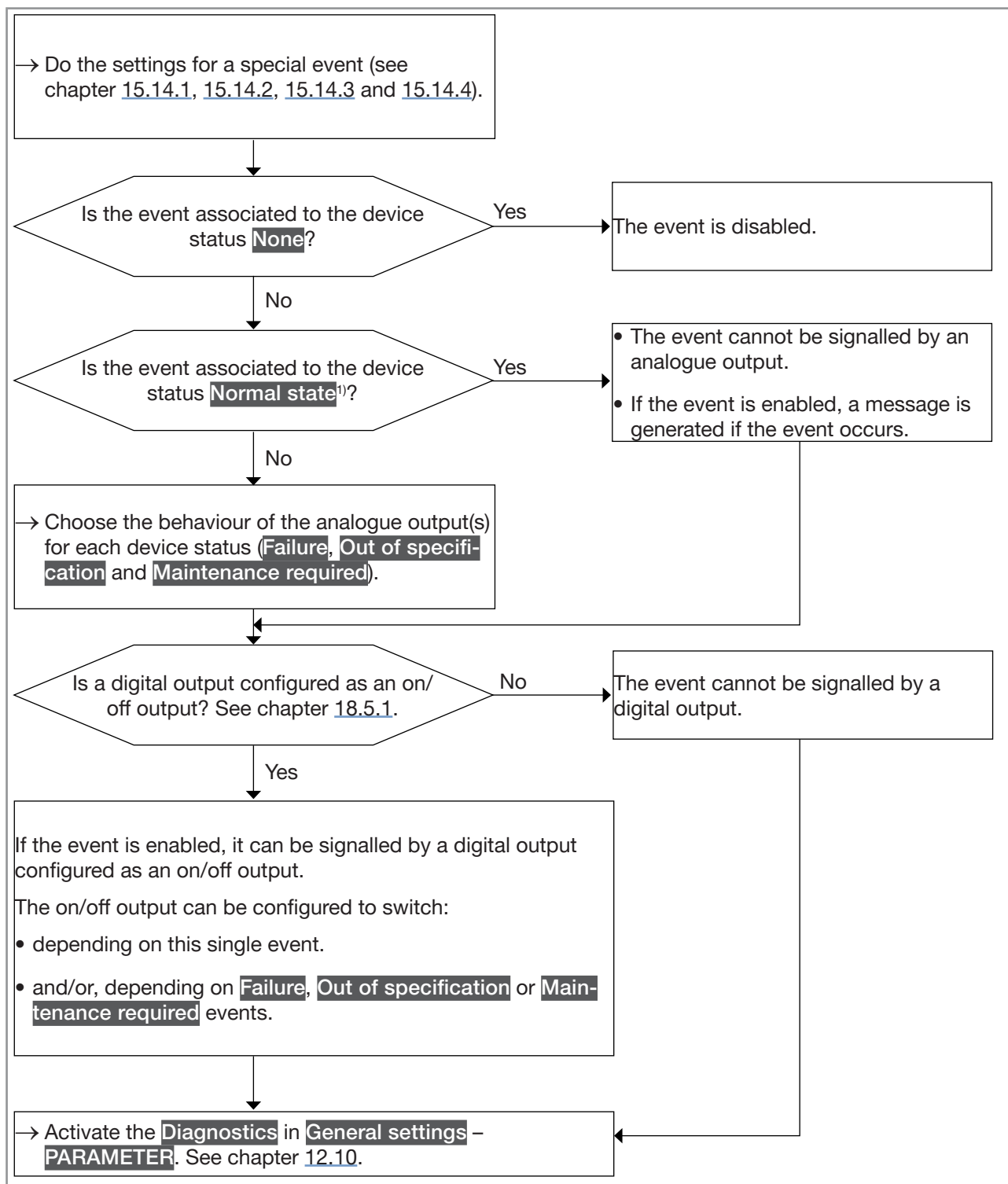
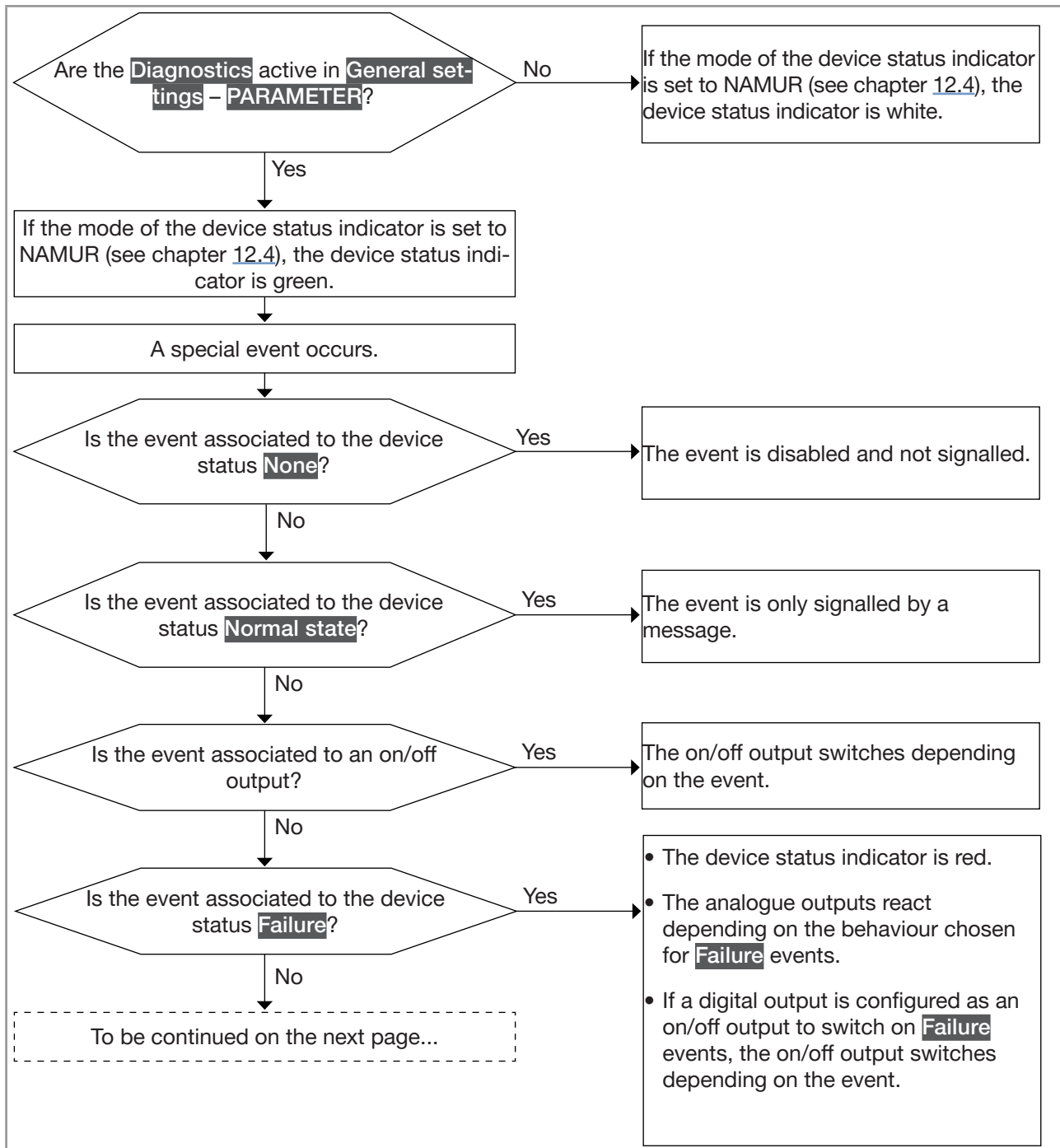

Fig. 64: Flowchart: configuration of the diagnostics

¹) **Normal state** means that only a message is generated when the event occurs but the event is considered to be part of the normal operating of the process, or of the electronics, or of the sensor.



MAN 1000273158 EN Version: M Status: RL (released | freigegeben) printed: 22.06.2022

Fig. 65: Flowchart: operating of the diagnostics when a special event occurs (part 1/2)

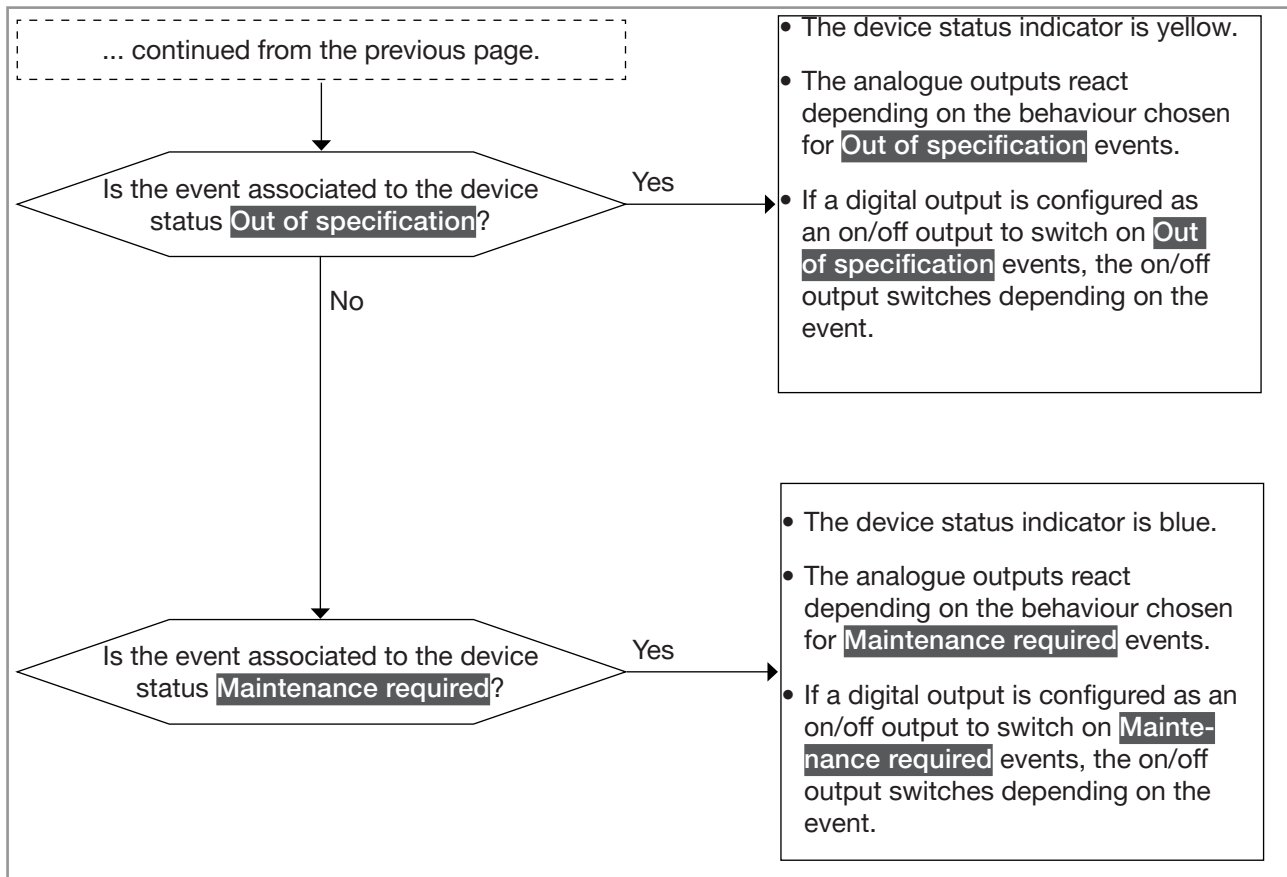

Fig. 66: Flowchart: operating of the diagnostics when a special event occurs (part 2/2)

15.14.1 Enabling the diagnostics for special events in the process

By default, all the diagnostics related to the process are disabled.

To enable the diagnostics of a special event related to the process, do the following:

→ Go to the **CONFIGURATION** view.

→ **SAW sensor**

→ Confirm to access the **Parameter** view.

→ **Diag events** -----

→ **Process** -----

→ Choose the special event ----- ----- Choose whether the information related to the special event is a **Failure**, an **Out of specification**, a **Maintenance required** or a **Normal state** -----

→ Save.

The diagnostics on the special event is enabled.

→ To be informed that an event occurs, activate all the diagnostics on the device. See chapter [12.10](#).

15.14.2 Disabling the diagnostics on a special event related to the process

By default, all the diagnostics related to the process are disabled.

If a special event related to the process is enabled, do the following to disable the event:

- Go to the **CONFIGURATION** view.
 - **SAW sensor**
 - Confirm to access the **Parameter** view.
 - **Diag events** ----->
 - **Process** ----->
 - Choose the special event ----->
 - Choose **None** ----->
 - Save.
- The diagnostics on the special event is disabled.

15.14.3 Disabling the diagnostics on a special event occurring on the electronics

By default, all the diagnostics related to special events occurring on the electronics are disabled.

If a special event occurring on the electronics is enabled, do the following to disable the event:

- Go to the **CONFIGURATION** view.
 - **SAW sensor**
 - Confirm to access the **Parameter** view.
 - **Diag events** ----->
 - **Electronic** ----->
 - Choose the special event ----->
 - Choose **None** ----->
 - Save.
- The diagnostics on the special event is disabled.

15.14.4 Enabling the diagnostics for special events occurring on the electronics

By default, all the diagnostics related to the electronics are disabled.

To enable the diagnostics related to the electronics, do the following:



→ Go to the **CONFIGURATION** view.



→  **SAW sensor**

→  Confirm to access the **Parameter** view.

→  **Diag events** -----> 

→  **Electronic** -----> 

→  Choose the event -----> 

→  Choose whether the information related to the electronics event is a **Failure**, an **Out of specification**, a **Maintenance required** or a **Normal state** -----> 

→  Save.

 The diagnostics on the electronics event is enabled.

→ To be informed that an event occurs, activate all the diagnostics on the device. See chapter [12.10](#).

15.14.5 Disabling the diagnostics on a special event occurring on the sensor

By default, all the diagnostics related to special events occurring on the sensor are disabled.

If a special event occurring on the sensor is enabled, do the following to disable the event:

→ Go to the **CONFIGURATION** view.

→  **SAW sensor**

→  Confirm to access the **Parameter** view.

→  **Diag events** -----> 

→  **Sensor** -----> 

→  Choose the special event -----> 

→  Choose **None**

→  Save.

 The diagnostics on the special event is disabled.

15.14.6 Enabling the diagnostics for special events occurring on the sensor

By default, all the diagnostics related to the sensor are disabled.

To enable the diagnostics related to the sensor, do the following:



→ Go to the **CONFIGURATION** view.

→  **SAW sensor**

→  Confirm to access the **Parameter** view.

→  **Diag events** -----> 

→  **Sensor** -----> 

→  Choose the event -----> 

→  Choose whether the information related to the sensor event is a **Failure**, an **Out of specification**, a **Maintenance required** or a **Normal state** -----> 

→  Save.

 The diagnostics on the sensor event is enabled.

→ To be informed that an event occurs, activate all the diagnostics on the device. See chapter [12.10](#).

15.15 Getting as accurate measurements of the volume flow rate, the mass flow rate or the liquid velocity as possible

To get as accurate measurements of the volume flow rate, the mass flow rate or the liquid velocity as possible, you can activate the compensation of the kinematic viscosity (in mm²/s).

The following kinematic viscosity compensations are available:

- for water or a liquid whose viscosity ν (in mm²/s) varies with the temperature T (in °C) like the viscosity of water and in the same range as water. Default setting. The related equation is:

$$\nu = \frac{1}{0,555029 + 0,020217T + 9,9 \cdot 10^{-5}T^2}$$

→ To activate the viscosity compensation for water, see chapter [15.15.1](#).

- for a liquid with a constant viscosity. To be chosen if the liquid temperature is constant and thus the viscosity of the liquid is constant. The related equation is:

$$\nu = a$$

→ To activate the viscosity compensation for a liquid whose viscosity is constant, see chapter [15.15.2](#).

- for a liquid with a linear compensation curve. To be chosen if the viscosity of the liquid varies in a linear way depending on the liquid temperature. The related equation is:

$$\nu = a + bT$$

→ To activate the viscosity compensation for a liquid with a linear viscosity compensation curve, see chapter [15.15.3](#).

- for a liquid with a quadratic compensation curve. To be chosen if the viscosity of the liquid varies in a quadratic way depending on the liquid temperature. The related equation is:

$$\nu = a + bT + cT^2$$

→ To activate the viscosity compensation for a liquid with a quadratic viscosity compensation curve, see chapter [15.15.4](#).











- for a liquid with an inverse quadratic compensation curve. To be chosen if the viscosity of the liquid varies in an inverse quadratic way depending on the liquid temperature, but the viscosity range is different from the one of water. The related equation is:

$$\nu = \frac{1}{a + bT + cT^2}$$

→ To activate the viscosity compensation for a liquid with an inverse quadratic viscosity compensation curve, see chapter [15.15.5](#).

15.15.1 Activating the viscosity compensation for water-like liquids













To activate the viscosity compensation of water-like liquids, do the following:

- Go to the **CONFIGURATION** view.
-  **SAW sensor**
-  Confirm to access the **Parameter** view.
-  **Viscosity compensation** -----> 
-  **Settings** ----->  The current settings are displayed.
-  Confirm ----->  **Water**
-  Confirm ----->  Save.
- ✔ The viscosity compensation for a water-like liquid is active.

15.15.2 Activating the compensation for a liquid with a constant viscosity

The kinematic viscosity of a liquid can be constant either because the temperature of the liquid is constant or because the temperature changes have a very low effect on the viscosity.

To activate the compensation for a liquid with a constant viscosity, do the following:

- Go to the **CONFIGURATION** view.
-  **SAW sensor**
-  Confirm to access the **Parameter** view.
-  **Viscosity compensation** -----> 
-  **Settings** ----->  The current settings are displayed.
-  Confirm.
-  **Constant** ----->  Confirm.
-   Set the value of the liquid viscosity in the displayed units (mm²/s). You must enter a positive value. For example, to set the kinematic viscosity value for oil at 20 °C, i.e. 89 mm²/s, enter 8.900000E+01.
-  -----> The **New settings** are displayed.
-  Save.
- ✔ The compensation for a liquid with a constant viscosity is active.

15.15.3 Activating the compensation for a liquid with a linear viscosity compensation curve



To activate the compensation for a liquid with a viscosity that changes in a linear way with the liquid temperature, do the following:

→ Go to the **CONFIGURATION** view.

→  **SAW sensor**

→  Confirm to access the **Parameter** view.



→  **Viscosity compensation** -----> 

→  **Settings** ----->  The current settings are displayed.



→  Confirm.

→  **Linear**

→  Confirm.

→   Set the value of the constant a of the linear curve, in the displayed units (mm²/s), and in the scientific notation. For example, to set the value 0.03724, enter 3.724000E-02 or, to set the value 372.4, enter 3.724000E+02.

→  Confirm.

→   Set the value of the constant b of the linear curve, in the displayed units, and in the scientific notation.

→  Confirm.

→  Save.

 The compensation for a liquid with a linear compensation curve is active.

If the calculated result of the equation is negative or equal to 0 (for example if the liquid temperature is not in the range covered by the equation, or if a wrong constant value has been entered), the compensated volume flow is incorrect and the error message **Viscosity compensation failed** is displayed. If the message is displayed, do the following:

→ Make sure the liquid temperature is in the range covered by the equation.

→ Make sure you have entered correct a constant value.

15.15.4 Activating the compensation for a liquid with a quadratic viscosity compensation curve



To activate the compensation for a liquid with a quadratic viscosity compensation curve, do the following:

→ Go to the **CONFIGURATION** view.

→  **SAW sensor**

→  Confirm to access the **Parameter** view.



→  **Viscosity compensation** -----> 

→  **Settings** ----->  The current settings are displayed.



→  Confirm.

→  **Quadratic**



→  Confirm.

→   Set the value of constant *a* of the quadratic curve, in the displayed units (mm²/s), and in the scientific notation. For example, to set the value 0.03724, enter 3.724000E-02 or, to set the value 372.4, enter 3.724000E+02.

→  Confirm.

→   Set the value of constant *b* of the quadratic curve, in the displayed units, and in the scientific notation.

→  Confirm.

→   Set the value of constant *c* of the quadratic curve, in the displayed units, and in the scientific notation.

→  Confirm.

→  Save.

 The compensation for a liquid with a quadratic compensation curve is active.

If the calculated result of the equation is negative or equal to 0 (for example if the liquid temperature is not in the range covered by the equation, or if wrong constant values have been entered), the compensated volume flow is incorrect and the error message **Viscosity compensation failed** is displayed. If the message is displayed, do the following:

→ Make sure the liquid temperature is in the range covered by the equation.

→ Make sure you have entered correct constant values.

15.15.5 Activating the compensation for a liquid with an inverse quadratic viscosity compensation curve



To activate the compensation for a liquid with an inverse quadratic compensation curve, do the following:

→ Go to the **CONFIGURATION** view.

→  **SAW sensor**

→  Confirm to access the **Parameter** view.



→  **Viscosity compensation** -----> 

→  **Settings** ----->  The current settings are displayed.



→  Confirm.

→  **Inverse quadratic**



→  Confirm.

→   Set the value of constant *a* of the quadratic curve, in the displayed units (mm²/s), and in the scientific notation. For example, to set the value 0.03724, enter 3.724000E-02 or, to set the value 372.4, enter 3.724000E+02.

→  Confirm.

→   Set the value of constant *b* of the quadratic curve, in the displayed units, and in the scientific notation.

→  Confirm.

→   Set the value of constant *c* of the quadratic curve, in the displayed units, and in the scientific notation.

→  Confirm.

→  Save.

 The compensation for a liquid with an inverse quadratic compensation curve is active.









If the calculated result of the equation is negative or equal to 0 (for example if the liquid temperature is not in the range covered by the equation, or if wrong constant values have been entered), the compensated volume flow is incorrect and the error message **Viscosity compensation failed** is displayed. If the message is displayed, do the following:

→ Make sure the liquid temperature is in the range covered by the equation.

→ Make sure you have entered correct constant values.

15.15.6 Resetting the default values of the viscosity compensation parameters

To reset the default values of the viscosity compensation parameters, do the following:

- Go to the **CONFIGURATION** view.
-  **SAW sensor**
-  Confirm to access the **Parameter** view.
-  **Viscosity compensation** -----> 
-  **Reset to default** -----> 
-  Confirm.
- ✔ The viscosity compensation parameters are reset.
-  Go back to the parent menu.

15.16 Setting the refresh time

15.16.1 Use case of the refresh time

The refresh time is the minimum time needed to update a measurement value. The refresh time has no effect on the damping of the measured values.

The refresh time of the temperature values is a constant but the refresh time of the other measurement values can be adapted to the process:

- A very short refresh time is needed if the process requires quick measurement updates, for example for very short dosings.
- A long refresh time is sufficient if for example there are slow flow rate changes in the process.

15.16.2 Changing the refresh time

3 refresh times are available:

- a **Long** refresh time, i.e. the duration between 2 measurement updates is approximately 100 ms.
- a **Short** refresh time, i.e. the duration between 2 measurement updates is approximately 70 ms. Default setting.
- a **Very short** refresh time, i.e. the duration between 2 measurement updates is approximately 30 ms.



If the very short refresh time is set:

- The diagnostics event **Not totally filled** is not available.
- The measurement deviation for a flow rate between 10 % of the full scale and the full scale is ± 0.6 %.
- The repeatability for a flow rate between 10 % of the full scale and the full scale is ± 0.3 %.



If a digital output is configured as a pulse output, the following durations must be added to the last received pulse:

- 50 ms, if the refresh time is set to **Very short**,
- 80 ms, if the refresh time is set to **Short**,
- 140 ms, if the refresh time is set to **Long**.

To change the refresh time, do the following:

→ Go to the **CONFIGURATION** view.

→  **SAW sensor**

→  Confirm to access the **Parameter** view.

→  **Refresh time** -----> .

→  Choose the refresh time.

→  Save.

 The refresh time is changed.









Menu **SAW sensor** – **DIAGNOSTICS**

16	SAW SENSOR – DIAGNOSTICS	250
16.1	Reading out the generated events related to the device	250
16.2	Reading out the flow direction that has been set	250
16.3	Reading out the temperatures of the electronic boards and of the liquid	250
16.4	Reading out the refresh time that has been set	251
16.5	Reading out the operating hours of the device	251
16.6	Reading out the operating hours of the measurement board.....	252
16.7	Reading out the diagnostics related to the output values.....	252
16.8	Reading out the diagnostics events that occurred in the process.....	252
16.9	Reading out the diagnostics events that occurred on the electronics	253
16.10	Reading out the diagnostics events that occurred on the sensor	253
16.11	Reading out the diagnostic events related to the monitored limits.....	254
16.12	Reading out if a process value is in the monitored range.....	254

16 SAW SENSOR – DIAGNOSTICS









16.1 Reading out the generated events related to the device

To read out the generated events related to the monitoring of the process value limits and to the diagnostics events, and to read out the possible associated behaviour of the device, do the following:

- Go to the **CONFIGURATION** view.
-  **SAW sensor**
-  Confirm to access the **Parameter** view.
-  Go to the **DIAGNOSTICS** view.
-  **Device** -----> 
-  **Status** -----> 
-  Go back to the parent menu.

16.2 Reading out the flow direction that has been set







To read out the flow direction that has been set in chapter [17.4 Setting the direction of the flow](#), do the following:

- Go to the **CONFIGURATION** view.
-  **SAW sensor**
-  Confirm to access the **Parameter** view.
-  Go to the **DIAGNOSTICS** view.
-  **Device** -----> 
-  **Flow direction** -----> 
-  Go back to the parent menu.

16.3 Reading out the temperatures of the electronic boards and of the liquid









To read out the measured temperatures of the electronic boards and of the liquid, do the following:

- Go to the **CONFIGURATION** view.
-  **SAW sensor**

-  Confirm to access the **Parameter** view.
-  Go to the **DIAGNOSTICS** view.
-  **Device** -----> 
-  **Temperatures** -----> 
-  Go back to the parent menu.









16.4 Reading out the refresh time that has been set

To read out the refresh time that has been set in chapter [15.16 Setting the refresh time](#), do the following:

- Go to the **CONFIGURATION** view.
-  **SAW sensor**
-  Confirm to access the **Parameter** view.
-  Go to the **DIAGNOSTICS** view.
-  **Device** -----> 
-  **Refresh time** -----> 
-  Go back to the parent menu.









16.5 Reading out the operating hours of the device

To read out the operating hours of the device, do the following:

- Go to the **CONFIGURATION** view.
-  **SAW sensor**
-  Confirm to access the **Parameter** view.
-  Go to the **DIAGNOSTICS** view.
-  **Device** -----> 
-  **Operating hours** -----> 
-  Go back to the parent menu.







16.6 Reading out the operating hours of the measurement board

To read out the operating hours of the measurement board, do the following:

- Go to the **CONFIGURATION** view.
-  **SAW sensor**
-  Confirm to access the **Parameter** view.
-  Go to the **DIAGNOSTICS** view.
-  **Device** -----> 
-  **Operating hours (measurement board)** -----> 
-  Go back to the parent menu.



16.7 Reading out the diagnostics related to the output values







The outputs values give the values of the process values at a certain time. See chapter 18. To read out diagnostics related to the output values, do the following:

- Go to the **CONFIGURATION** view.
-  **SAW sensor**
-  Confirm to access the **Parameter** view.
-  Go to the **DIAGNOSTICS** view.
-  **Output value** -----> 
-  Go back to the parent menu.

16.8 Reading out the diagnostics events that occurred in the process











To read out the diagnostics events that occurred in the process, and to read out the possible associated behaviour of the device, do the following:

- Go to the **CONFIGURATION** view.
-  **SAW sensor**
-  Confirm to access the **Parameter** view.
-  Go to the **DIAGNOSTICS** view.

-  **Diag. events** -----> 
-  **Process** -----> 
-  **Status** -----> 
-  Go back to the parent menu.











16.9 Reading out the diagnostics events that occurred on the electronics

To read out the diagnostics events that occurred on the electronics, and to read out the possible associated behaviour of the device, do the following:

- Go to the **CONFIGURATION** view.
-  **SAW sensor**
-  Confirm to access the **Parameter** view.
-  Go to the **DIAGNOSTICS** view.
-  **Diag. events** -----> 
-  **Electronic** -----> 
-  **Status** -----> 
-  Go back to the parent menu.









16.10 Reading out the diagnostics events that occurred on the sensor

To read out the status of the diagnostics events that occurred on the sensor, do the following:

- Go to the **CONFIGURATION** view.
-  **SAW sensor**
-  Confirm to access the **Parameter** view.
-  Go to the **DIAGNOSTICS** view.
-  **Diag. events** -----> 
-  **Sensor** -----> 
-  **Status** -----> 
-  Go back to the parent menu.

16.11 Reading out the diagnostic events related to the monitored limits









To read out the diagnostics related to the monitored limits, do the following:

- Go to the **CONFIGURATION** view.
-  **SAW sensor**
-  Confirm to access the **Parameter** view.
-  Go to the **DIAGNOSTICS** view.
-  **Limits** -----> 
-  **Status** -----> 
-  Go back to the parent menu.

16.12 Reading out if a process value is in the monitored range

This menu point allows you to read out if a process-value is inside or outside its monitored limits. The monitoring of the process-value limits must be active. Refer to chpt .[15.4.5](#), [15.6.5](#) and [15.8.5](#).

To read out if a process-value is inside or outside its monitored limits do the following:

- Go to the **CONFIGURATION** view.
-  **SAW sensor**
-  Confirm to access the **Parameter** view.
-  Go to the **DIAGNOSTICS** view.
-  **Limits** -----> 
- Choose the process value -----> 
-  **Status** -----> 
-  Go back to the parent menu.

Menu **SAW sensor** – **MAINTENANCE**

17	SAW SENSOR – MAINTENANCE.....	257
17.1	User levels of the editable menu items	257
17.2	Default settings	257
17.3	Reading out some device information	257
17.3.1	Reading out the ordering codes of the device, the transmitter board and the measurement board	257
17.3.2	Reading out the serial numbers of the device, the transmitter board and the measurement board	258
17.3.3	Reading out the hardware and software versions of the transmitter board and of the measurement board.....	258
17.3.4	Reading out the characteristics of the measurement tube	258
17.3.5	Checking the correct operation of the sensor	259
17.3.6	Reading out the calibration date at the manufacturer	260
17.3.7	Reading out the liquid type and the liquid temperature during calibration at the manufacturer	261
17.3.8	Reading out the raw measured value of the volume flow rate	261
17.4	Setting the direction of the flow	262
17.5	Calibrating the offset value of the flow zero point.....	262
17.6	Setting the offset value of the flow zero point.....	263
17.7	Setting the K factor.....	264
17.8	Calibrating the K factor by using a teach-in procedure	264
17.8.1	Calibrating the K factor by using a teach-in procedure depending on the volume flow rate	265
17.8.2	Calibrating the K factor by using a teach-in procedure depending on a known volume	266
17.8.3	Calibrating the K factor by using a teach-in procedure depending on the mass flow rate.....	267
17.8.4	Calibrating the K factor by using a teach-in procedure depending on a known mass.....	268
17.9	Resetting the flow rate calibration data to its default values.....	270
17.10	Setting the offset value of the liquid temperature	270
17.11	Calibrating the offset value of the liquid temperature	271
17.12	Resetting the offset of the liquid temperature to its default value	272
17.13	Resetting all the calibration data to its default values (standard measurement values)	272
17.14	Setting the offset value of the differentiation factor.....	273

MAN 1000273158 EN Version: M Status: RL (released | freigegeben) printed: 22.06.2022

17.15	Calibrating the offset value of the differentiation factor.....	273
17.16	Setting the slope value of the differentiation factor	274
17.17	Setting the offset value of the liquid density	275
17.18	Setting the slope value of the liquid density.....	275
17.19	Calibrating the liquid density by using a teach-in procedure depending on density	276
17.20	Setting the offset value of the liquid concentration	276
17.21	Calibrating the offset value of the liquid concentration	277
17.22	Setting the slope value of the liquid concentration.....	278
17.23	Setting the offset value of the acoustic transmission factor	279
17.24	Calibrating the offset value of the acoustic transmission factor	279
17.25	Setting the slope value of the acoustic transmission factor.....	281
17.26	Resetting all the calibration data to its default values (additional measurement values)	282
17.27	Checking the correct behaviour of the device	283
17.27.1	Choosing the process values to be simulated	283
17.27.2	Checking the behaviour of the device by simulating an event.....	284
17.27.3	Stopping the simulation of process values and events.....	285

17 SAW SENSOR – MAINTENANCE

17.1 User levels of the editable menu items

Menu item of the SAW sensor – Maintenance menu	Minimum user level
Device information	basic user
Flow direction	Installer
Calibration	Installer
Device verification	Installer
Simulation	Installer

17.2 Default settings









You can find the default settings of the device in the CANopen supplement for the Type 8098 FLOWave L at country.burkert.com.

→ Before making any change in the settings, use the Bürkert Communicator software to print a pdf file with all the default settings of the device.

17.3 Reading out some device information









17.3.1 Reading out the ordering codes of the device, the transmitter board and the measurement board

To read out the ordering codes of the device, the transmitter board and the measurement board, do the following:

- Go to the **CONFIGURATION** view.
-  **SAW sensor**
-  Confirm to access the **Parameter** view.
-  Go to the **MAINTENANCE** view.
-  **Device information** -----> 
-  **ID numbers** -----> 
-  Go back to the parent menu.









17.3.2 Reading out the serial numbers of the device, the transmitter board and the measurement board

To read out the serial numbers of the device, the transmitter board and the measurement board, do the following:

- Go to the **CONFIGURATION** view.
-  **SAW sensor**
-  Confirm to access the **Parameter** view.
-  Go to the **MAINTENANCE** view.
-  **Device information** -----> 
-  **Serial numbers** -----> 
-  Go back to the parent menu.









17.3.3 Reading out the hardware and software versions of the transmitter board and of the measurement board

To read out the hardware and software versions of the transmitter board and of the measurement board, do the following:

- Go to the **CONFIGURATION** view.
-  **SAW sensor**
-  Confirm to access the **Parameter** view.
-  Go to the **MAINTENANCE** view.
-  **Device information** -----> 
-  **Versions** -----> 
-  Go back to the parent menu.

17.3.4 Reading out the characteristics of the measurement tube

To read out the characteristics of the measurement tube, do the following:

- Go to the **CONFIGURATION** view.
-  **SAW sensor**
-  Confirm to access the **Parameter** view.
-  Go to the **MAINTENANCE** view.
-  **Device information** -----> 
-  **Pipe characteristics** -----> 
-  Go back to the parent menu.

17.3.5 Checking the correct operation of the sensor

You can check the correct operation of the sensor by comparing the current measured values of some parameters with their reference values. The reference values depend on the conditions of your process:

- If you measure water at 23 °C ±5 °C (73.4 °F ±9 °F) that is free of gas bubbles and free of solids, then the conditions of your process are similar to the calibration conditions of the device at the manufacturer. The reference values are those after the device calibration and they can be read in the menu **Device verification**.
- If you do not measure water at 23 °C ±5 °C (73.4 °F ±9 °F), then the reference values are in the report that you have generated with the Bürkert Communicator software at the following moments:
 - after the first commissioning of the device. Refer to chapter 9.
 - after the last maintenance operation

To check the correct operation of the sensor, do the following:

1. If you do not measure water at 23 °C ±5 °C (73.4 °F ±9 °F), then get the report with the reference values.

2. Access the menu **Device verification**:

→ Go to the **CONFIGURATION** view.

→ **SAW sensor**

→ Confirm to access the **Parameter** view.

→ Go to the **MAINTENANCE** view.

→ **Device verification** -----> .

The values of the parameters are displayed.

3. Calculate the deviation for each parameter that is listed in [Table 35](#) or in [Table 36](#). Use the following formula:

$$| \text{current measured value} - \text{reference value} | / \text{reference value} = \text{deviation}$$

- If you measure water at 23 °C ±5 °C (73.4 °F ±9 °F) that is free of gas bubbles and free of solids, then use the values that are displayed in the parameters from columns A and B of [Table 35](#).

Table 35: Parameter values to compare if the measured liquid is water at 23 °C ±5 °C (73.4 °F ±9 °F)

Menu item	A	B
	Current measured value of the parameter	Reference value of the parameter after calibration at the manufacturer
DF	DF	DF fact. cal.
Acoustic transmission factor	Acoustic transmission factor	Acoustic transmission factor fact. cal.
Amplitudes	SAW signal	SAW signal fact. calibration
	Signal WG1 13	Signal WG1 13 fact. calibration
Times of flight	A0	A0 fact. calibration
	WG1	WG1 fact. calibration

- If you do not measure water at 23 °C ±5 °C (73.4 °F ±9 °F), then use the values of the same parameter in the menu **Device verification** on the display and in the report. Refer to [Table 36](#).

Table 36: Parameter values to compare if the measured liquid is not water at 23 °C ±5 °C (73.4 °F ±9 °F)

Menu item	Current measured value of the Parameter in the menu Device verification on the display and in the report
DF	DF
Acoustic transmission factor	Acoustic transmission factor
Amplitudes	SAW signal
	Signal WGx yz
Times of flight	A0
	WGx

4. Evaluate the deviations of all parameters:









- If the deviations of all parameters are less than the values that are given in [Table 37](#), then the sensor operates correctly.
- If the deviation of at least one parameter exceeds the value that is given in [Table 37](#), then the sensor can possibly be defect. Contact Bürkert.

Table 37: Deviation values for a defect sensor

Parameters	Deviation
DF	> 10 %
Acoustic transmission factor	> 25 %
Amplitudes	SAW signal
	Signal WGx yz
Times of flight	A0
	WGx











17.3.6 Reading out the calibration date at the manufacturer

To read out the calibration date of the device at the manufacturer, do the following:

- Go to the **CONFIGURATION** view.
-  **SAW sensor**
-  Confirm to access the **Parameter** view.
-  Go to the **MAINTENANCE** view.
-  **Device verification** -----> 
-  **Factory calibration** -----> **Date** -----> 
-  Go back to the parent menu.









17.3.7 Reading out the liquid type and the liquid temperature during calibration at the manufacturer

To read out the type of liquid and the temperature of the liquid used for the calibration of the device at the manufacturer, do the following:

- Go to the **CONFIGURATION** view.
-  **SAW sensor**
-  Confirm to access the **Parameter** view.
-  Go to the **MAINTENANCE** view.
-  **Device verification** -----> 
-  **Factory calibration** -----> **Medium** -----> 
-  **Factory calibration** -----> **Medium temperature** -----> 
-  Go back to the parent menu.

17.3.8 Reading out the raw measured value of the volume flow rate

The raw value of the volume flow rate is a value that is not damped and to which the active cut-off is not applied. To read out the raw value of the volume flow rate, do the following:

- Go to the **CONFIGURATION** view.
-  **SAW sensor**
-  Confirm to access the **Parameter** view.
-  Go to the **MAINTENANCE** view.
-  **Device verification** -----> 
-  **Volume flow** -----> **Undamped without cut-off** -----> 
-  Go back to the parent menu.

17.4 Setting the direction of the flow

By default, if the flow direction is opposite the arrow located on the front of the device, the displayed flow rate values are negative.

If you want that the device displays positive flow rate values, do the following:

→ Go to the **CONFIGURATION** view.

→  **SAW sensor**

→  Confirm to access the **Parameter** view.

→  Go to the **MAINTENANCE** view.

→  **Flow direction** -----> 

→  Choose **Standard** if the arrow located on the front of the device shows the flow direction, or choose **Reverse** if the flow direction is opposite the arrow located on the front of the device.

→  Save.

 The flow direction is set and the displayed flow rate values are positive.

17.5 Calibrating the offset value of the flow zero point



Adjust this parameter:

- before carrying out a teach-in procedure of the K factor.
- after maintenance work.
- if the measured flow rate is not zero whereas the flow has been stopped.



During the calibration:

- The device status indicator is orange, if the operating mode of the device status indicator is set to NAMUR (ex-works setting, see chapter [12.4 Changing the operating mode of the device status indicator or switching off the device status indicator](#)).
- The NAMUR mode "function check" is active. The outputs react depending on your settings.

Instead of calibrating the offset value of the flow zero point, you can directly set it. See chapter [17.6 Setting the offset value of the flow zero point](#).

To calibrate the flow zero point, do the following:

→ Charge the pipe. To avoid bubbles and air in the pipe, make sure it is full of liquid.

→ Go to the **CONFIGURATION** view.

→  **SAW sensor**

→  Confirm to access the **Parameter** view.

→  Go to the **MAINTENANCE** view.

→  **Calibration** -----> 

- **Stand. meas. values** ----->
- **Flow rate** ----->
- **Offset** ----->
- **Zero flow offset by teach-in** -----> -----> The **Current settings** are displayed.
- Stop the flow and wait until it is completely still. -----> Start the calibration of the offset value.
-----> After 30 s, the **New settings** are displayed.
- Save.

The offset value of the flow zero point is calibrated.

If the calibration fails, a message is displayed. Refer to chapter [24.10 Messages due to calibration or simulation](#).

- Acknowledge the message to go back to the parent menu.

17.6 Setting the offset value of the flow zero point

Instead of setting the offset value of the flow zero point, you can calibrate it. See chapter [17.5 Calibrating the offset value of the flow zero point](#).

To enter the offset value of the flow zero point, do the following:

- Go to the **CONFIGURATION** view.
- **SAW sensor**
- Confirm to access the **Parameter** view.
- Go to the **MAINTENANCE** view.
- **Calibration** ----->
- **Stand. meas. values** ----->
- **Flow rate** ----->
- **Offset** ----->
- **Enter value** ----->
- Set the value of the offset. Take into account the direction of the flow as set in chapter [17.4 Setting the direction of the flow](#)
- Save.

The offset value of the flow zero point is set.

17.7 Setting the K factor

By default, the value of the K factor is 1.0000.

The K factor can be adjusted, if the measured flow rate values differ from the real values.

Instead of setting the K factor, you can calibrate it by using a teach-in procedure. See chapter [17.8 Calibrating the K factor by using a teach-in procedure](#).

To enter the value of the K factor, do the following:

→ Go to the **CONFIGURATION** view.

→  **SAW sensor**

→  Confirm to access the **Parameter** view.

→  Go to the **MAINTENANCE** view.

→  **Calibration** -----> 

→  **Stand. meas. values** -----> 

→  **Flow rate** -----> 

→  **K factor** -----> 

→  **Enter value** -----> 

→   Set the value of the K factor.

→  Save.

 The new K factor value is used.

17.8 Calibrating the K factor by using a teach-in procedure



Before any teach-in procedure, calibrate or set the offset value flow zero point of the device. See chapter [17.5 Calibrating the offset value of the flow zero point](#) or [17.6 Setting the offset value of the flow zero point](#).

By default, the value of the K factor is 1.0000.

The K factor should be adjusted, if the flow rate values that are measured by the device differ from the values that are measured by a reference instrument.

The K factor can be:

- manually adjusted. See chapter [17.7 Setting the K factor](#).
- automatically calibrated by using a teach-in procedure depending on the flow rate.
- automatically calibrated by using a teach-in procedure depending on a known volume.

17.8.1 Calibrating the K factor by using a teach-in procedure depending on the volume flow rate

→ Make sure the teach-in conditions are similar to those of the process.

→ In order that the calibration result is correct, make sure the following conditions are met during the teach-in procedure:

- the liquid temperature is stable,
- the flow rate is stable,
- the liquid that flows through the device does not change.

To calibrate the K factor by using a teach-in procedure depending on the flow rate, do the following:

→ Make sure a reference flowmeter is installed in the same pipe as the FLOWave.

→ Charge the pipe. The flow rate must be at least 5 % of the full scale.

→ Wait for the flow rate to be stable.

→ Go to the **CONFIGURATION** view.

→  **SAW sensor**

→  Confirm to access the **Parameter** view.

→  Go to the **MAINTENANCE** view.

→  **Calibration** ----- 

→  **Stand. meas. values** ----- 



→  **Flow rate** -----  -----  **K factor** ----- 

→  **Teach-in by volume flow** -----  ----- The current K factor is displayed.

→  Start the teach-in procedure.

 If the cut-off function is enabled, it is automatically deactivated.

→ Wait for about 30 s: the device is averaging the flow rate.

→   After 30 s, enter the average value of the flow rate that has been measured by the reference flowmeter.

→  The **New settings** are displayed.

→  Save.

 The new K factor is used.

 If the cut-off function has been automatically deactivated, it is enabled again.

If the calibration fails, a message is displayed. Refer to chapter [24.10 Messages due to calibration or simulation](#).

→  Acknowledge the message to go back to the parent menu.

17.8.2 Calibrating the K factor by using a teach-in procedure depending on a known volume

→ Make sure the teach-in conditions are similar to those of the process.

To calibrate the K factor by using a teach-in procedure depending on a known volume, do the following:

→ Prepare a tank which capacity you know. To make sure to get an accurate K factor, prepare the recommended volume of liquid given in [Table 38](#) or in [Table 39](#).

Table 38: Recommended volume for a teach-in procedure depending on a known volume

Diameter of the measurement tube	Minimum flow rate at 4 m/s	Recommended volume, in litres, to get an accurate K factor
3/8"	11 l/min.	19
1/2"	17 l/min.	28
DN8	20 l/min.	33

Table 39: Recommended volume for a teach-in procedure depending on a known volume

Diameter of the measurement tube	Minimum flow rate at 1 m/s	Recommended volume, in litres, to get an accurate K factor
3/4"	12 l/min.	19
1"	23 l/min.	38
1 1/2"	57 l/min.	95
2"	106 l/min.	177
2 1/2"	171 l/min.	285
3"	250 l/min.	417
DN15	15 l/min.	26
DN25	42 l/min.	69
DN40	92 l/min.	154
DN50	149 l/min.	249
DN65	245 l/min.	408
DN80	355 l/min.	472

→ Stop the flow.

→ Go to the **CONFIGURATION** view.

→  **SAW sensor**











→  Confirm to access the **Parameter** view.

→  Go to the **MAINTENANCE** view.







→  **Calibration** -----> 

→  **Stand. meas. values** -----> 

→  **Flow rate** -----> 

-  **K factor** -----> 
 -  **Teach-in by volume** ----->  -----> The current K factor is displayed.
 -  Start the teach-in procedure.
 - ✓ If the cut-off function is enabled, it is automatically deactivated.
 - Let the liquid flow through the device into the tank. When the desired volume is reached -----> 
 -   Enter the volume that has flown in the tank. ----->  -----> The **New settings** are displayed.
 -  Save.
 - ✓ The new K factor is used.
 - ✓ If the cut-off function has been automatically deactivated, it is enabled again.
- If the calibration fails, a message is displayed. Refer to chapter [24.10 Messages due to calibration or simulation](#).
-  Acknowledge the message to go back to the parent menu.

17.8.3 Calibrating the K factor by using a teach-in procedure depending on the mass flow rate

- Make sure the teach-in conditions are similar to those of the process.
- In order that the calibration result is correct, make sure the following conditions are met during the teach-in procedure:
 - the liquid temperature is stable,
 - the mass flow rate is stable,
 - the liquid that flows through the device does not change.
- To calibrate the K factor by using a teach-in procedure depending on the mass flow rate, do the following:
 - Make sure a reference flowmeter is installed in the same pipe as the FLOWave.
 - Charge the pipe. The mass flow rate must be at least 5 % of the full scale.
 - Wait for the mass flow rate to be stable.
 - Go to the **CONFIGURATION** view.
 -  **SAW sensor**
 -  Confirm to access the **Parameter** view.
 -  Go to the **MAINTENANCE** view.
 -  **Calibration** -----> 
 -  **Stand. meas. values** -----> 



→ Teach-in by mass flow rate → The current K factor is displayed.

→ Start the teach-in procedure.

✓ If the cut-off function is enabled, it is automatically deactivated.

→ Wait for about 30 s: the device is averaging the mass flow rate.

→ After 30 s, enter the average value of the mass flow rate that has been measured by the reference flowmeter.

→ The **New settings** are displayed.

→ Save.

✓ The new K factor is used.

✓ If the cut-off function has been automatically deactivated, it is enabled again.

If the calibration fails, a message is displayed. Refer to chapter [24.10 Messages due to calibration or simulation](#).

→ Acknowledge the message to go back to the parent menu.

17.8.4 Calibrating the K factor by using a teach-in procedure depending on a known mass

→ Make sure the teach-in conditions are similar to those of the process.

To calibrate the K factor by using a teach-in procedure depending on a known mass, do the following:

→ Prepare a tank which capacity you know. To make sure to get an accurate K factor, prepare the recommended mass of liquid given in [Table 40](#) or in [Table 41](#).

Table 40: Recommended mass for a teach-in procedure depending on a known mass

Diameter of the measurement tube	Minimum flow rate at 4 m/s	Recommended mass, in kg, to get an accurate K factor
3/8"	11 l/min.	19 × liquid density
1/2"	17 l/min.	28 × liquid density
DN8	20 l/min.	33 × liquid density

Table 41: Recommended mass for a teach-in procedure depending on a known mass

Diameter of the measurement tube	Minimum flow rate at 1 m/s	Recommended mass, in kg, to get an accurate K factor
3/4"	12 l/min.	19 × liquid density
1"	23 l/min.	38 × liquid density
1 1/2"	57 l/min.	95 × liquid density
2"	106 l/min.	177 × liquid density
2 1/2"	171 l/min.	285 × liquid density
3"	250 l/min.	417 × liquid density

Diameter of the measurement tube	Minimum flow rate at 1 m/s	Recommended mass, in kg, to get an accurate K factor
DN15	15 l/min.	26 × liquid density
DN25	42 l/min.	69 × liquid density
DN40	92 l/min.	154 × liquid density
DN50	149 l/min.	249 × liquid density
DN65	245 l/min.	408 × liquid density
DN80	355 l/min.	472 × liquid density

→ Stop the flow.

→ Go to the **CONFIGURATION** view.



→  **SAW sensor**

→  Confirm to access the **Parameter** view.

→  Go to the **MAINTENANCE** view.

→  **Calibration** -----> 

→  **Stand. meas. values** -----> 

→  **Flow rate** -----> 



→  **K factor** -----> 

→  **Teach-in by mass** ----->  -----> The current K factor is displayed.

→  Start the teach-in procedure.

 If the cut-off function is enabled, it is automatically deactivated.

→ Let the liquid flow through the device into the tank. When the desired mass is reached -----> 

→   Enter the mass that has flown in the tank. ----->  -----> The **New settings** are displayed.

→  Save.

 The new K factor is used.













 If the cut-off function has been automatically deactivated, it is enabled again.

If the calibration fails, a message is displayed. Refer to chapter [24.10 Messages due to calibration or simulation](#).

→  Acknowledge the message to go back to the parent menu.

17.9 Resetting the flow rate calibration data to its default values

















To reset all the flow rate calibration data to its default values, do the following:

- Go to the **CONFIGURATION** view.
-  **SAW sensor**
-  Confirm to access the **Parameter** view.
-  Go to the **MAINTENANCE** view.
-  **Calibration** -----> 
-  **Stand. meas. values** -----> 
-  **Flow rate** -----> 
-  **Reset to default** ----->  ----->  Confirm.
- ✓ All the flow rate calibration data is reset to their default values.
-  Go back to the parent menu.

17.10 Setting the offset value of the liquid temperature

Instead of setting the offset value of the liquid temperature, you can calibrate it. See chapter [17.11 Calibrating the offset value of the liquid temperature](#).

To enter an offset value for the liquid temperature, do the following:

- Go to the **CONFIGURATION** view.
-  **SAW sensor**
-  Confirm to access the **Parameter** view.
-  Go to the **MAINTENANCE** view.
-  **Calibration** -----> 
-  **Stand. meas. values** -----> 
-  **Temperature** -----> 
-  **Offset** ----->  ----->  **Enter value** -----> 
-   Set the value of the offset.
-  Save.
- ✓ The offset value of the liquid temperature is set.

17.11 Calibrating the offset value of the liquid temperature

Instead of calibrating the offset value of the liquid temperature, you can directly enter it. See chapter [17.10 Setting the offset value of the liquid temperature](#).

To calibrate the offset value of the liquid temperature, do the following:

→ Make sure a reference temperature sensor is installed in the same pipe as the FLOWave and as near as possible to the FLOWave.

→ Charge the pipe.

→ Go to the **CONFIGURATION** view.

→  **SAW sensor**

→  Confirm to access the **Parameter** view.

→  Go to the **MAINTENANCE** view.

→  **Calibration** -----> 

→  **Stand. meas. values** -----> 

→  **Temperature** -----> 



→  **Offset** -----> 

→ Make sure the calibration conditions (liquid temperature and ambient temperature) are the same as for the usual measuring conditions.

→ Make sure the temperature of the liquid is constant and stable during the calibration procedure.

→  **Temper. cal. by ref.** ----->  -----> The current offset is displayed.

→  Start the calibration procedure.

→   After 30 s, enter the average value of the liquid temperature that has been measured by the reference temperature sensor.

→  The **New settings** are displayed.

→  Save.

 The new temperature offset is used.













If the calibration fails, a message is displayed. Refer to chapter [24.10 Messages due to calibration or simulation](#). The calibration can fail due to the following causes:

- the calculated offset value is higher than ± 10 °C.
- the integrated temperature sensor is defective.

→  Acknowledge the message to go back to the parent menu.

17.12 Resetting the offset of the liquid temperature to its default value

To reset the offset of the liquid temperature to its default value, do the following:











- Go to the **CONFIGURATION** view.
-  **SAW sensor**
-  Confirm to access the **Parameter** view.
-  Go to the **MAINTENANCE** view.
-  **Calibration** -----> 
-  **Stand. meas. values** -----> 
-  **Temperature** -----> 
-  **Reset to default** ----->  ----->  Confirm.
- ✔ The temperature offset is reset to its default value.
-  Go back to the parent menu.

17.13 Resetting all the calibration data to its default values (standard measurement values)

The calibration data that can be reset is:

- the K factor,
- the offset value of the flow zero point,
- the offset value of the liquid temperature.

To reset all the calibration data to its default values, do the following:

- Go to the **CONFIGURATION** view.
-  **SAW sensor**
-  Confirm to access the **Parameter** view.
-  Go to the **MAINTENANCE** view.
-  **Calibration** -----> 
-  **Stand. meas. values** -----> 
-  **Reset to default** -----> 
-  Confirm.
- ✔ All the calibration data is reset to their default values.
-  Go back to the parent menu.

17.14 Setting the offset value of the differentiation factor

Instead of setting the offset value of the DF, you can calibrate it. See chapter [17.15](#).

To enter an offset value for the DF, do the following:

→ Go to the **CONFIGURATION** view.

→  **SAW sensor**

→  Confirm to access the **Parameter** view.

→  Go to the **MAINTENANCE** view.



→  **Calibration** -----> 

→  **Add. meas. values** -----> 

→  **DF** -----> 

→  **Offset** -----> 

→  **Enter value** -----> 

→   Set the value of the offset.

→  Save.

 The offset value of the DF is set.

17.15 Calibrating the offset value of the differentiation factor

→ Make sure the teach-in conditions are similar to those of the process.

→ To get a correct calibration result, make sure that the following conditions are met during the teach-in procedure:

- The liquid temperature is stable.
- The liquid that flows through the device does not change. Or the liquid is still and the pipe is full and free of bubbles.



During the calibration:



















- The device status indicator is orange, if the operating mode of the device status indicator is set to NAMUR (ex-works setting, see chapter [12.4 Changing the operating mode of the device status indicator or switching off the device status indicator](#)”).
- The NAMUR mode "function check" is active. The outputs react depending on your settings.

Instead of calibrating the offset value of the DF, you can directly set it. See chapter [17.14](#).

To calibrate the offset value of the DF, do the following:

→ Make sure the liquid in the pipe is the liquid to be measured.

→ Charge the pipe. To avoid bubbles and air in the pipe, make sure it is full of liquid.













- Go to the **CONFIGURATION** view.
-  **SAW sensor**
-  Confirm to access the **Parameter** view.
-  Go to the **MAINTENANCE** view.
-  **Calibration** -----> 
-  **Add. meas. values** -----> 
-  **DF** -----> 
-  **Offset** -----> 
-  **Teach-in by reference** ----->  -----> The **Current settings** are displayed.
-  Start the calibration of the offset value.
-   After 30 s, enter the DF of the reference liquid. -----> 
-----> The **New settings** are displayed.
-  Save.
-  The offset value of the DF is calibrated.

If the calibration fails, a message is displayed. Refer to chapter [24.10 Messages due to calibration or simulation](#).

-  Acknowledge the message to go back to the parent menu.

17.16 Setting the slope value of the differentiation factor

To enter a slope value for the DF, do the following:

- Go to the **CONFIGURATION** view.
-  **SAW sensor**
-  Confirm to access the **Parameter** view.
-  Go to the **MAINTENANCE** view.
-  **Calibration** -----> 
-  **Add. meas. values** -----> 
-  **DF** -----> 
-  **Slope** -----> 
-  **Enter value** -----> 

→  Set the slope value.

→  Save.

 The slope value of the DF is set.

17.17 Setting the offset value of the liquid density

Instead of setting the offset value of the liquid density, you can calibrate it. See chapter [17.19](#).

To enter an offset value for the liquid density, do the following:

→ Go to the **CONFIGURATION** view.

→  **SAW sensor**

→  Confirm to access the **Parameter** view.

→  Go to the **MAINTENANCE** view.

→  **Calibration** -----> 

→  **Stand. meas. values** -----> 

→  **Density** -----> 

→  **Offset** -----> 

→  **Enter value** -----> 

→  Set the value of the offset.

→  Save.

 The offset value of the liquid density is set.

17.18 Setting the slope value of the liquid density

To enter a slope value for the liquid density, do the following:

→ Go to the **CONFIGURATION** view.

→  **SAW sensor**







→  Confirm to access the **Parameter** view.

→  Go to the **MAINTENANCE** view.

→  **Calibration** -----> 

→  **Stand. meas. values** -----> 



















→  **Density** -----> 

-  Slope -----> 
-  Enter value -----> 
-   Set the slope value.
-  Save.

 The slope value of the liquid density is set.

17.19 Calibrating the liquid density by using a teach-in procedure depending on density

To calibrate the liquid density, do the following:















- Go to the **CONFIGURATION** view.
-  **SAW sensor**
-  Confirm to access the **Parameter** view.
-  Go to the **MAINTENANCE** view.
-  **Calibration** -----> 
-  **Stand. meas. values** -----> 
-  **Density** -----> 
-  **Teach-in by density** ----->  -----> The current **da coefficient** is displayed.
-  Start the teach-in procedure.
-   When asked, enter the density of the liquid. ----->  -----> The **New settings** are displayed.
-  Save.
-  The new da coefficient is now used.
-  Acknowledge the message to go back to the parent menu.

17.20 Setting the offset value of the liquid concentration

Instead of setting the offset value of liquid concentration 1 or liquid concentration 2, you can calibrate it. See chapter [17.21](#).

To enter an offset value for liquid concentration 1 or liquid concentration 2, do the following:

- Go to the **CONFIGURATION** view.
-  **SAW sensor**

-  Confirm to access the **Parameter** view.
-  Go to the **MAINTENANCE** view.
-  **Calibration** -----> 
-  **Add. meas. values** -----> 
-  **Concentration 1** or **Concentration 2** -----> 
-  **Offset** -----> 
-  **Enter value** -----> 
-   Set the value of the offset.
-  Save.
- ✔ The offset value of the selected liquid concentration is set.

17.21 Calibrating the offset value of the liquid concentration

- Make sure the teach-in conditions are similar to those of the process.
- To get a correct calibration result, make sure that the following conditions are met during the teach-in procedure:
 - The liquid temperature is stable.
 - The liquid that flows through the device does not change. Or the liquid is still and the pipe is full and free of bubbles.























During the calibration:

- The device status indicator is orange, if the operating mode of the device status indicator is set to NAMUR (ex-works setting, see chapter [12.4 Changing the operating mode of the device status indicator or switching off the device status indicator](#)).
- The NAMUR mode "function check" is active. The outputs react depending on your settings.

Instead of calibrating the offset value of the liquid concentration, you can directly set it. See chapter [17.20](#).

















To calibrate the offset value of liquid concentration 1 or liquid concentration 2, do the following:

- Make sure the liquid in the pipe is the liquid to be measured.
- Charge the pipe. To avoid bubbles and air in the pipe, make sure it is full of liquid.
- Go to the **CONFIGURATION** view.
-  **SAW sensor**
-  Confirm to access the **Parameter** view.
-  Go to the **MAINTENANCE** view.

-  Calibration -----> 
 -  Add. meas. values -----> 
 -  Concentration 1 or Concentration 2 -----> 
 -  Offset -----> 
 -  Teach-in by reference ----->  -----> The **Current settings** are displayed.
 -  Start the calibration of the offset value.
 -   After 30 s, enter the concentration of the reference liquid. ----->  -----> The **New settings** are displayed.
 -  Save.
 -  The offset value of the selected liquid concentration is calibrated.
- If the calibration fails, a message is displayed. Refer to chapter [24.10 Messages due to calibration or simulation](#).
-  Acknowledge the message to go back to the parent menu.

17.22 Setting the slope value of the liquid concentration

To enter a slope value for liquid concentration 1 or liquid concentration 2, do the following:

- Go to the **CONFIGURATION** view.
-  **SAW sensor**
-  Confirm to access the **Parameter** view.
-  Go to the **MAINTENANCE** view.
-  Calibration -----> 
-  Add. meas. values -----> 
-  Concentration 1 or Concentration 2 -----> 
-  Slope -----> 
-  Enter value -----> 
-   Set the slope value.
-  Save.
-  The slope value of the selected liquid concentration is set.

17.23 Setting the offset value of the acoustic transmission factor

Instead of setting the offset value of the acoustic transmission factor, you can calibrate it. See chapter [17.24](#).

To enter an offset value for the acoustic transmission factor, do the following:

→ Go to the **CONFIGURATION** view.

→  **SAW sensor**

→  Confirm to access the **Parameter** view.

→  Go to the **MAINTENANCE** view.



→  **Calibration** -----> 

→  **Add. meas. values** -----> 

→  **Acoustic transmission factor** -----> 

→  **Offset** -----> 

→  **Enter value** -----> 

→   Set the value of the offset.

→  Save.

 The offset value of the acoustic transmission factor is set.

17.24 Calibrating the offset value of the acoustic transmission factor

→ Make sure the teach-in conditions are similar to those of the process.

→ In order that the calibration result is correct, make sure the following conditions are met during the teach-in procedure:

- The liquid temperature is stable.
- The liquid that flows through the device does not change. Or the liquid is still and the pipe is full and free of bubbles.





















During the calibration:

- The device status indicator is orange, if the operating mode of the device status indicator is set to NAMUR (ex-works setting, see chapter [12.4 Changing the operating mode of the device status indicator or switching off the device status indicator](#)).
- The NAMUR mode "function check" is active. The outputs react depending on your settings.

















Instead of calibrating the offset value of the acoustic transmission factor, you can directly set it. See chapter [17.19](#).

To calibrate the offset value of the acoustic transmission factor, do the following:

- Make sure the liquid in the pipe is the liquid to be measured.
 - Charge the pipe. To avoid bubbles and air in the pipe, make sure it is full of liquid.
 - Go to the **CONFIGURATION** view.
 -  **SAW sensor**
 -  Confirm to access the **Parameter** view.
 -  Go to the **MAINTENANCE** view.
 -  **Calibration** -----> 
 -  **Add. meas. values** -----> 
 -  **Acoustic transmission factor** -----> 
 -  **Offset** -----> 
 -  **Teach-in by reference** ----->  -----> The **Current settings** are displayed.
 -  Start the calibration of the offset value.
 -   After 30 s, enter the acoustic transmission factor of the reference liquid. ----->  -----> The **New settings** are displayed.
 -  Save.
 - ✔ The offset value of the acoustic transmission factor is calibrated.
- If the calibration fails, a message is displayed. Refer to chapter [24.10 Messages due to calibration or simulation](#).
-  Acknowledge the message to go back to the parent menu.

17.25 Setting the slope value of the acoustic transmission factor

To enter a slope value for the acoustic transmission factor, do the following:

- Go to the **CONFIGURATION** view.
-  **SAW sensor**
-  Confirm to access the **Parameter** view.
-  Go to the **MAINTENANCE** view.
-  **Calibration** -----> 
-  **Add. meas. values** -----> 
-  **Acoustic transmission factor** -----> 
-  **Slope** -----> 
-  **Enter value** -----> 
-   Set the slope value.
-  Save.
-  The slope value of the acoustic transmission factor is set.

17.26 Resetting all the calibration data to its default values (additional measurement values)

The calibration data that can be reset is:

- the offset value of the DF,
- the slope value of the DF,
- the offset value of the liquid density,
- the slope value of the liquid density,
- the offset value of the liquid concentration,
- the slope value of the liquid concentration,
- the offset value of the acoustic transmission factor,
- the slope value of the acoustic transmission factor.

To reset all the calibration data to its default values, do the following:



→ Go to the **CONFIGURATION** view.

→  **SAW sensor**

→  Confirm to access the **Parameter** view.

→  Go to the **MAINTENANCE** view.

→  **Calibration** -----> 

→  **Add. meas. values** -----> 

→  **Reset to default** -----> 

→  Confirm.

 All the calibration data is reset to their default values.

→  Go back to the parent menu.

17.27 Checking the correct behaviour of the device

The feature allows you to check if the device has the expected behaviour depending on the settings you have made.

You can check the behaviour of the device:

- by simulating one or several process values,
- by simulating one or several events.

17.27.1 Choosing the process values to be simulated



The cut-off feature is not checked when simulating a flow rate value.

To check the behaviour by simulating a process value, do the following:

→ Go to the **CONFIGURATION** view.

→ **SAW sensor**

→ Confirm to access the **Parameter** view.

→ Go to the **MAINTENANCE** view.

→ **Simulation** ----->

→ **Meas. values** ----->

→ **Process value** ----->

→ Choose one or several process values ----->

→ **Values to simulate** -----> -----> The previously selected process values are displayed.

→ Choose a process value ----->

→ Enter the value to be simulated -----> -----> The status of the simulation is automatically set to **Running** and the value is being simulated.

→ Check if the device behaves depending on the settings you have made.

The simulation is active as long as the status **Running** is active. Thus, you can:

- leave the menu to check if a measurement view shows the simulated value, or if the analogue output associated to one of the simulated physical quantities gives out the correct current value (see chapter 20.2 [Checking the correct operation of an analogue output](#)).
- or simulate another value for the same process value and/or another process value,
- or simulate one or several events.

→ To stop the simulation, see chapter [17.27.3 Stopping the simulation of process values and events](#).

17.27.2 Checking the behaviour of the device by simulating an event

 The events **Low flow cut off** and **Backward flow** can only be tested by simulating a flow rate value. See chapter [17.27.1](#).

To check the behaviour by simulating one or several events that are enabled on the device, do the following:

→ Go to the **CONFIGURATION** view.

→  **SAW sensor**

→  Confirm to access the **Parameter** view.

→  Go to the **MAINTENANCE** view.



→  **Simulation** -----> 

→  **Status** -----> 

→  **Running** -----> 

→  **Diag. events** -----> 

→  Choose **Process** or **Electronic** or **Sensor** -----> 

→  Choose the events to be simulated -----> 

→ Check if the device behaves depending on the settings you have made.

The simulation is active as long as the status **Running** is active. Thus, you can:

- leave the menu to check if the simulated events have been generated (see chapter [16.8 Reading out the diagnostics events that occurred in the process](#), chapter [16.9 Reading out the diagnostics events that occurred on the electronics](#) and chapter [16.10 Reading out the diagnostics events that occurred on the sensor](#)),
- or simulate one or several events.

→ To stop the simulation, see chapter [17.27.3 Stopping the simulation of process values and events](#).

17.27.3 Stopping the simulation of process values and events

To stop the simulation of process values and events, do the following:

→ Go to the **CONFIGURATION** view.

→  **SAW sensor**

→  Confirm to access the **Parameter** view.

→  Go to the **MAINTENANCE** view.

→  **Simulation** -----> 

→  **Status** -----> 

→  **Stopped** -----> 

 The simulation is stopped.

Menu **Outputs**

18	OUTPUTS – PARAMETER	288
	18.1 Default settings	288
	18.2 Changing the type of output 3.....	288
	18.3 Setting the parameters of an analogue output.....	289
	18.3.1 Changing the process value and the process value range associated to an analogue output.....	289
	18.3.2 Choosing the damping level of the values transmitted on an analogue output ...	290
	18.3.3 Configuring the behaviour of an analogue output depending on the sta- tus of the device	291
	18.4 Disabling an analogue output	292
	18.5 Setting the parameters of a digital output	292
	18.5.1 Configuring a digital output as an on/off output	293
	18.5.2 Configuring a digital output as an output with switching thresholds	294
	18.5.3 Configuring a digital output as a frequency output	295
	18.5.4 Configuring a digital output as a pulse output	296
	18.6 Resetting all the parameters of an output to their default values	298
	18.7 Resetting all the parameters of all the outputs to their default values.....	298
19	OUTPUTS – DIAGNOSTICS	299
	19.1 Analogue output: reading out the current status and the values of the current	299
	19.2 Digital output: reading out the mode, the current status and the current value.....	299
20	OUTPUTS – MAINTENANCE	300
	20.1 Calibrating an analogue output.....	300
	20.2 Checking the correct operation of an analogue output	300
	20.3 Resetting the calibration data of an analogue output to its default values	301
	20.4 Resetting the calibration data of all the analogue outputs to its default values.....	301
	20.5 Checking the correct operation of an on/off output or a threshold output.....	302
	20.6 Checking the correct operation of a frequency output.....	302
	20.7 Checking the correct operation of a pulse output	303

18 OUTPUTS – PARAMETER

 The output parameters can be set with the **Installer** user level.

 Even if the menu Outputs is available on an Ethernet device variant, we recommend to not use the outputs.

18.1 Default settings

You can find the default settings of the device in the CANopen supplement for the Type 8098 FLOWave L at country.burkert.com.

→ Before making any change in the settings, use the Bürkert Communicator software to print a pdf file with all the default settings of the device.

18.2 Changing the type of output 3

NOTICE

Risk of short-circuit if the configuration of output 3 is wrong.

▶ Before wiring the output 3, make sure the output 3 is correctly configured.

By default, the output 3 is configured as an analogue output. It can be configured as a digital output.

To change the type of the output 3, do the following:

→ Go to the **CONFIGURATION** view.

→  **Outputs**

→  Confirm to access the **Parameter** view.

→  **Output 3 type** -----> .

→  Choose the type of the output 3.

→  Save.

 The configuration and the name of the output 3 are changed.

18.3 Setting the parameters of an analogue output

By default, the device has 2 analogue outputs, **Output 1:analog** and **Output 3:analog**. You can change the type of the output 3: see chapter 18.2.

The following parameters can be set:

















- the **process value** associated to the analogue output.
- the value of the process variable, which is associated to the 4 mA current of the analogue output.
- the value of the process variable, which is associated to the 20 mA current of the analogue output.
- the **damping** level of the values that are transmitted on the analogue output. By default, the values transmitted on the analogue output are not damped.
- the behaviour of the analogue output depending on the status of the device.

Table 42: Default parameters of the 2 analogue outputs

Parameter	Default value
Process value associated to the analogue output	Volume flow rate
4 mA value	0.0 l/min
20 mA value	Full scale of the flow rate measurement range. Value depends on the DN of the process connections.
Damping level	None
Behaviour if a Failure message is generated by the device	22mA
Behaviour if an Out of spec. message is generated by the device	Continue
Behaviour if a Maintenance req. message is generated by the device	Continue

18.3.1 Changing the process value and the process value range associated to an analogue output

To change the process value and the process value range associated to an analogue output, do the following:

- Go to the **CONFIGURATION** view.
-  **Outputs**
-  Confirm to access the **Parameter** view.
-  **Output 1: analog** or **Output 3: analog** -----> 
-  **Settings** ----->  -----> The **Current settings** are displayed -----> 
-  Choose a process value -----> 
-   Set the value associated to a 4 mA current -----> 
-   Set the value associated to a 20 mA current ----->  -----> The **New settings** are displayed.
-  Save.

-  The process value and the process value range associated to the analogue output are changed.

18.3.2 Choosing the damping level of the values transmitted on an analogue output

The following diagram shows the effect of the damping on the flow rate measurements.

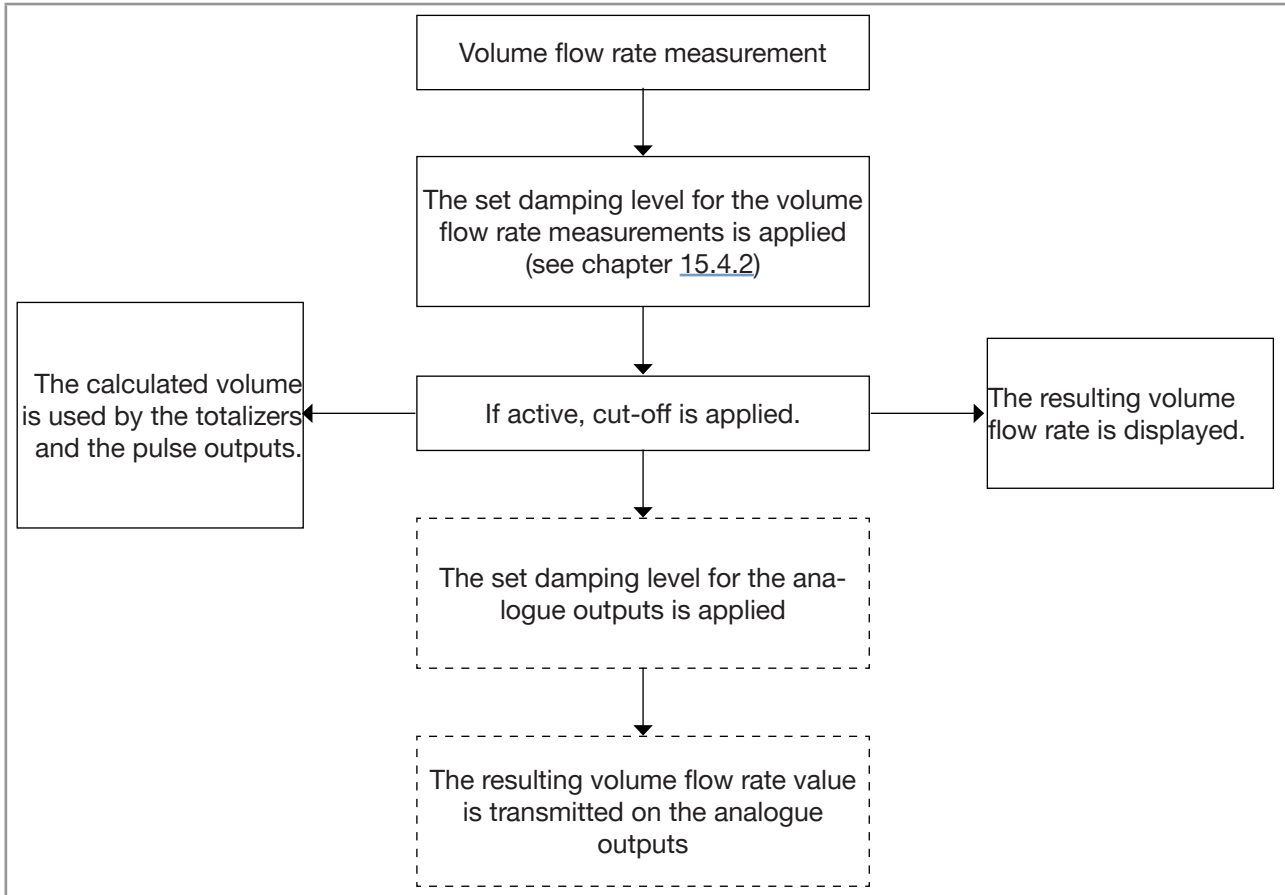

Fig. 67: Effect of the damping on the flow rate measurements

! When the damping is active (i.e. when a **Low**, **Medium** or **High** level has been set) and the values vary for $\pm 30\%$ (for example when charging the pipe or stopping the flow), the damping is not applied to the new measured value.

Table 43: Response times (10 %...90 %) of the damping levels

Damping level	Response time
None	< 1 s
Low	1 s
Medium	10 s
High	30 s

To change the damping level of the values transmitted on an analogue output, do the following:

- Go to the **CONFIGURATION** view.
- **Outputs**
- Confirm to access the **Parameter** view.
- **Output 1: analog** or **Output 3: analog** ----->
- **Damping** ----->
- Choose the damping level.
- Save.
- The damping level is changed.

18.3.3 Configuring the behaviour of an analogue output depending on the status of the device

Depending on the status of the device, the analogue output:

- can continue to transmit the process values.
- or, can transmit and hold the last process value. The choice is not available if measurements are impossible.
- or, can transmit a 22 mA current. The choice is not available if measurements are impossible.
- or, can transmit a 3.6 mA current. The choice is not available if measurements are impossible.
- or, can transmit any preset current value (i.e. a **Forced value**).

To change the behaviour of an analogue output depending on the status of the device, do the following:

- Go to the **CONFIGURATION** view.
- **Outputs**
- Confirm to access the **Parameter** view.
- **Output 1: analog** or **Output 3: analog** ----->
- **Behaviour** ----->
- Choose **Impossible to measure** or **Failure** or **Out of spec.** or **Maintenance req.** -----> ----->
- The current behaviour is displayed ----->
- Choose the behaviour associated to the device status.
- If the behaviour is set to **Forced value**, then set the current value to any value in the range 3.5...23 mA.
- Save.
- The behaviour of an analogue output is changed.

18.4 Disabling an analogue output

If an analogue output is not wired, the analogue output can be disabled to avoid the generation of the events **Output 1, open loop** or **Output 3, open loop**.

To disable an analogue output, do the following:

→ Go to the **CONFIGURATION** view.

→  **Outputs**

→  Confirm to access the **Parameter** view.

→  **Output 1 type** or **Output 3 type** -----> 

→  **Disabled** -----> 

→  Save.

 The analogue output is disabled.

 The menus related to the analogue output are not displayed any more.

18.5 Setting the parameters of a digital output

By default, the device has 1 digital output, **Output 2:digital**, that is configured as a pulse output.

The output 3 can also be configured as a digital output: see chapter [18.2](#).

A digital output can be configured:

- as an on/off output,
- or, to switch depending on two threshold values,
- or, as a frequency output,
- or, as a pulse output.

Table 44: Default parameters of the digital output

Parameter	Default value	DN of process connections
Mode	Pulse	all the diameters
Max. pulse time	65 ms	all the diameters
Max. frequency	2000 Hz	all the diameters
Pulse mode	Pulses/volume	all the diameters

Parameter	Default value	DN of process connections
Pulses/volume	4000 pulses per volume unit	3/8" ASME
	2000 pulses per volume unit	1/2" ASME
		DN08 ISO
	500 pulses per volume unit	ASME 3/4"
		DN15 DIN
	250 pulses per volume unit	DN15 ISO
		ASME 1"
		DN25 DIN
	100 pulses per volume unit	DN25 ISO
		ASME 1 1/2"
		DN40 DIN
		DN40 ISO
	60 pulses per volume unit	ASME 2"
SMS 50		
DN50 DIN		
DN50 ISO		
40 pulses per volume unit	ASME 2 1/2"	
	DN65 DIN	
	DN65 ISO	
30 pulses per volume unit	ASME 3"	
	DN80 DIN	
Inverted	No	DN80 ISO
		all the diameters

18.5.1 Configuring a digital output as an on/off output

An on/off output switches every time the associated event is generated.

You can choose between the following events:

- **Failure**
- **Function check**
- **Out of spec.**
- **Maintenance req.**
- any event activated in the menu **SAW sensor – Parameter – Diagnostics – Process**
- any event activated in the menu **SAW sensor – Parameter – Diagnostics – Electronic**

To configure a digital output as an on/off output, do the following:

→ Go to the **CONFIGURATION** view.

→ **Outputs**

→ Confirm to access the **Parameter** view.

→ **Output 2:digital** or **Output 3:digital** ----->

→ **Mode** ----->

- On/off ----->
- Settings -----> -----> The **Current settings** are displayed ----->
- Choose the events ----->
- Choose to invert the switching or not (see Fig. 68 and Fig. 69) ----->
- Set the value of the switching time delay -----> -----> The **New settings** are displayed.
- Save.

The digital output is configured as an on/off output.

18.5.2 Configuring a digital output as an output with switching thresholds

An output with switching thresholds switches depending on two threshold process values. The output can switch either according to an hysteresis model or according to a window model.

Hysteresis switching

The output status changes when a threshold is reached:

- by increasing values, the output state changes when the high threshold X_+ is reached.
- by decreasing values, the output state changes when the low threshold X_- is reached.

X_- = low switching threshold
 X_+ = high switching threshold

Fig. 68: Hysteresis switching

Window switching: the output state changes as soon as any threshold (X_- or X_+) is reached.

X_- = low switching threshold
 X_+ = high switching threshold

Fig. 69: Window switching

To configure a digital output as an output with switching thresholds, do the following:

→ Go to the **CONFIGURATION** view.

→ **Outputs**

→ Confirm to access the **Parameter** view.

→ **Output 2:digital** or **Output 3:digital** ----->

→ **Mode** ----->

→ **Threshold** ----->

→ **Settings** -----> -----> The **Current settings** are displayed ----->

→ Choose the process value associated to the digital output ----->

→ Choose the hysteresis switching or the window switching of the digital output ----->

If the high threshold is equal to the low threshold, the digital output is deactivated.

→ Set the value of the high threshold ----->

→ Set the value of the low threshold ----->

→ Choose to invert the switching or not ----->

→ Set the value of the switching time delay -----> -----> The **New settings** are displayed.

→ Save.

The digital output is configured to switch depending on 2 threshold values.

18.5.3 Configuring a digital output as a frequency output

A frequency output transmits a frequency signal which is proportional to the chosen process value.

To configure a digital output as a frequency output, do the following:

→ Go to the **CONFIGURATION** view.

→ **Outputs**

→ Confirm to access the **Parameter** view.

→ **Output 2:digital** or **Output 3:digital** ----->

→ **Mode** ----->

→ **Frequency** ----->



→ **Settings** -----> -----> The **Current settings** are displayed ----->



MAN 1000273158 EN Version: M Status: RL (released | freigegeben) printed: 22.06.2022



→  Choose the process value associated to the digital output -----> 





If the high value is equal to the low value, the digital output is deactivated.

→   Set the high value of the frequency range -----> 

→   Set the process value which is associated to the high value of the frequency range -----> 

→   Set the low value of the frequency range -----> 

→   Set the process value which is associated to the low value of the frequency range -----> 

-----> The **New settings** are displayed.

→  Save.

 The digital output is configured as a frequency output.

18.5.4 Configuring a digital output as a pulse output

When the digital output is configured as a pulse output, it transmits:

- either a number of pulses proportional to the measured volume (**pulse/volume**),
- or 1 pulse each time a set volume of liquid has been measured by the device (**volume/pulse**),
- or a number of pulses proportional to the measured mass (**pulse/mass**),
- or 1 pulse each time a set mass of liquid has been measured by the device (**mass/pulse**).



By default, the value of the parameter **pulse/volume** is set for the full scale of the flow-rate measurement range. Observe the following rules to adapt the value of the parameter **pulse/volume** to your flow-rate measurement range:

- Make sure that the maximum flow rate value (in litres per second) multiplied by the pulse per litre value is lower than 2000 pulses per second. Pulses above the 2000 pulses/s limit are not transmitted immediately but are accumulated. The accumulated pulses are transmitted as a block when the 2000 pulses/s limit is no longer exceeded.
- The pulse output of the device is connected to an input of another equipment, for example a PLC. Take into account the frequency of the input, because it can be lower than the maximum pulse frequency that you have set.



Calculation example for the number of pulses per volume:

Consider a device with DN40 ISO process connections. The following device data are needed:

- maximum measurable flow-rate at a liquid velocity of 10 m/s:
925 L/min

→ Read the maximum flow-rate value in **Outputs** -----> **Parameter** -----> **Output 1: analog** or **Output 3: analog** -----> **Settings** -----> **Current settings** -----> **20 mA value** or on the test report that is delivered with the device.

- default number of pulses per volume unit:
100 pulses/volume unit

Data for your application with a maximum measurable flow-rate of 400 L/min = 6.6 L/s

- number of pulses per volume unit with a safety margin of 5 %, in order to not exceed 2000 Hz:
(2000 – 5 % x 2000) / 6.6 L/s = 287 pulses/litre

To configure a digital output as a pulse output, do the following:

→ Go to the **CONFIGURATION** view.

→  **Outputs**

→  Confirm to access the **Parameter** view.

→  **Output 2:digital** or **Output 3:digital** -----> 

→  **Mode** -----> 

→  **Pulse** -----> 

→  **Settings** ----->  -----> The **Current settings** are displayed -----> 



→  **Enabled** -----> 



→   Set the value of the maximum duration of a pulse -----> 



→   Set the value of the maximum frequency for the transmission of the pulses -----> 



→  Choose **pulse/volume** or **volume/pulse** in the wanted volume units -----> 
or



→  Choose **pulse/mass** or **mass/pulse** in the wanted mass units -----> 

→   If you have chosen **pulse/volume**, set the number of pulses to be transmitted on the digital output for either 1 litre or 1 US gallon or 1 imperial gallon. Enter a number of pulses that is higher than 1. If you enter a number of pulses that is lower than 1, the display resolution is not optimum. -----> 

→   If you have chosen **volume/pulse**, set the volume of liquid for which 1 pulse is transmitted on the digital output -----> 

→   If you have chosen **pulse/mass**, set the number of pulses to be transmitted on the digital output for either 1 g, 1 kg, 1 lb or 1 t. Enter a number of pulses that is higher than 1. If you enter a number of pulses that is lower than 1, the display resolution is not optimum. -----> 

→   If you have chosen **mass/pulse**, set the mass of liquid for which 1 pulse is transmitted on the digital output -----> 

→  Choose to invert the signal or not -----> 

→  Choose the counting direction ----->  -----> The **New settings** are displayed.

→  Save.

 The digital output is configured as a pulse output.



18.6 Resetting all the parameters of an output to their default values

To reset all the parameters of an output to their default values, do the following:

→ Go to the **CONFIGURATION** view.

→  **Outputs**

→  Confirm to access the **Parameter** view.

→  Choose an output -----> 

→  **Reset to default** -----> 

→  To reset the parameters of the selected output -----> All the parameters of the output are reset.

→  To acknowledge the displayed message.

18.7 Resetting all the parameters of all the outputs to their default values

To reset all the parameters of all the outputs to their default values, do the following:

→ Go to the **CONFIGURATION** view.

→  **Outputs**

→  Confirm to access the **Parameter** view.

→  **Reset to default** -----> 

→  To reset the parameters of all the outputs -----> The parameters of all the outputs are reset.

→  To acknowledge the displayed message.

19 OUTPUTS – DIAGNOSTICS

19.1 Analogue output: reading out the current status and the values of the current

Any user can read out the following data related to an analogue output:

- the current status of the analogue output, i.e. **OK**, **Open loop** or **Impedance too high**.
- the value of the current related to the measured quantity of the process value,
- the value of the current transmitted on the analogue output.

This data is in read-only mode. To read out some data related to an analogue output, do the following:

→ Go to the **CONFIGURATION** view.

→  **Outputs**

→  Confirm to access the **Parameter** view.

→  Go to the **DIAGNOSTICS** view.

→  Choose the analogue output -----> 

→ Read out the data related to the analogue output.

→  To go back to the parent menu.

19.2 Digital output: reading out the mode, the current status and the current value

Any user can read out the following data related to a digital output:

- the current mode, e.g. **pulse**, of the digital output,
- the current status of the digital output, i.e. **OK** or **Overload**.
- the current value of the digital output, e.g. for a pulse output, the number of pulses transmitted on the output.

This data is in read-only mode. To read out some data related to a digital output, do the following:

→ Go to the **CONFIGURATION** view.

→  **Outputs**

→  Confirm to access the **Parameter** view.

→  Go to the **DIAGNOSTICS** view.

→  Choose the digital output -----> 

→ Read out the data related to the digital output.

→  To go back to the parent menu.

















20 OUTPUTS – MAINTENANCE

 The settings can be made with the **Installer** user level.

20.1 Calibrating an analogue output





The analogue outputs are calibrated at the factory.

To adjust the analogue output to your equipment, do the following:

- Connect a multimeter to the analogue output you want to adjust.
- Go to the **CONFIGURATION** view.
-  **Outputs**
-  Confirm to access the **Parameter** view.
-  Go to the **MAINTENANCE** view.
-  **Output 1: analog** or **Output 3: analog** -----> 
-  **Calibration** ----->  -----> The **Current settings** are displayed ----->  -----> The device generates a 4 mA current on the chosen analogue output.
-   Enter the current value measured by the multimeter ----->  -----> The device generates a 20 mA current on the chosen analogue output.
-   Enter the current value measured by the multimeter ----->  -----> The **New settings** are displayed.
-  Save.
-  The analogue output is adjusted.

20.2 Checking the correct operation of an analogue output

To check the correct operation of an analogue output, do the following:

- Connect a multimeter to the analogue output you have adjusted.
- Go to the **CONFIGURATION** view.
-  **Outputs**
-  Confirm to access the **Parameter** view.
-  Go to the **MAINTENANCE** view.
-  **Output 1: analog** or **Output 3: analog** -----> 



→ Enter the current value to be tested ----->  -----> The device generates the entered current value on the chosen analogue output.

→  To test another value or  To quit the test.

20.3 Resetting the calibration data of an analogue output to its default values

To reset the calibration data of an analogue output to its default values, do the following:

→ Go to the **CONFIGURATION** view.

→  **Outputs**

→  Confirm to access the **Parameter** view.

→  Go to the **MAINTENANCE** view.

→  **Output 1: analog** or **Output 3: analog** -----> 

→  **Reset to default** -----> 

→  To reset the calibration data of an analogue output to its default values.

→  The calibration data of an analogue output is reset to its default values.

→  To acknowledge the displayed message.

20.4 Resetting the calibration data of all the analogue outputs to its default values

To reset the calibration data of all the analogue outputs to its default values, do the following:

→ Go to the **CONFIGURATION** view.

→  **Outputs**

→  Confirm to access the **Parameter** view.

→  Go to the **MAINTENANCE** view.

→  **Reset to default** -----> 













→  To reset the calibration data of all the analogue outputs to its default values.

→  The calibration data of all the analogue outputs is reset to its default values.

→  To acknowledge the displayed message.













20.5 Checking the correct operation of an on/off output or a threshold output

To check the correct operation of a digital output configured as an on/off output, do the following:

- Connect a multimeter to the digital output configured as an on/off output.
- Energize the output.
- Go to the **CONFIGURATION** view.
-  **Outputs**
-  Confirm to access the **Parameter** view.
-  Go to the **MAINTENANCE** view.
-  **Output 2: digital** or **Output 3: digital**, configured as an on/off output or as a threshold output -----> 
-  **Test** ----->  -----> 
-  **On** or **Off** ----->  -----> Check if the output is operating correctly.
-  To test another state or  To quit the test.













20.6 Checking the correct operation of a frequency output

To check the correct operation of a digital output configured as a frequency output, do the following:

- Connect a frequency meter to the digital output configured as a frequency output.
- Energize the output.
- Go to the **CONFIGURATION** view.
-  **Outputs**
-  Confirm to access the **Parameter** view.
-  Go to the **MAINTENANCE** view.
-  **Output 2: digital** or **Output 3: digital**, configured as a frequency output -----> 
-  **Test** ----->  -----> 
-  Enter a frequency value ----->  -----> Check if the output is operating correctly.
-  To test another value or  To quit the test.

20.7 Checking the correct operation of a pulse output

To check the correct operation of a digital output configured as a pulse output, do the following:

- Connect a counter to the digital output configured as a pulse output.
- Energize the output.
- Go to the **CONFIGURATION** view.
-  **Outputs**
-  Confirm to access the **Parameter** view.
-  Go to the **MAINTENANCE** view.
-  **Output 2: digital** or **Output 3: digital**, configured as a pulse output -----> 
-  **Test** -----> 
-  Enter a frequency value -----> 
-  Enter a number of pulses ----->  -----> Check if the output is operating correctly. For example through the correct flashing of the related LED on the transmitter board.
-  To test another number of pulses or  To stop the test and go back to the parent menu.

Menu **Industrial Communication**

21	MENU PARAMETER	306
21.1	Default settings and information on configuration files	306
21.2	Industrial Protocol settings.....	306
21.2.1	Choosing the communication protocol	306
21.2.2	Reading out the MAC address of the device	306
21.2.3	Changing the static IP address.....	307
21.2.4	Changing the network mask	307
21.2.5	Changing the address of the default gateway	308
21.2.6	Reading out the IP address assigned by a DHCP	308
21.2.7	Choosing the internal cycle time	308
21.2.8	Choosing the communication timeout and enabling it.....	309
21.2.9	Disabling the communication timeout.....	309
22	MENU MAINTENANCE	310
22.1	Reading out the software version number.....	310
22.2	Reading out the hardware version number	310
22.3	Reading out the article number of the device	310
22.4	Reading out the article number of the software.....	311
22.5	Reading out the serial number of the device.....	311
22.6	Reading out stack information	311
22.7	Reading out the version of the industrial communication	312
22.8	Restarting the current industrial communication	312
22.9	Resetting the industrial communication module.....	313
22.10	Restoring the configuration file	313
23	MENU DIAGNOSTICS	314
23.1	Reading out the active protocol and the internal cycle time	314
23.2	Reading out the number of Ethernet connections	314
23.3	Reading out the internal temperature of the industrial communication module	315
23.4	Reading out the last status code	315

21 MENU PARAMETER



The Industrial communication parameters can be set with the **Installer** user level.

The section describes the menus related to the industrial communication module which is fitted on the device.

21.1 Default settings and information on configuration files

You can find the default settings of the device and information on the configuration files in the Ethernet industrial communication supplement for the Type 8098 FLOWave L at country.burkert.com.

→ Before making any change in the settings, use the Bürkert Communicator software to print a pdf file with all the default settings of the device.

21.2 Industrial Protocol settings

21.2.1 Choosing the communication protocol

Do the following:

→ Go to the **CONFIGURATION** view.

→  **Industrial communication**

→  Confirm to access the **Parameter** view.

→  **Protocol settings** -----> 

→  **Protocol** -----> 

→  Choose the communication protocol.

→  Save.







 The gateway address is changed.

21.2.2 Reading out the MAC address of the device

You can read out the MAC address of the device. But be aware that the device uses 3 MAC addresses:









- 1 for the device (which is marked on a specific label and which can be read out in the configuration menu),
- 1 for port X1 of the Industrial communication gateway (MAC address of the device plus 1),
- 1 for port X2 of the Industrial communication gateway (MAC address of the device plus 2).

Do the following:

- Go to the **CONFIGURATION** view.
-  **Industrial communication**
-  Confirm to access the **Parameter** view.
-  **IP settings** ----->  ----->  **MAC address** -----> 
-  Go back to the parent menu.









21.2.3 Changing the static IP address

Do the following:

- Go to the **CONFIGURATION** view.
-  **Industrial communication**
-  Confirm to access the **Parameter** view.
-  **IP settings** -----> 
-  **Static IP address** ----->  The current address is displayed.
-   Set the new address.
-  Save.
- ✔ The static address is changed.

21.2.4 Changing the network mask











Do the following:

- Go to the **CONFIGURATION** view.
-  **Industrial communication**
-  Confirm to access the **Parameter** view.
-  **IP settings** -----> 
-  **Network mask** ----->  The current network mask is displayed.
-   Set the new network mask.
-  Save.
- ✔ The network mask is changed.

21.2.5 Changing the address of the default gateway

Before commissioning the device, you must change the address of the gateway.









Do the following:

- Go to the **CONFIGURATION** view.
-  **Industrial communication**
-  Confirm to access the **Parameter** view.
-  **IP settings** -----> 
-  **Default gateway** ----->  The current gateway address is displayed.
-   Set the new address of the gateway.
-  Save.
-  The address of the gateway is changed.

21.2.6 Reading out the IP address assigned by a DHCP

When the device is connected to a network that uses DHCP mode, a temporary IP address is automatically assigned to the device. You can read out this address.





Do the following:

- Go to the **CONFIGURATION** view.
-  **Industrial communication**
-  Confirm to access the **Parameter** view.
-  **IP settings** ----->  ----->  **Temp. IP address** -----> 
-  Go back to the parent menu.
-  If the device is removed from the network and again connected to this network, another temporary IP address is assigned to the device.

21.2.7 Choosing the internal cycle time

The internal cycle time is the refresh time of the data in the industrial communication module.

Do the following:

- Go to the **CONFIGURATION** view.
-  **Industrial communication**
-  Confirm to access the **Parameter** view.
-  **Advanced settings** -----> 

→  **Internal cycle time** -----> 

→  Choose the value. You can choose between **Auto cycle time** and several values in milliseconds.

→  Save.

 The internal cycle time is set.

21.2.8 Choosing the communication timeout and enabling it

The feature is only available for the protocol Modbus TCP. If a Modbus TCP communication is stopped because an Ethernet cable is disconnected, the disconnection will be recognized after the set timeout.

The timeout has no effect if the network master stops the communication.

Do the following:

→ Go to the **CONFIGURATION** view.

→  **Industrial communication**

→  Confirm to access the **Parameter** view.

→  **Advanced settings** -----> 

→  **Communication Timeout** -----> 

→  Choose the value. You can choose between **Auto cycle time** and several values in milliseconds.

→  Save.

→ Restart the device.

 The communication timeout is set and enabled.

21.2.9 Disabling the communication timeout

Do the following:

→ Go to the **CONFIGURATION** view.

→  **Industrial communication**

→  Confirm to access the **Parameter** view.

→  **Advanced settings** -----> 

→  **Communication Timeout** -----> 

→  **Disabled**









→  Save.

 The timeout is disabled.

22 MENU MAINTENANCE









22.1 Reading out the software version number

Do the following:

- Go to the **CONFIGURATION** view.
-  **Industrial communication**
-  Confirm to access the **Parameter** view.
-  Go to the **MAINTENANCE** view.
-  **Version numbers** -----> 
-  **Software version** -----> 
-  Go back to the parent menu.









22.2 Reading out the hardware version number

Do the following:

- Go to the **CONFIGURATION** view.
-  **Industrial communication**
-  Confirm to access the **Parameter** view.
-  Go to the **MAINTENANCE** view.
-  **Version numbers** -----> 
-  **Hardware version** -----> 
-  Go back to the parent menu.









22.3 Reading out the article number of the device

Do the following:

- Go to the **CONFIGURATION** view.
-  **Industrial communication**
-  Confirm to access the **Parameter** view.
-  Go to the **MAINTENANCE** view.
-  **Version numbers** -----> 
-  **Ident. number** -----> 
-  Go back to the parent menu.









22.4 Reading out the article number of the software

Do the following:

- Go to the **CONFIGURATION** view.
-  **Industrial communication**
-  Confirm to access the **Parameter** view.
-  Go to the **MAINTENANCE** view.
-  **Version numbers** -----> 
-  **Software ident. number** -----> 
-  Go back to the parent menu.









22.5 Reading out the serial number of the device

Do the following:

- Go to the **CONFIGURATION** view.
-  **Industrial communication**
-  Confirm to access the **Parameter** view.
-  Go to the **MAINTENANCE** view.
-  **Version numbers** -----> 
-  **Serial number** -----> 
-  Go back to the parent menu.









22.6 Reading out stack information

Do the following:

- Go to the **CONFIGURATION** view.
-  **Industrial communication**
-  Confirm to access the **Parameter** view.
-  Go to the **MAINTENANCE** view.
-  **Version numbers** -----> 
-  **Stack name** or **Stack version** or **Stack Build** or **Stack Revision** or **Stack Date** -----> 
-  Go back to the parent menu.

22.7 Reading out the version of the industrial communication











Do the following:

- Go to the **CONFIGURATION** view.
-  **Industrial communication**
-  Confirm to access the **Parameter** view.
-  Go to the **MAINTENANCE** view.
-  **Version numbers** ----->  ----->  **Com Version** -----> 
-  Go back to the parent menu.

22.8 Restarting the current industrial communication

You can restart the current industrial communication between the device and the other network participants. During the restart, the communication between ports X1 and X2 is still possible.

Do the following:

- Go to the **CONFIGURATION** view.
-  **Industrial communication**
-  Confirm to access the **Parameter** view.
-  Go to the **MAINTENANCE** view.
-  **Reset device** ----->  ----->  **Restart** -----> 
-  If you do not want to restart the current industrial communication but go back to the parent menu.
-  To restart the current industrial communication.
-  The current industrial communication has been restarted.

22.9 Resetting the industrial communication module

You can reset the industrial communication module without switching off the power supply. During the reset, the communication between ports X1 and X2 is not possible.

Do the following:

→ Go to the **CONFIGURATION** view.

→  **Industrial communication**

→  Confirm to access the **Parameter** view.

→  Go to the **MAINTENANCE** view.

→  **Reset device** -----> 

→  **Hardware reset of industrial communication** -----> 

→  If you do not want to reset the industrial communication module but go back to the parent menu.

→  To reset the industrial communication module. The device will restart.

 The industrial communication module has been reset. The communication between ports X1 and X2 is possible.

22.10 Restoring the configuration file

You can restore the configuration file with the PDO mapping from the device to the industrial communication module.

Do the following:

→ Go to the **CONFIGURATION** view.

→  **Industrial communication**

→  Confirm to access the **Parameter** view.

→  Go to the **MAINTENANCE** view.

→  **Reset device** -----> 

→  **Restore XML data** -----> 

→  If you do not want to restore the configuration file but go back to the parent menu.







→  To restore the configuration file. The device will restart.

 The configuration file has been restored.

23 MENU DIAGNOSTICS

23.1 Reading out the active protocol and the internal cycle time









Do the following:

- Go to the **CONFIGURATION** view.
-  **Industrial communication**
-  Confirm to access the **Parameter** view.
-  Go to the **DIAGNOSTICS** view.
-  **Protocol overview** -----> 
-  Go back to the parent menu.

23.2 Reading out the number of Ethernet connections









You can read out the number of Ethernet connections that have been established between the device and its clients. If the device has been disconnected from all its clients, the counter increments at the first Ethernet connection that is established with the device.

Do the following:

- Go to the **CONFIGURATION** view.
-  **Industrial communication**
-  Confirm to access the **Parameter** view.
-  Go to the **DIAGNOSTICS** view.
-  **Advanced** -----> 
-  **Connections to PLC** -----> 
-  Go back to the parent menu.









23.3 Reading out the internal temperature of the industrial communication module

Do the following:

- Go to the **CONFIGURATION** view.
-  **Industrial communication**
-  Confirm to access the **Parameter** view.
-  Go to the **DIAGNOSTICS** view.
-  **Advanced** -----> 
-  **Device temperature** -----> 
-  Go back to the parent menu.

23.4 Reading out the last status code

Do the following:

- Go to the **CONFIGURATION** view.
-  **Industrial communication**
-  Confirm to access the **Parameter** view.
-  Go to the **DIAGNOSTICS** view.
-  **Advanced** -----> 
-  **Last status code** -----> 
-  Go back to the parent menu.

Troubleshooting, maintenance, transport, storage

- 24 MAINTENANCE AND TROUBLESHOOTING320
 - 24.1 Safety instructions320
 - 24.2 Information on returning the device to the manufacturer or to the reseller321
 - 24.3 Cleaning the outer surface of the device.....321
 - 24.4 Cleaning In Place (CIP) of the device.....321
 - 24.5 Sterilisation In Place (SIP) of the device322
 - 24.6 Troubleshooting when no message is displayed323
 - 24.7 Troubleshooting when a message is displayed.....323
 - 24.8 Messages when setting wrong parameters.....324
 - 24.8.1 Kinematic viscosity ≤ 0 . Check the flow viscosity compensation's parameters ..324
 - 24.9 Messages due to device internal diagnostics324
 - 24.9.1 Message "Overvoltage detected"324
 - 24.9.2 Message "Undervoltage detected"325
 - 24.9.3 Message "Voltage is above the warning limit"325
 - 24.9.4 Message "Voltage is below the warning limit"325
 - 24.9.5 Message "Battery voltage is below the warning limit"326
 - 24.9.6 Message "bÜS event: bus connection lost / not available"326
 - 24.9.7 Message "Overtemperature detected"326
 - 24.9.8 Message "Undertemperature detected"327
 - 24.9.9 Message "Temperature is above the warning limit"327
 - 24.9.10 Message "Temperature is below the warning limit"327
 - 24.9.11 Message "Internal message store overflow"328
 - 24.9.12 Message "No signals from interdigital transducer"328
 - 24.9.13 Message "No temperature sensor detected"328
 - 24.9.14 Message "Pipe characteristics have changed: check limits values"328
 - 24.9.15 Message "Measure board is in boot starter mode, no firmware found n°1"329
 - 24.9.16 Message "Measured values cannot be used"329
 - 24.9.17 Message "Communication between transmitter PCB and measurement PCB has been interrupted n°x"329
 - 24.9.18 Message "The measurement board bootloader operation failed n° 1"329
 - 24.9.19 Message "An error occurred during communication"330
 - 24.9.20 Message "Max. flow rate"330

MAN 1000273158 EN Version: M Status: RL (released | freigegeben) printed: 22.06.2022

24.9.21	Message "Max temperature"	330
24.9.22	Message "Totalizer 1 stopped" / "Totalizer 2 stopped" or "Mass totalizer 1 stopped" / "Mass totalizer 2 stopped"	330
24.9.23	Message "Totalizer 1 started" / "Totalizer 2 started" or "Mass totalizer 1 started" / "Mass totalizer 2 started"	331
24.10	Messages due to calibration or simulation.....	331
24.10.1	Message "Calibration result out of range"	331
24.10.2	Message "Zero calibration cancelled, the flow rate is higher than 5 % of full scale"	331
24.10.3	Message "Calibration cancelled"	332
24.10.4	Message "Calibration cancelled, the flow rate is less than 5 % of the full scale"	332
24.10.5	Message "Resulting K factor is less than 0.8 or higher than 1.2"	332
24.10.6	Message "Resulting offset is higher than 10 °C, 18 °F"	332
24.10.7	Message "Test mode activated"	333
24.10.8	Message "Simulation mode active"	333
24.11	Messages due to the monitoring of process values	333
24.11.1	Message "Flow rate too high"	333
24.11.2	Message "Flow rate too low"	334
24.11.3	Message "Temperature too high"	334
24.11.4	Message "Temperature too low"	335
24.11.5	Message "Value totalizer 1 too high" / "Value totalizer 2 too high" or "Value mass totalizer 1 too high" / "Value mass totalizer 2 too high"	335
24.11.6	Message "Value totalizer 1 too low" / "Value totalizer 2 too low" or "Value mass totalizer 1 too low" / "Value mass totalizer 2 too low"	336
24.11.7	Message "Fluid velocity too high"	336
24.11.8	Message "Fluid velocity too low"	337
24.11.9	Message "DF too high"	337
24.11.10	Message "DF too low"	338
24.11.11	Message "Acoustic transmission factor too high"	338
24.11.12	Message "Acoustic transmission factor too low"	339
24.11.13	Message "Density too high"	339
24.11.14	Message "Density too low"	340
24.11.15	Message "Concentration 1 too high" / "Concentration 2 too high"	340
24.11.16	Message "Concentration 1 too low" / "Concentration 2 too low"	341

24.12	Messages due to diagnostics events	341
24.12.1	Message "Diagnostic is active"	341
24.12.2	Message "Diagnostic is inactive"	341
24.12.3	Message "Not totally filled"	342
24.12.4	Message "Liquid out of range"	342
24.12.5	Message "Unstable flow rate"	342
24.12.6	Message "Low flow cut off"	343
24.12.7	Message "Change of liquid"	343
24.12.8	Message "Backward flow"	343
24.12.9	Message "Sound conductivity out of range"	344
24.12.10	Message "AO1 open loop" or "AO3 open loop"	344
24.12.11	Message "AO1 Diag error" or "AO3 Diag error"	344
24.12.12	Message "DO2 overload" or "DO3 overload"	345
24.13	Messages due to the industrial communication module	345
24.13.1	Message "No proper connection to the process control system"	345
24.13.2	Message "Cyclic data transfer has been slower than configured timeout"	346
24.13.3	Message "No or incorrect mapping file available"	346
24.13.4	Message "Please select a protocol and restart the device"	346
24.13.5	Message "Master tried to plug wrong module or submodule"	346
24.13.6	Message "Initialization of industrial communication"	347
24.13.7	Message "Fieldbus master is running in stop mode"	347
25	SPARE PARTS AND ACCESSORIES	348
26	PACKAGING, TRANSPORT	349
27	STORAGE	349
28	DISPOSAL OF THE DEVICE	349

MAN 1000273158 EN Version: M Status: RL (released | freigegeben) printed: 22.06.2022

24 MAINTENANCE AND TROUBLESHOOTING

24.1 Safety instructions



Risk of injury due to electrical voltage.

- ▶ Before carrying out work on the system, disconnect the electrical power for all the conductors and isolate it.
- ▶ In accordance with standard UL/EN 61010-1, all equipment connected to the Type 8098 FLOWave L flowmeter shall be double insulated with respect to the mains and all circuits connected to the Type 8098 FLOWave L flowmeter must be limited energy circuits.
- ▶ Observe all applicable accident protection and safety regulations for electrical equipment.

Risk of injury due to pressure in the installation.

- ▶ Before any intervention in the installation, stop the circulation of liquid, cut off the pressure and drain the pipe.
- ▶ Before any intervention in the installation, make sure there is no pressure in the pipe.

If switched on for a prolonged time, risk of burns or fire due to hot device surfaces

- ▶ Do not touch with bare hands.
- ▶ Keep the device away from highly flammable substances and liquids.

Risk of burns due to high liquid temperatures.

- ▶ Do not touch with bare hands the parts of the device that are in contact with the liquid.
- ▶ Use safety gloves to handle the device.
- ▶ Before opening the pipe, stop the circulation of liquid and drain the pipe.
- ▶ Before opening the pipe, make sure the pipe is completely empty.

Risk of injury due to the nature of the liquid.

- ▶ Respect the prevailing regulations on accident prevention and safety relating to the use of dangerous liquids.



WARNING

Risk of injury due to non-conforming maintenance.

- ▶ Maintenance must only be carried out by qualified and skilled staff with the appropriate tools.
- ▶ Ensure that the restart of the installation is controlled after any interventions.



CAUTION

Risk of injury due to a heavy device.

A heavy device can fall down during transport or during installation and cause injuries.

- ▶ Transport, install and dismantle a heavy device with the help of another person.
- ▶ Use appropriate tools.

24.2 Information on returning the device to the manufacturer or to the reseller

- To return the device for calibration or any after sales service, use the original packaging.
- Send the device back to your local Bürkert sales office. The addresses of our international sales offices are available on the internet at country.burkert.com.

24.3 Cleaning the outer surface of the device



- Always use a cleaning agent compatible with the materials from which the device is made.
- Pay special attention to the cable glands which are made of nickel plated brass.

The outer surface device can be cleaned with a cloth slightly dampened water or with a detergent compatible with the materials the device is made of.

Please feel free to contact your Bürkert supplier for any additional information.

24.4 Cleaning In Place (CIP) of the device

The measurement tube of the device can be cleaned in place in all the applications the device is used in.

- Do the cleaning in place procedure at appropriate intervals to prevent malfunctions or contamination.

NOTICE

The device and the seals used on the process connections can be damaged by the cleaning agents or the disinfecting agents.

- ▶ Use cleaning agents or disinfecting agents with a concentration that is compatible with the material the measurement tube is made of.
- ▶ Check the chemical compatibility of the cleaning agents or disinfecting agents with the materials of the seals used on the process connections.
- ▶ For more information on the chemical compatibility and the cleaning temperatures contact your local Bürkert sales office.
- ▶ Obey the cleaning in place procedure that is suited for your application.

Procedure for the cleaning in place of the device:

- Rinse the measurement tube with water of the best quality available in the factory (ideally, water for injection or purified water) under the following conditions:
 - at a temperature between 50 °C and 75 °C,
 - at a flow velocity between 1.5 m/s and 2.1 m/s,
 - for a duration that is determined by your CIP recipe.
- Prepare one or two cleaning agents at concentrations and with chemical properties that have proven their effectiveness on the residues to be removed. Make sure the concentration of the cleaning agent does not damage stainless steel 316L.
- Let the cleaning agent circulate through the measurement tube under the following conditions:
 - at a temperature between 50 °C and 75 °C,
 - at a flow velocity between 1.5 m/s and 2.1 m/s,
 - for a duration that is determined by your CIP recipe.

- Rinse the measurement tube with water of the best quality available in the factory (ideally, water for injection or purified water) under the same conditions as the first rinse.
- If needed, let a second cleaning agent circulate through the measurement tube, under the same conditions as the first cleaning agent, to neutralize any alkaline residues that remain.
- Do a final rinse of the measurement tube, under the same conditions as the first two rinses. Monitor the conductivity value of the final rinse to make sure all the cleaning agents have been removed.
- Blow air through the measurement tube to remove moisture and to ensure maintenance of a good passive layer.
- If needed, do a de-scaling by letting a solution made of water, nitric acid HNO_3 [15 %...20 %] and hydrofluoric acid HF [2 %...5 %] at a temperature between 20 °C and 60 °C circulate through the measurement tube for 5...30 minutes.
- After a de-scaling, or to prevent any corrosion effects after 1 or more (depending on the application) CIP-procedures, do a passivation by letting a solution made of water and nitric acid HNO_3 [3 %...5 %] at a temperature between 70 °C and 80 °C circulate through the measurement tube for the same duration as the CIP-procedure. Then, rinse the measurement tube with water with the best quality available in the factory (ideally, water for injection or purified water) under the same conditions as the other rinses.
- Blow air through the measurement tube to remove moisture and to ensure creation of a uniform passive layer.

24.5 Sterilisation In Place (SIP) of the device

The measurement tube of the device can be sterilised in place in all the applications the device is used in.

- Do the sterilisation in place procedure using dry saturated steam at a temperature between 121 °C and 140 °C for max. 1 hour.

24.6 Troubleshooting when no message is displayed

Problem	The display is OFF
Possible cause	The device is not energized
What to do?	<ol style="list-style-type: none"> 1. Check the wiring. 2. Make sure that the voltage supply at the device terminals is 12...35 V DC. The actual value can be read in chapter 13.2.4. 3. Check that the power supply source is working properly.





24.7 Troubleshooting when a message is displayed

→ If the message displayed on your device is not explained in the Operating Instructions, contact Bürkert.

If a message has been generated:

- a symbol is displayed in the information bar: see [Table 45](#).
- Ex works and if the device status indicator is not switched off (see chapter [12.4.2 Switching off the device status indicator](#)"), the device status indicator changes its colour and state based on the NAMUR NE 107 recommendation: see chapter [5.8](#).
- The message is displayed in a list called **Messages overview**. The list can be accessed via the context menu. See chapter [10.7.3 Reading out the messages generated by the device](#).

Table 45: Device status symbols

Symbol	Status	Description
	Failure, error or fault	<ul style="list-style-type: none"> • Malfunction, • or monitored values in the error range.
	Function check	Ongoing work on the device (for example, checking the correct behaviour of the outputs by simulating measurement values); the output signal is temporarily invalid (e.g. frozen).
	Out of specification	<p>The ambient conditions or process conditions for the device are outside the permitted ranges.</p> <p>Device internal diagnostics point to problems in the device or with the process properties.</p>
	Maintenance required	<p>The device is in controlled operation; however, the function is briefly restricted.</p> <p>→ Do the required maintenance operation.</p>

24.8 Messages when setting wrong parameters

24.8.1 Kinematic viscosity ≤ 0 . Check the flow viscosity compensation's parameters

Message	Kinematic viscosity ≤ 0 . Check the flow viscosity compensation's parameters
Symbol displayed in the information bar	
Possible cause	<ul style="list-style-type: none"> • When activating the compensation for a liquid with a constant viscosity, you have entered a negative value of the viscosity. See chapter 15.15.2. • When activating the compensation for a liquid with a non-constant viscosity, the result of the entered equation is negative or equal to 0. See chapter 15.15.3, 15.15.4, 15.15.5.
What to do?	<p>→ When activating the compensation for a liquid with a constant viscosity, enter a positive value of the viscosity.</p> <p>→ When activating the compensation for a liquid with a non-constant viscosity, make sure the liquid temperature is in the range covered by the equation.</p> <p>→ When activating the compensation for a liquid with a non-constant viscosity, make sure you have entered correct constant values.</p>

24.9 Messages due to device internal diagnostics

24.9.1 Message "Overvoltage detected"

Message	Overvoltage detected
Symbol displayed in the information bar	
Possible cause	The supply voltage of the device is higher than or equal to the permitted maximum error value. See chapter 12.7 Monitoring the device supply voltage or the device temperature .
What to do?	<p>→ Energize the device with a 12...35 V DC voltage.</p> <p>As soon as the supply voltage value returns to within the permitted range, the error is automatically reset.</p>

24.9.2 Message "Undervoltage detected"

Message	Undervoltage detected
Symbol displayed in the information bar	
Possible cause	The supply voltage of the device is lower than or equal to the permitted minimum error value. See chapter 12.7 Monitoring the device supply voltage or the device temperature .
What to do?	→ Energize the device with a 12...35 V DC voltage. As soon as the supply voltage value returns to within the permitted range, the error is automatically reset.

24.9.3 Message "Voltage is above the warning limit"

Message	Voltage is above the warning limit
Symbol displayed in the information bar	
Possible cause	The supply voltage of the device is higher than or equal to the permitted maximum warning value set in chapter 12.7.2 Changing the 2 warning limit values .
What to do?	→ Energize the device with a 12...35 V DC voltage. As soon as the supply voltage value returns to within the permitted range, the warning is automatically reset.

24.9.4 Message "Voltage is below the warning limit"

Message	Voltage is below the warning limit
Symbol displayed in the information bar	
Possible cause	The supply voltage of the device is lower than or equal to the permitted minimum warning value plus the hysteresis value, both set in chapter 12.7.2 Changing the 2 warning limit values .
What to do?	→ Energize the device with a 12...35 V DC voltage. → If needed, change the limit value set in chapter 12.7.2 . As soon as the supply voltage value returns to within the permitted range, the warning is automatically reset.

24.9.5 Message "Battery voltage is below the warning limit"

Message	Battery voltage is below the warning limit
Symbol displayed in the information bar	
Possible cause	The voltage of the battery is under the low limit value. See chapter 12.8 . The battery allows the internal clock to run for 7 days at ambient temperature when the power supply of the device is switched off or too low.
What to do?	→ Energize the device with a 12...35 V DC voltage to load the battery. As soon as the battery voltage value returns to within the permitted range, the warning is automatically reset.

24.9.6 Message "bÜS event: bus connection lost / not available"

Message	bÜS event: bus connection lost / not available
Symbol displayed in the information bar	
Possible cause	The device is configured to send the measured process data to bÜS or to a CANopen fieldbus but does not find any other network participant.
What to do?	→ Set the Bus mode to Standalone . See chapter 12.6.7 .

24.9.7 Message "Overtemperature detected"

Message	Overtemperature detected
Symbol displayed in the information bar	
Possible cause	The internal temperature of the device is higher than the permitted maximum error value (+85 °C). See chapter 12.7 Monitoring the device supply voltage or the device temperature .
What to do?	→ Make sure the internal temperature of the device is less than +85 °C. As soon as the internal temperature value returns to within the permitted range, the error is automatically reset.

24.9.8 Message "Undertemperature detected"

Message	Undertemperature detected
Symbol displayed in the information bar	
Possible cause	The internal temperature of the device is lower than the permitted minimum error value (–40 °C). See chapter 12.7 Monitoring the device supply voltage or the device temperature .
What to do?	→ Make sure the internal temperature of the device is higher than –40 °C. As soon as the internal temperature value returns to within the permitted range, the error is automatically reset.

24.9.9 Message "Temperature is above the warning limit"

Message	Temperature is above the warning limit
Symbol displayed in the information bar	
Possible cause	The internal temperature of the device is higher than the permitted maximum warning value set in chapter 12.7.2 Changing the 2 warning limit values .
What to do?	→ Make sure the internal temperature of the device is less than the maximum warning value. As soon as the internal temperature value returns to within the permitted range, the error is automatically reset.

24.9.10 Message "Temperature is below the warning limit"

Message	Temperature is below the warning limit
Symbol displayed in the information bar	
Possible cause	The internal temperature of the device is lower than the permitted minimum warning value set in chapter 12.7.2 Changing the 2 warning limit values .
What to do?	→ Make sure the internal temperature of the device is higher than the minimum warning value. As soon as the internal temperature value returns to within the permitted range, the error is automatically reset.

24.9.11 Message "Internal message store overflow"

Message	Internal message store overflow
Symbol displayed in the information bar	
Possible cause	The number of messages generated by the device is higher than the memory capacity.
What to do?	→ Make sure the limits set for the monitoring of the process values are correct.

24.9.12 Message "No signals from interdigital transducer"

Message	No signals from interdigital transducer
Symbol displayed in the information bar	-
Possible cause	The sensor is not operating correctly.
What to do?	→ Send the complete device back to Bürkert because the sensor must be replaced.

24.9.13 Message "No temperature sensor detected"

Message	No temperature sensor detected
Symbol displayed in the information bar	
Possible cause	The temperature of the liquid can neither be measured nor compensated.
What to do?	→ If the temperature of the liquid must be measured, send the complete device back to Bürkert because the sensor must be replaced.

24.9.14 Message "Pipe characteristics have changed: check limits values"

Message	Pipe characteristics have changed: check limits values
Symbol displayed in the information bar	 (symbol changed)
Possible cause	The transmitter has been associated with another sensor.
What to do?	→ Make sure all the settings related to the flow rate measurement are still correct.

24.9.15 Message "Measure board is in boot starter mode, no firmware found n°1"

Message	Measure board is in boot starter mode, no firmware found n°1
Symbol displayed in the information bar	
Possible cause	The firmware of the measurement board is lost or is not valid.
What to do?	→ Start the device again. → If the error is still there, send the device back to Bürkert.

24.9.16 Message "Measured values cannot be used"

Message	Measured values cannot be used
Symbol displayed in the information bar	-
Possible cause	The device cannot measure the liquid parameters, for example, because there are too many bubbles in the liquid or the sensor tube is not completely filled.
What to do?	→ Make sure there is no problem in the installation.

24.9.17 Message "Communication between transmitter PCB and measurement PCB has been interrupted n°x"

Message	Communication between transmitter PCB and measurement PCB has been interrupted n°x
Symbol displayed in the information bar	
Possible cause	There is no communication between the sensor and the transmitter.
What to do?	→ Make sure the cable connecting the sensor to the transmitter is not broken and correctly plugged in. See chapter 7.3.1 Changing the position of the transmitter on the sensor .

24.9.18 Message "The measurement board bootloader operation failed n° 1"

Message	The measurement board bootloader operation failed n° 1
Symbol displayed in the information bar	
Possible cause	During the firmware update, the sensor software could not be updated.
What to do?	→ Send the device back to Bürkert.

24.9.19 Message "An error occurred during communication"

Message	An error occurred during communication
Symbol displayed in the information bar	
Possible cause	The flat cable that connects the sensor to the transmitter may be damaged.
What to do?	→ Make sure the flat cable is correctly connected. → If the cable is damaged, send the device back to Bürkert.

24.9.20 Message "Max. flow rate"

Message	Max. flow rate
Symbol displayed in the information bar	 (symbol not linked to a user setting)
Possible cause	The maximum flow rate is measured in the pipe. The flow rate in the tube is higher than 10 m/s, whatever the DN of the tube.
What to do?	→ Make sure the flow rate value is less than 10 m/s.

24.9.21 Message "Max temperature"

Message	Max temperature
Symbol displayed in the information bar	 (symbol not linked to a user setting)
Possible cause	The temperature in the tube is higher than 150 °C. The maximum liquid temperature is measured in the pipe. This message does not depend on the liquid temperature limits set by the user.
What to do?	→ Make sure the liquid temperature is in the permitted range.

24.9.22 Message "Totalizer 1 stopped" / "Totalizer 2 stopped" or "Mass totalizer 1 stopped" / "Mass totalizer 2 stopped"

Message	Totalizer 1 stopped / Totalizer 2 stopped or Mass totalizer 1 stopped / Mass totalizer 2 stopped
Symbol displayed in the information bar	-
Possible cause	The related totalizer / mass totalizer has been stopped by the user.
What to do?	→ If needed, start the totalizer / mass totalizer again.

24.9.23 Message "Totalizer 1 started" / "Totalizer 2 started" or "Mass totalizer 1 started" / "Mass totalizer 2 started"

Message	Totalizer 1 started / Totalizer 2 started or Mass totalizer 1 started / Mass totalizer 2 started
Symbol displayed in the information bar	-
Possible cause	The related totalizer / mass totalizer has been started by the user.
What to do?	-

24.10 Messages due to calibration or simulation

24.10.1 Message "Calibration result out of range"

Message	Calibration result out of range
Symbol displayed in the information bar	 (symbol changed)
Possible cause	<p>The calibration has failed. The calibration has failed because of 1 of the possible causes:</p> <ul style="list-style-type: none"> • An event such as Change of liquid or Sound cond. out of range has been generated during the calibration. • The calculated offset of the DF is lower than 0.5 or higher than 2. • The calculated offset of the acoustic transmission factor is lower than 0.5 or higher than 2.
What to do?	<p>→ Make sure the liquid is the same during the calibration procedure.</p> <p>→ Make sure the conditions are met to measure the flow rate correctly.</p> <p>→ Do a new calibration.</p>

24.10.2 Message "Zero calibration cancelled, the flow rate is higher than 5 % of full scale"

Message	Zero calibration cancelled, the flow rate is higher than 5 % of full scale
Symbol displayed in the information bar	
Possible cause	The calibration has failed because the flow rate is less than 5 % of the full scale.
What to do?	<p>→ Make sure the flow is stopped in the pipe.</p> <p>→ Do a new calibration.</p>

24.10.3 Message "Calibration cancelled"

Message	Calibration cancelled
Symbol displayed in the information bar	
Possible cause	The user has interrupted a calibration of the zero flow, before the waiting time of 30 seconds has elapsed.
What to do?	→ Do a new calibration and observe the given instructions.

24.10.4 Message "Calibration cancelled, the flow rate is less than 5 % of the full scale"

Message	Calibration cancelled, the flow rate is less than 5 % of the full scale
Symbol displayed in the information bar	
Possible cause	The calibration has failed because the flow rate is less than 5 % of the full scale.
What to do?	→ Make sure the flow rate is higher than 5 % of the full scale. → Do a new calibration.

24.10.5 Message "Resulting K factor is less than 0.8 or higher than 1.2"

Message	Resulting K factor is less than 0.8 or higher than 1.2
Symbol displayed in the information bar	
Possible cause	When calibrating the K factor by using a teach-in procedure depending on the flow rate or depending on a known volume, you have entered a reference value that varies for $\pm 20\%$ from the measured value.
What to do?	→ Do a new calibration. → Enter a correct reference value.

24.10.6 Message "Resulting offset is higher than 10 °C, 18 °F"

Message	Resulting offset is higher than 10 °C, 18 °F
Symbol displayed in the information bar	
Possible cause	When calibrating the offset value of the liquid temperature, you have entered a reference value that varies for $\pm 10\text{ °C}$ (18 °F) from the measured value.
What to do?	→ Do a new calibration. → Enter a correct reference value.

24.10.7 Message "Test mode activated"

Message	Test mode activated
Symbol displayed in the information bar	
Possible cause	The test of an output has been started by the user.
What to do?	→ If needed, complete the test.

24.10.8 Message "Simulation mode active"

Message	Simulation mode active
Symbol displayed in the information bar	
Possible cause	A measurement value is being simulated.
What to do?	→ As soon as the simulation is completed, the message is reset.

24.11 Messages due to the monitoring of process values

24.11.1 Message "Flow rate too high"

Message	Flow rate too high
Symbol displayed in the information bar	
Possible cause	The flow rate value is higher than the permitted maximum error value set in chapter 15.4.7 Changing the error limits, the warning limits and the hysteresis of the volume flow rate
What to do?	As soon as the flow rate returns to within the permitted range, the error is automatically reset.

Message	Flow rate too high
Symbol displayed in the information bar	
Possible cause	The flow rate value is higher than the permitted maximum warning value set in chapter 15.4.7 Changing the error limits, the warning limits and the hysteresis of the volume flow rate
What to do?	As soon as the flow rate returns to within the permitted range, the warning is automatically reset.

24.11.2 Message "Flow rate too low"

Message	Flow rate too low
Symbol displayed in the information bar	
Possible cause	The flow rate value is lower than the permitted minimum error value set in chapter 15.4.7 Changing the error limits, the warning limits and the hysteresis of the volume flow rate
What to do?	As soon as the flow rate returns to within the permitted range, the error is automatically reset.

Message	Flow rate too low
Symbol displayed in the information bar	
Possible cause	The flow rate value is lower than the permitted minimum warning value set in chapter 15.4.7 Changing the error limits, the warning limits and the hysteresis of the volume flow rate
What to do?	As soon as the flow rate returns to within the permitted range, the warning is automatically reset.

24.11.3 Message "Temperature too high"

Message	Temperature too high
Symbol displayed in the information bar	
Possible cause	The value of the liquid temperature is higher than the permitted maximum error value set in chapter 15.6.7 Changing the error limits, the warning limits and the hysteresis of the liquid temperature .
What to do?	As soon as the flow rate returns to within the permitted range, the error is automatically reset.

Message	Temperature too high
Symbol displayed in the information bar	
Possible cause	The value of the liquid temperature is higher than the permitted maximum warning value set in chapter 15.6.7 Changing the error limits, the warning limits and the hysteresis of the liquid temperature .
What to do?	As soon as the flow rate returns to within the permitted range, the warning is automatically reset.

24.11.4 Message "Temperature too low"

Message	Temperature too low
Symbol displayed in the information bar	
Possible cause	The value of the liquid temperature is lower than the permitted minimum error value set in chapter 15.6.7 Changing the error limits, the warning limits and the hysteresis of the liquid temperature .
What to do?	As soon as the value of the liquid temperature returns to within the permitted range, the error is automatically reset.

Message	Temperature too low
Symbol displayed in the information bar	
Possible cause	The value of the liquid temperature is lower than the permitted minimum warning value set in chapter 15.6.7 Changing the error limits, the warning limits and the hysteresis of the liquid temperature .
What to do?	As soon as the value of the liquid temperature returns to within the permitted range, the warning is automatically reset.

24.11.5 Message "Value totalizer 1 too high" / "Value totalizer 2 too high" or "Value mass totalizer 1 too high" / "Value mass totalizer 2 too high"

Message	Value totalizer 1 too high / Value totalizer 2 too high or Value mass totalizer 1 too high / Value mass totalizer 2 too high
Symbol displayed in the information bar	
Possible cause	The value of the totalizer / mass totalizer is higher than the permitted maximum error value set in chapter 15.10.5 Changing the error limits, the warning limits and the hysteresis of each volume totalizer .
What to do?	As soon as the value of the totalizer / mass totalizer returns to within the permitted range, the error is automatically reset.

Message	Value totalizer 1 too high / Value totalizer 2 too high or Value mass totalizer 1 too high / Value mass totalizer 2 too high
Symbol displayed in the information bar	
Possible cause	The value of the totalizer / mass totalizer is higher than the permitted maximum warning value set in chapter 15.10.5 Changing the error limits, the warning limits and the hysteresis of each volume totalizer .
What to do?	As soon as the value of the totalizer / mass totalizer returns to within the permitted range, the warning is automatically reset.

24.11.6 Message "Value totalizer 1 too low" / "Value totalizer 2 too low" or "Value mass totalizer 1 too low" / "Value mass totalizer 2 too low"

Message	Value totalizer 1 too low / Value totalizer 2 too low or Value mass totalizer 1 too low / Value mass totalizer 2 too low
Symbol displayed in the information bar	
Possible cause	The value of the totalizer / mass totalizer is lower than the permitted minimum error value set in chapter 15.10.5 Changing the error limits, the warning limits and the hysteresis of each volume totalizer .
What to do?	As soon as the value of the totalizer / mass totalizer returns to within the permitted range, the error is automatically reset.

Message	Value totalizer 1 too low / Value totalizer 2 too low or Value mass totalizer 1 too low / Value mass totalizer 2 too low
Symbol displayed in the information bar	
Possible cause	The value of the totalizer / mass totalizer is lower than the permitted minimum warning value set in chapter 15.10.5 Changing the error limits, the warning limits and the hysteresis of each volume totalizer .
What to do?	As soon as the value of the totalizer / mass totalizer returns to within the permitted range, the warning is automatically reset.

24.11.7 Message "Fluid velocity too high"

Message	Fluid velocity too high
Symbol displayed in the information bar	
Possible cause	The value of the liquid velocity is higher than the permitted maximum error value set in chapter 15.8.7 Changing the error limits, the warning limits and the hysteresis of the liquid velocity .
What to do?	As soon as the value of the liquid velocity returns to within the permitted range, the error is automatically reset.

Message	Fluid velocity too high
Symbol displayed in the information bar	
Possible cause	The value of the liquid velocity is higher than the permitted maximum warning value set in chapter 15.8.7 Changing the error limits, the warning limits and the hysteresis of the liquid velocity .
What to do?	As soon as the value of the liquid velocity returns to within the permitted range, the warning is automatically reset.

24.11.8 Message "Fluid velocity too low"

Message	Fluid velocity too low
Symbol displayed in the information bar	
Possible cause	The value of the liquid velocity is lower than the permitted minimum error value set in chapter 15.8.7 Changing the error limits, the warning limits and the hysteresis of the liquid velocity .
What to do?	As soon as the value of the liquid velocity returns to within the permitted range, the error is automatically reset.

Message	Fluid velocity too low
Symbol displayed in the information bar	
Possible cause	The value of the liquid velocity is lower than the permitted minimum warning value set in chapter 15.8.7 Changing the error limits, the warning limits and the hysteresis of the liquid velocity .
What to do?	As soon as the value of the liquid velocity returns to within the permitted range, the warning is automatically reset.

24.11.9 Message "DF too high"

Message	DF too high
Symbol displayed in the information bar	
Possible cause	The value of the DF is higher than the permitted maximum error value set in chapter 15.12.8 Changing the error limits, the warning limits and the hysteresis of the differentiation factor .
What to do?	As soon as the value of the DF returns to within the permitted range, the error is automatically reset.

Message	DF too high
Symbol displayed in the information bar	
Possible cause	The value of the DF is higher than the permitted maximum warning value set in chapter 15.12.8 Changing the error limits, the warning limits and the hysteresis of the differentiation factor .
What to do?	As soon as the value of the DF returns to within the permitted range, the warning is automatically reset.

24.11.10 Message "DF too low"

Message	DF too low
Symbol displayed in the information bar	
Possible cause	The value of the DF is lower than the permitted minimum error value set in chapter 15.12.8 Changing the error limits, the warning limits and the hysteresis of the differentiation factor .
What to do?	As soon as the value of the DF returns to within the permitted range, the error is automatically reset.

Message	DF too low
Symbol displayed in the information bar	
Possible cause	The value of the DF is lower than the permitted minimum warning value set in chapter 15.12.8 Changing the error limits, the warning limits and the hysteresis of the differentiation factor .
What to do?	As soon as the value of the DF returns to within the permitted range, the warning is automatically reset.

24.11.11 Message "Acoustic transmission factor too high"

Message	Acoustic transmission factor too high
Symbol displayed in the information bar	
Possible cause	The value of the acoustic transmission factor is higher than the permitted maximum error value set in chapter 15.13.6 Changing the error limits, the warning limits and the hysteresis of the acoustic transmission factor .
What to do?	As soon as the value of the acoustic transmission factor returns to within the permitted range, the error is automatically reset.

Message	Acoustic transmission factor too high
Symbol displayed in the information bar	
Possible cause	The value of the acoustic transmission factor is higher than the permitted maximum warning value set in chapter 15.13.6 Changing the error limits, the warning limits and the hysteresis of the acoustic transmission factor .
What to do?	As soon as the value of the acoustic transmission factor returns to within the permitted range, the warning is automatically reset.

24.11.12 Message "Acoustic transmission factor too low"

Message	Acoustic transmission factor too low
Symbol displayed in the information bar	
Possible cause	The value of the acoustic transmission factor is lower than the permitted minimum error value set in chapter 15.13.6 Changing the error limits, the warning limits and the hysteresis of the acoustic transmission factor .
What to do?	As soon as the value of the acoustic transmission factor returns to within the permitted range, the error is automatically reset.

Message	Acoustic transmission factor too low
Symbol displayed in the information bar	
Possible cause	The value of the acoustic transmission factor is lower than the permitted minimum warning value set in chapter 15.13.6 Changing the error limits, the warning limits and the hysteresis of the acoustic transmission factor .
What to do?	As soon as the value of the acoustic transmission factor returns to within the permitted range, the warning is automatically reset.

24.11.13 Message "Density too high"

Message	Density too high
Symbol displayed in the information bar	
Possible cause	The value of the density is higher than the permitted maximum error value set in chapter 15.9.7 Changing the error limits, the warning limits and the hysteresis of the liquid density .
What to do?	As soon as the value of the density returns to within the permitted range, the error is automatically reset.

Message	Density too high
Symbol displayed in the information bar	
Possible cause	The value of the density is higher than the permitted maximum warning value set in chapter 15.9.7 Changing the error limits, the warning limits and the hysteresis of the liquid density .
What to do?	As soon as the value of the density returns to within the permitted range, the warning is automatically reset.

24.11.14 Message "Density too low"

Message	Density too low
Symbol displayed in the information bar	
Possible cause	The value of the density is lower than the permitted minimum error value set in chapter 15.9.7 Changing the error limits, the warning limits and the hysteresis of the liquid density .
What to do?	As soon as the value of the density returns to within the permitted range, the error is automatically reset.

Message	Density too low
Symbol displayed in the information bar	
Possible cause	The value of the density is lower than the permitted minimum warning value set in chapter 15.9.7 Changing the error limits, the warning limits and the hysteresis of the liquid density .
What to do?	As soon as the value of the density returns to within the permitted range, the warning is automatically reset.

24.11.15 Message "Concentration 1 too high" / "Concentration 2 too high"

Message	Concentration 1 too high / Concentration 2 too high
Symbol displayed in the information bar	
Possible cause	The value of the liquid concentration is higher than the permitted maximum error value set in chapter 15.7.8 Changing the error limits, the warning limits and the hysteresis of the liquid concentration .
What to do?	As soon as the value of the liquid concentration returns to within the permitted range, the error is automatically reset.

Message	Concentration 1 too high / Concentration 2 too high
Symbol displayed in the information bar	
Possible cause	The value of the liquid concentration is higher than the permitted maximum warning value set in chapter 15.7.8 Changing the error limits, the warning limits and the hysteresis of the liquid concentration .
What to do?	As soon as the value of the liquid concentration returns to within the permitted range, the warning is automatically reset.

24.11.16 Message "Concentration 1 too low" / "Concentration 2 too low"

Message	Concentration 1 too low / Concentration 2 too low
Symbol displayed in the information bar	
Possible cause	The value of the liquid concentration is lower than the permitted minimum error value set in chapter 15.7.8 Changing the error limits, the warning limits and the hysteresis of the liquid concentration .
What to do?	As soon as the value of the liquid concentration returns to within the permitted range, the error is automatically reset.

Message	Concentration 1 too low / Concentration 2 too low
Symbol displayed in the information bar	
Possible cause	The value of the liquid concentration is lower than the permitted minimum warning value set in chapter 15.7.8 Changing the error limits, the warning limits and the hysteresis of the liquid concentration .
What to do?	As soon as the value of the liquid concentration returns to within the permitted range, the warning is automatically reset.

24.12 Messages due to diagnostics events

24.12.1 Message "Diagnostic is active"

Message	Diagnostic is active
Symbol displayed in the information bar	
Possible cause	All the diagnostics are active on the device. See chapter 15.14 Diagnostics: monitoring special events that occur in the process, on the sensor or on the electronics .
What to do?	-

24.12.2 Message "Diagnostic is inactive"

Message	Diagnostic is inactive
Symbol displayed in the information bar	-
Possible cause	All the diagnostics are inactive on the device. See chapter 15.14 Diagnostics: monitoring special events that occur in the process, on the sensor or on the electronics .
What to do?	-

24.12.3 Message "Not totally filled"

Message	Not totally filled
Symbol displayed in the information bar	Depends on the device status the event is associated to.
Possible cause	<p>The calibration has failed. The calibration has failed because of one of the possible causes:</p> <ul style="list-style-type: none"> • The sensor may be broken (valid for product variants with DN08). • The tube is not totally filled. Thus not all the sensors are in contact with the liquid and measurement is not possible. <p>The related event must be enabled. See chapter 15.14 Diagnostics: monitoring special events that occur in the process, on the sensor or on the electronics.</p>
What to do?	<p>→ Make sure the measurement tube is completely filled, for example by increasing the flow rate.</p> <p>→ If the message No signals from interdigital transducer is generated simultaneously, then send the product back to Bürkert.</p> <p>→ If the message Not totally filled remains, then send the product back to Bürkert.</p>

24.12.4 Message "Liquid out of range"

Message	Liquid out of range
Symbol displayed in the information bar	Depends on the device status the event is associated to.
Possible cause	<p>The speed of sound in the liquid is out of range.</p> <p>The related event must be enabled. See chapter 15.14 Diagnostics: monitoring special events that occur in the process, on the sensor or on the electronics.</p> <p>The density in the liquid is out of range.</p>
What to do?	<p>→ Make sure the liquid in the pipe meets the technical specifications given in the data sheet for the device and in chapter 6 Technical data.</p>

24.12.5 Message "Unstable flow rate"

Message	Unstable flow rate
Symbol displayed in the information bar	Depends on the device status the event is associated to.
Possible cause	<p>The flow rate is not stable. The standard deviation of the flow rate measurements is too high.</p> <p>The related event must be enabled. See chapter 15.14 Diagnostics: monitoring special events that occur in the process, on the sensor or on the electronics.</p>
What to do?	<p>→ Make sure the operation of the equipment in the process, such as pumps and process valves, is correct.</p>

24.12.6 Message "Low flow cut off"

Message	Low flow cut off
Symbol displayed in the information bar	Depends on the device status the event is associated to.
Possible cause	<p>The cut-off value of the flow rate has been used.</p> <p>The cut-off function must be enabled. See chapter 15.4.9 Enabling the cut-off function of the volume flow rate.</p> <p>The related event must be enabled. See chapter 15.14 Diagnostics: monitoring special events that occur in the process, on the sensor or on the electronics.</p>
What to do?	→ If necessary, increase the flow rate value until it is higher than the cut-off value.

24.12.7 Message "Change of liquid"

Message	Change of liquid
Symbol displayed in the information bar	Depends on the device status the event is associated to.
Possible cause	<p>A different liquid flows in the pipe.</p> <p>The message is active for 10 s on the display.</p> <p>The related event must be enabled. See chapter 15.14 Diagnostics: monitoring special events that occur in the process, on the sensor or on the electronics.</p>
What to do?	→ Make sure the liquid flowing in the pipe is the correct one.

24.12.8 Message "Backward flow"

Message	Backward flow
Symbol displayed in the information bar	Depends on the device status the event is associated to.
Possible cause	<p>The liquid flows in the opposite direction as the one set in chapter 17.4 Setting the direction of the flow.</p> <p>The related event must be enabled. See chapter 15.14 Diagnostics: monitoring special events that occur in the process, on the sensor or on the electronics.</p>
What to do?	→ Make sure the liquid flows in the correct direction.

24.12.9 Message "Sound conductivity out of range"

Message	Sound conductivity out of range
Symbol displayed in the information bar	Depends on the device status the event is associated to.
Possible cause	There are gas bubbles or solid particles in the liquid. The related event must be enabled. See chapter 15.14 Diagnostics: monitoring special events that occur in the process, on the sensor or on the electronics .
What to do?	→ Search for malfunctions in the process. → Make sure the liquid has no gas bubbles and no solid particles.

24.12.10 Message "AO1 open loop" or "AO3 open loop"

Message	AO1 open loop or AO3 open loop
Symbol displayed in the information bar	Depends on the device status the event is associated to.
Possible cause	There is a connection problem on the related output. The current measured in the current loop is too low compared to the expected output current. The related event must be enabled. See chapter 15.14 Diagnostics: monitoring special events that occur in the process, on the sensor or on the electronics .
What to do?	→ Make sure the wiring of the related output is correct.

24.12.11 Message "AO1 Diag error" or "AO3 Diag error"

Message	AO1 Diag error or AO3 Diag error
Symbol displayed in the information bar	Depends on the device status the event is associated to.
Possible cause	There is a connection problem on the related output or a high resistance is detected in the loop. The related event must be enabled. See chapter 15.14 Diagnostics: monitoring special events that occur in the process, on the sensor or on the electronics .
What to do?	→ Make sure all the cables are correctly connected. → If the related analogue output is not used, disable it. See chapter 18.4 Disabling an analogue output .

24.12.12 Message "DO2 overload" or "DO3 overload"

Message	DO2 overload or DO3 overload
Symbol displayed in the information bar	Depends on the device status the event is associated to.
Possible cause	An overload has been detected at the related digital output. A current higher than 700 mA has been detected at the related digital output. The output has switched. The related event must be enabled. See chapter 15.14 Diagnostics: monitoring special events that occur in the process, on the sensor or on the electronics .
What to do?	→ Make sure all the cables are correctly connected. → Make sure the current flowing through the related digital output is less than 700 mA.

24.13 Messages due to the industrial communication module

24.13.1 Message "No proper connection to the process control system"

Message	No proper connection to the process control system
Symbol displayed in the information bar	
Possible cause	There is no physical connection between the device and the control unit (e.g. a PLC) or no communication is established between the device and the control unit.
What to do?	→ Make sure all the cables are correctly connected. → Make sure the industrial communication settings are correct at the device and at the control unit (e.g. IP address).

24.13.2 Message "Cyclic data transfer has been slower than configured timeout"

Message	Cyclic data transfer has been slower than configured timeout
Symbol displayed in the information bar	
Possible cause	The parameter Communication Timeout is not correctly parametered. (timeout should be written without upper case t in the menu point)
What to do?	→ Set a higher time-out value. Refer to chapter 21.2.8 Choosing the communication timeout and enabling it .

24.13.3 Message "No or incorrect mapping file available"

Message	No or incorrect mapping file available
Symbol displayed in the information bar	
Possible cause	The device has no internal mapping file or the mapping file cannot be found.
What to do?	→ Contact the Bürkert service.

24.13.4 Message "Please select a protocol and restart the device"

Message	Please select a protocol and restart the device
Symbol displayed in the information bar	
Possible cause	No valid protocol has been set on the device.
What to do?	→ If the device is connected to an industrial network, set the correct protocol. Refer to chapter 21.2.1 Choosing the communication protocol . → Restart the device.

24.13.5 Message "Master tried to plug wrong module or submodule"

Message	Master tried to plug wrong module or submodule
Symbol displayed in the information bar	
Possible cause	The PROFINET GSDML file does not match with the Ethernet module of the device.
What to do?	→ Make sure that the correct GSDML file is used. → Make sure the device is correctly configured at the PLC.

24.13.6 Message "Initialization of industrial communication"

Message	Initialization of industrial communication
Symbol displayed in the information bar	
Possible cause	The device is initializing the industrial communication. The message is displayed at each device start.
What to do?	<p>→ Wait until the initialization is finished.</p> <p>→ If the message is not automatically removed, make sure the industrial communication settings are correct at the device and at the PLC (e.g. IP address).</p>

24.13.7 Message "Fieldbus master is running in stop mode"

Message	Fieldbus master is running in stop mode
Symbol displayed in the information bar	
Possible cause	<p>The Ethernet connection is established with the client (e.g. PLC) but the PLC is in stop mode.</p> <p>No cyclic data can be sent to the PLC.</p>
What to do?	→ To send cyclic data to the PLC, start the PLC in RUN mode.

25 SPARE PARTS AND ACCESSORIES

CAUTION

Risk of injury and/or damage caused by the use of unsuitable parts.

Incorrect accessories and unsuitable replacement parts may cause injuries and damage the device and the surrounding area.

- ▶ Use only original accessories and original replacement parts from Bürkert.

Spare part or accessory		Article number
Unlocking magnetic key		690309
5-pin M12 female and 5-pin M12 male straight cable plugs, moulded at each end of a 1 m shielded cable		772404
5-pin M12 female and 5-pin M12 male straight cable plugs, moulded at each end of a 3 m shielded cable		772405
Female M12 connector with a 120 Ω termination resistor		772424
Y plug adapter for the male M12 connector		772420
büS cable, 50 m		772413
büS cable, 100 m		772414
USB-büS interface set		772426

26 PACKAGING, TRANSPORT



CAUTION

Risk of injury due to a heavy device.

A heavy device can fall down during transport or during installation and cause injuries.

- ▶ Transport, install and dismantle a heavy device with the help of another person.
- ▶ Use appropriate tools.

NOTICE

Damage due to transport

Transport may damage an insufficiently protected device.

- ▶ Transport the device in shock-resistant packaging and away from humidity and dirt.
- ▶ Do not expose the device to temperatures that may exceed the admissible storage temperature range.
- ▶ Protect the electrical interfaces using protective plugs.

27 STORAGE



CAUTION

Risk of injury due to a heavy device.

A heavy device can fall down during transport or during installation and cause injuries.

- ▶ Transport, install and dismantle a heavy device with the help of another person.
- ▶ Use appropriate tools.

NOTICE

Poor storage can damage the device.

- ▶ Store the device in a dry place away from dust.
- ▶ Storage temperature of the device: $-20\text{ °C} \dots +70\text{ °C}$.

28 DISPOSAL OF THE DEVICE

NOTICE

Damage to the environment due to parts contaminated by the liquid.

- ▶ Dispose of the device and its packaging in an environmentally-friendly way.
- ▶ Comply with the regulations which concern the area of waste disposal.

Appendix

29 APPENDIX

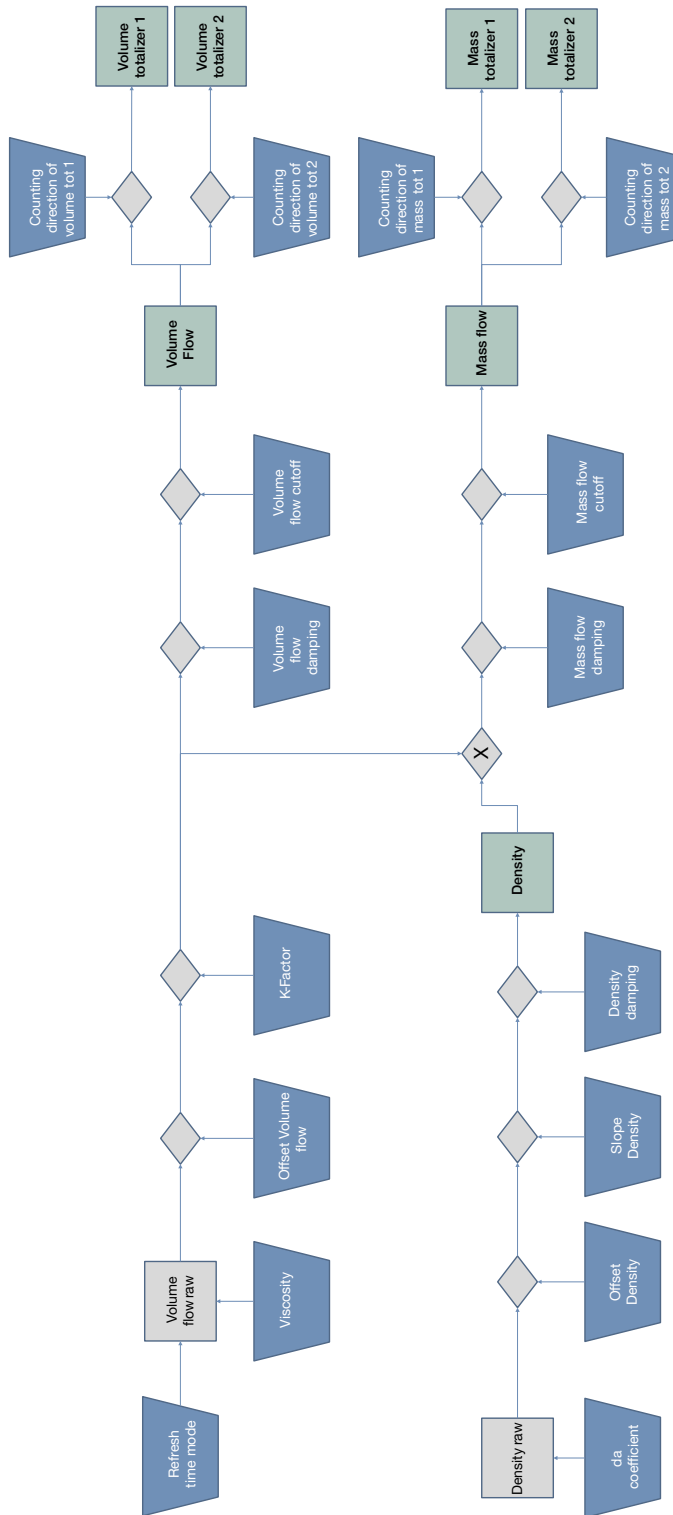

MAN 1000273158 EN Version: M Status: RL (released | freigegeben) printed: 22.06.2022

Fig. 70: Overview of user parameters affecting FLOWave measurements

