



Controller for apartments

CRA24-B3(P)

Room controller with three outputs:

- Supply air device
- Exhaust air device
- Heating valve

CRA24-B1P

3-step switch with one output

- Supply air/exhaust air device

Table of contents

System overview	3
Brief description CRA24-B3(P)	4
Brief description CRA24-B1P	5
Accessories	5
CRA24-B3(P)	
Technical data sheet	7
Technical data	7
Safety notes	7
Product features	8
Configuration	8
Electrical installation	8
Operating	9
Operating level 1 – Operation	9
Operating level 2 – Configuration	9
Operating level 3 – Service	9
Functions	10
Introduction	10
Function overview CRA24-B3(P)	10
Control strategy of air volume	11
Control strategy of room temperature	12
Reset MAX → COMF	13
Override functions	13
External temperature sensor (ai1)	14
Analogue outputs	15
CRA24-B1P	
Technical data sheet	17
Technical data	17
Safety notes	17
Product features	17
Electrical installation	17
Operating	18
Operating level 1 – Operation	18
Operating level 2 – Configuration	18
Operating level 3 – Service	18
Functions	19
Introduction	19
Function overview CRA24-B1P	19
Air volume control	19
Dimensions, installation, commissioning, service	21
Dimensions [mm]	21
Mechanical installation	21
Electrical installation	21
Design for supply / wire sizing	22
Commissioning / power on behaviour	22
Test and simulation mode	22
Internal function test	23
Control sequence simulation	23
Testing and setting of VAV controller	23

Single room controller



CRA24-B3



CRA24-B3P



CRA24-B1P

VAV applications



VAV-Compact

OEM product, i.e., VAV controller can be supplied only by the manufacturer of VAV units

LMV-D3-MP / NMV-D3-MP

Water Solutions



Rotary actuators and characterised control valves

R..K + TRD24 / R.. + TR24 / R.. + LR24A

General Air Solutions



Damper actuators

LM24A-MF / NM24A-MF / LM24A-MP / NM24A-MP

Accessories



Fan optimiser fan control (only for VAV systems)

COU24-A-MP



Service tool for VAV-Compact

ZTH-GEN



Setting for VAV-Compact MFT damper actuator

PC-Tool



Connecting cable ZTH-GEN for CRA24-B3(P), diagnostic socket 1/2

ZK1-VAV

Brief description CRA24-B3(P)

The CRA24-B3(P) room controller has been specially adapted to the requirements of controlled apartment ventilation. Thanks to its unique functions, e.g. the kitchen and bathroom overrides, the CRA24-B3(P) is optimised to applications in extremely airtight buildings. The system combines individual room comfort and minimum energy consumption in an economically optimised solution.

Pure ventilation systems, either equipped with VAV units or air control dampers, can be expanded with heating functions as required.

The CR24 controller generation forms the basis of modern single room concepts.

The microprocessor-controlled room temperature controller is perfectly adapted to the BELIMO actuators for motorised air and water control valves with respect to technology, functionality and handling.

The CRA24 apartment controllers can be combined or extended with the CR24 room temperature control range as required (see the separate documentation of the CR24 range).

Override kitchen

The kitchen hood fan or even the chimney extractor system sucks air from the rooms. This leads to a vacuum and it either becomes difficult to open doors or doors fly open at you when you open them. Controlled by the vapour kitchen hood fan or chimney ventilator, the CRA24-B3 can minimise these pressure differences through intelligent control of the supply air and exhaust air components.

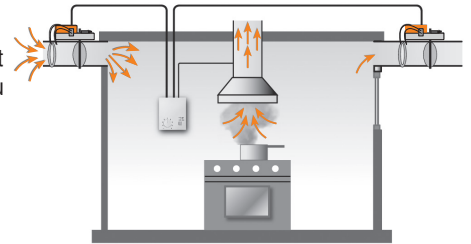

Override bathroom

In energy-efficient buildings with extremely airtight shells, it is extremely important to draw off damp air (showers, baths) as quickly as possible. This helps to minimise damage to the structural fabric caused by the formation of mould. The apartment ventilation can be switched to maximum air exchange via the light switch or a humidistat positioned in the corresponding exhaust air.

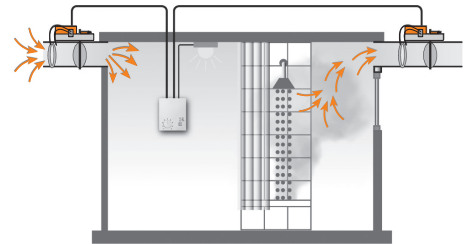

Device variants



Standard type CRA24-B3 with user interface (setpoint adjustment, mode switch and status display). For operation, see page 9.



Type CRA24-B3P with the same functions as the CRA24-B3, but with hidden setpoint adjustment.

Brief description CRA24-B1P

The CRA24-B1P is a simple controller that is optimised use in controlled apartment ventilation systems. Thanks to its simple operation, it is especially suitable for residential units in which continuous operation of the system is to be ensured. Together with the downstream VAV units, the air volumes can be adapted individually to the needs of the user.

The push-button on the controller front can be used to enable the

- COMF → Nominal ventilation
- MIN → Reduced ventilation
- MAX → Intensive ventilation

levels simply and safely. Three LEDs indicate the respectively active level.



Type CRA24-B1P with step switch via push-button.

Accessories

Mechanical accessories

Type	Description
CRZA-A	Spare cover without user interface
CRZW	Spare baseplate

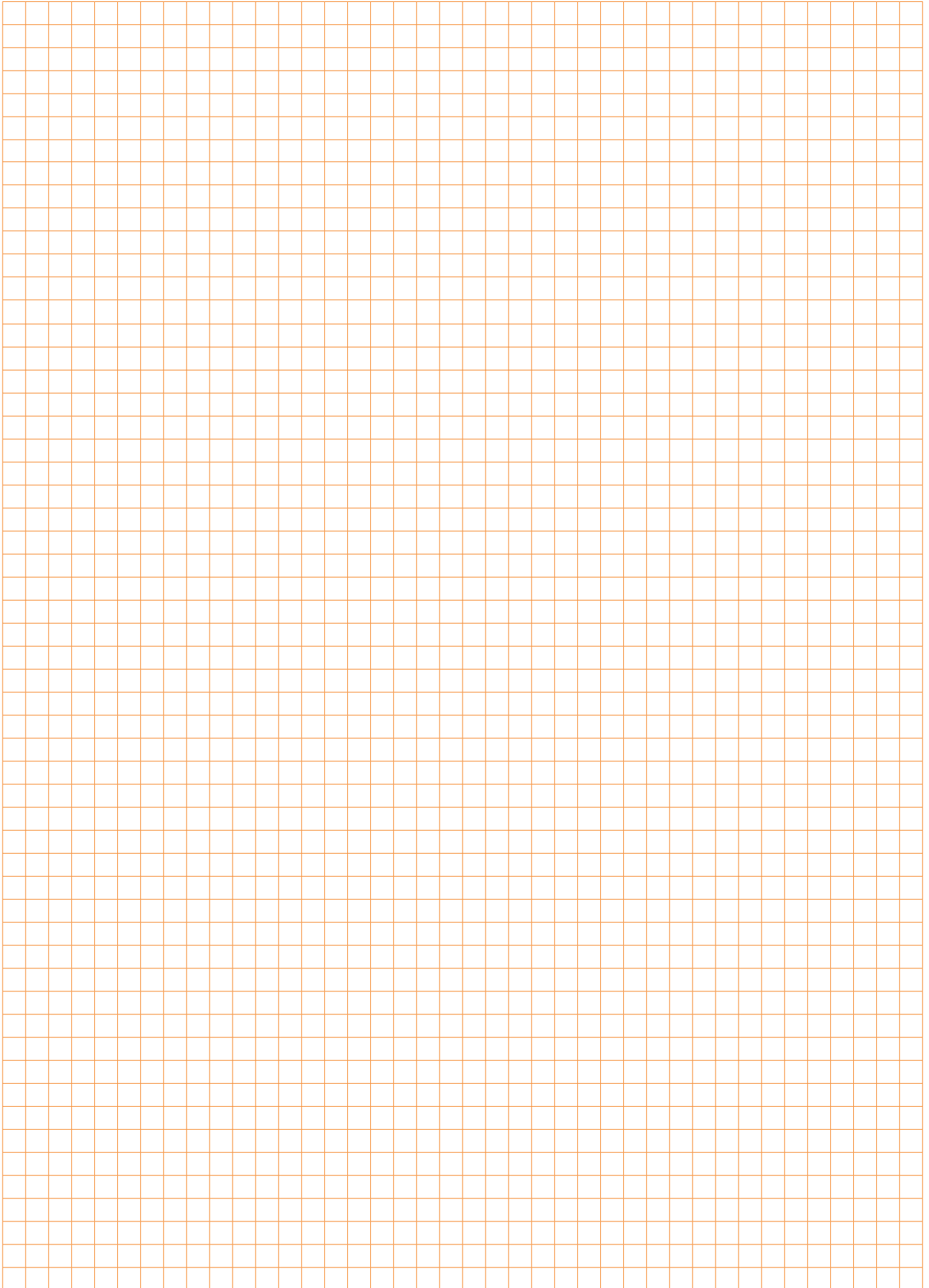

Room controllers for controlled apartment ventilation with three outputs:

- Analogue output ao1: Supply air device
 - VAV unit or damper actuator
- Analogue output ao2: Exhaust air device
 - VAV unit or damper actuator
- Output ao3: 2-point (on/off) or 3-point signal for a heating valve

Device variant

Type CRA24-B3P, same functions as the CRA24-B3, but with a hidden user interface.

Technical data

Electrical data	Nominal voltage	AC 24V 50/60 Hz
	Dimensioning	3 VA, without actuators
	Power supply range	AC 19.2 ... 28.8V
	Connections	Terminal block 1 ... 3: 2.5 mm ² Terminal block 4 ... 12: 1.5 mm ²
Functional data	Control characteristics	P
	– P-Band	Selectable: 1.5 K or 3.0 K
	External temperature sensor (ai1)	Type NTC, 5 kΩ, power supply range 10 ... 45°C e.g. Belimo Type TFK
	Setpoint	Adjustment range 15 ... 36°C (Default 21°C)
	– Energy hold off (EHO)	Heating –2 K
	Room temperature (frost protection)	14°C
	Max. room temperature monitoring	28°C
	Operation	
	– Mode switch and status display (LED)	COMF (green) – MIN (orange) – MAX (red)
	– Rotary knob for setpoint adjustment	30 ... 70% air / ±3 K temperature
Communication connection for field devices	2 x PP (for PC-Tool, ZTH-GEN, etc.)	
Inputs	1 x analogue, 3 x digital	
	– External temperature sensor (ai1)	Type NTC, 5 kΩ, power supply range 10 ... 45°C
	– Digital inputs (di1, di2, di3)	Contact load 10 mA
Output	3 x analogue or digital	
	– Supply air VAV system output (ao1)	2 ... 10V, max. 5 mA
	– Exhaust air VAV system output (ao2)	2 ... 10V, max. 5 mA
	– Heating output (ao3)	2-point / 3-point, AC 24V, source current max. 0.5 A / 10 VA (optimised for actuators with approx. 150 s running time)
Norms and Standards	Protection class	III Safety extra-low voltage
	Degree of protection	IP30 (EN 60529)
	Mode of operation	Type 1 (EN60730-1)
	Software class	A (EN 60730-1)
	EMC	CE according to 2004/108/EC
	Ambient conditions	
	– Operation	0 ... +50°C / 20 ... 90% r.h. (non-condensing)
	– Transport and storage	–25 ... +70°C / 20 ... 90% r.h. (non-condensing)
Dimensions / weight	Dimensions (H x W x D)	99 x 84 x 32 mm
	Weight	105 g
Housing colours	Baseplate	NCS2005-R80B light grey (corresponds approximately to RAL 7035)
	Cover	RAL 9003 Signal white

Safety notes

- The controller is not allowed to be used outside the specified field of application, especially not in aircraft or in any other airborne means of transport.
- It may only be installed by suitably trained personnel.
Legal regulations and regulations issued by authorities must be observed during installation.
- The device does not contain any parts that can be replaced or repaired by the user.
- The device contains electrical and electronic components and is not allowed to be disposed of as household refuse. All locally valid regulations and requirements must be observed.

Product features

Air volume control strategy	The air volume can be pre-selected and set to minimum, variable (dial: 30 ... 70%) and maximum using the push-button and the rotary knob on the controller front. This is especially suitable for applications requiring a defined air exchange. The heating output is not available.
Room temperature control strategy	The desired comfort temperature can be selected using the rotary knob. The room controller controls the air volumes as well as the heating valve on the basis of the set parameters.
Override kitchen	Pressure differences caused by the kitchen hood fan or the chimney extraction system are balanced out largely by reducing the exhaust air volume.
Override bathroom	Volume currents are increased to the maximum air change, e.g. in order to draw off humid air from rooms as quickly as possible.
Energy hold off (EHO)	The room is controlled in the energy saving mode, i.e. the VAV units are closed and the heating setpoint is lowered to the value for the room protection function during long periods of absence, for example.
Room protection (Frost)	If the current room temperature falls below 14 °C, the room protection function is activated.
External temperature sensor	An external temperature sensor can be connected to the analogue input ai1, e.g. in the exhaust air duct for calculating the average room temperature.

Configuration

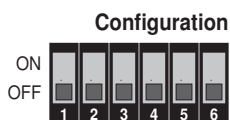

DIP	Default settings	
1	P-Band normal	P-Band wide
2	Air volume control strategy	Room temperature control strategy
3	Control sequence for air cooling	Control sequence for air heating
4	Reset MAX → COMF Off	Reset MAX → COMF 1 h
5	Max. temp. monitoring Off	Max. temp. monitoring On
6	Definition of heating output (ao3) 2-point actuator	Definition of heating output (ao3) 3-point actuator

Note

The functions are described in detail on pages 10 to 15.

Electrical installation

Wiring diagram

Notes

- Connection via safety isolating transformer. 
- Parallel connection of other actuators possible. Note the performance data.

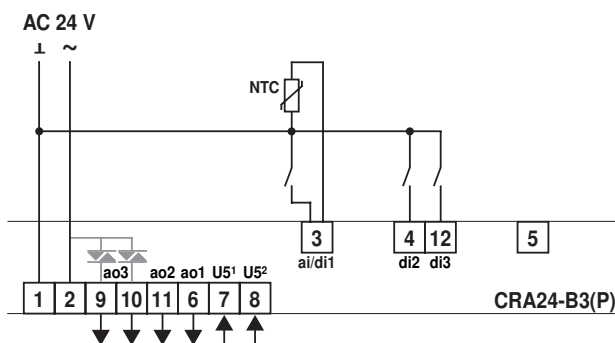

Inputs			Outputs		
3	ai1	External temperature sensor	6	ao1	System output VAV controller supply air
	di1	Energy hold off (EHO)	9/10	ao3	2-point / 3-point output heating
4	di2	Override kitchen	11	ao2	System output VAV controller exhaust air
5	–	Not used	Other connections		
12	di3	Override bathroom	7	PP1	Diagnostic socket VAV controller supply air
			8	PP2	Diagnostic socket VAV controller exhaust air

Operation level 1 – Operation

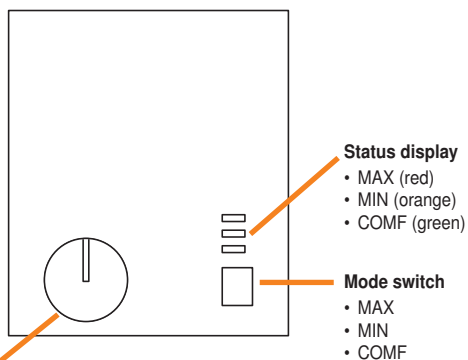

Rotary knob for setpoint adjustment (CRA24-B3 only)

- Control strategy air volume of 30 ... 70 %
- Control strategy room temperature ± 3 K

Operating mode / Setpoint

Mode switch and status display

One of three operating modes can be selected:

- **COMF – Comfort-oriented operating mode**
If the external control signals permit this, the room is maintained in the comfort state using the selected control strategy. All control functions are enabled.
- **MIN – Minimum operating mode**
The air volume is maintained to the minimum value that is set at the VAV controller. The heating valve regulates to the selected setpoint. Advantages: Energy saving mode during short absences.
- **MAX – Maximum operating mode**
The air volume is regulated to the maximum value that is set at the VAV controller. The heating valve is regulated to the set setpoint. Advantages: Maximum air exchange, e.g. during a party or fondue evening.

Operation level 2 – Configuration

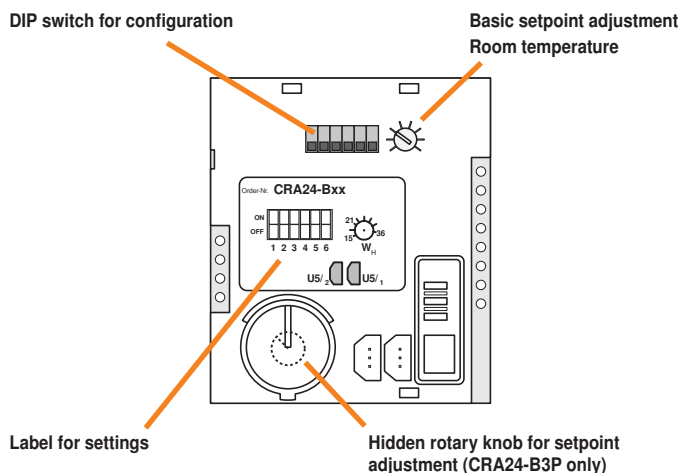

Application / Parameters

DIP switch for configuration

DIP switches 1 to 6

Basic setpoint adjustment of the room temperature W_H (heating setpoint)

Potentiometer 15 ... 36 °C (Default 21 °C)

Label for settings

Retaining the used settings (DIP switch and basic setpoint).

Operation level 3 – Service

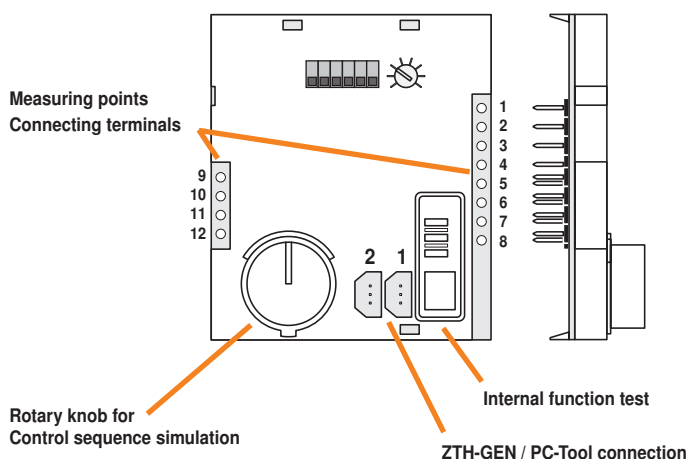

Test / Simulation

Connecting terminals measuring points

Measuring points for all connection terminals (also during operation).

Internal function test

A comprehensive internal function test can be started using the mode switch which enables a test of the controller including the nominal voltage (AC 24 V). The three LEDs (status display) display the statuses of the voltage level.

Control sequence simulation

The connected actuators as well as the control sequences can be simulated independent of the room temperature using the rotary knob for the setpoint adjustment.

ZTH-GEN / PC-Tool connection

The diagnostic sockets 1 and 2 help in PP communication with the connected Belimo MFT actuators or VAV-Compact controllers. This makes physical access to the field devices unnecessary.

Introduction

The control functions of the CRA24-B3(P) define the behaviour of the control outputs or influence the current setpoint.

The operation can be automated and the comfort and energy saving potential can be increased using the appropriate sensor system on the input side.

The relevant functions have been individually described below

We usually differentiate between two different control strategy that have been described below in more detail.

Function overview

Supply	AC 24V / 50/60 Hz
Application	<ul style="list-style-type: none"> – Air volume or room temperature control in comfort zone – Internal temperature sensor (Type NTC, Power supply range 10 ... 45°C) – Setpoint (setting range 30 ... 70% air / 15 ... 36°C temperature)
Operating	<ul style="list-style-type: none"> – Mode selection switch: COMF – MIN – MAX – Mode indication LED: COMF – MIN – MAX – Setpoint adjustment rotary knob (CRA24-B3P hidden): 30 ... 70% air / ±3 K temperature
4 inputs	<ul style="list-style-type: none"> – Override kitchen – Override bathroom – Energy hold off (EHO) – External temperature sensor (Type NTC 5 kΩ, operating range 10 ... 45°C)
3 outputs	<ul style="list-style-type: none"> – 2 ... 10 V system output for supply air: Belimo VAV controller, damper actuator – 2 ... 10 V system output for exhaust air: Belimo VAV controller, damper actuator – 2-point (thermal actuator) / 3-point heating output
Functions	<ul style="list-style-type: none"> – Control characteristics: P – P-Band, switchable – Control strategy can be switched (air volume / room temperature) – Air sequence can be switched (cooling / heating) – Room temperature monitoring (min and max) – Internal function test with nominal voltage test – Commissioning mode with simulation of output and sequence – Diagnostics of VAV controllers using an integrated PC-Tool connection
Installation	Surface mounting with flush-mounted or surface-mounted connection

Application documentation

A comprehensive documentation with specific applications has been provided for the CRA24-3(P) controller and this documentation is constantly updated.

Air volume control strategy

The air volume can be pre-selected and set to minimum, variable (dial: 30 ... 70%) and maximum using the push-button and the rotary knob on the controller front. This is especially suitable for applications requiring a defined air exchange. The heating output is not available.

Settings with ZTH-GEN

The operating volumetric flow setting \dot{V}_{min} / \dot{V}_{max} of the VAV controllers can be modified/checked with the help of the ZTH-GEN. Connection to diagnostic sockets 1 and 2.

Application with damper actuator instead of VAV controllers

Use of damper actuators is usually possible but it must still be taken into account that this application cannot detect and regulate pressure changes in the air duct system (pre-pressure-dependent operation).

Note
The MIN / MAX levels **cannot** be changed when using an -SR standard actuator (mode 0 ... 10V), e.g. LM24A-SR!

Type: LM24A-MF / NM24A-MF

The MIN/MAX levels of the MF actuator can be programmed with the ZTH-GEN service tool or the Belimo PC-Tool and then be loaded in L/NM24A-MF.

The "Air volume" control strategy is configured with the help of DIP switch 2 = OFF.

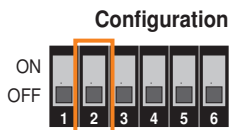



Operating mode COMF	Operating mode MIN	Operating mode MAX
<ul style="list-style-type: none"> The air volume can be set in the range of 30 ... 70% of the operating volume current range \dot{V}_{min} ... \dot{V}_{max} programmed on the VAV controller. Setting of the VAV controller (example): <ul style="list-style-type: none"> - \dot{V}_{min} 50 m³/h - \dot{V}_{max} 100 m³/h - Setting range of the rotary knob: 65 ... 85 m³/h The heating valve is not supported by the air volume control strategy Air volume setting: <ul style="list-style-type: none"> - CRA24-B3 → Rotary knob on the controller front - CRA24-B3P → Potentiometer under the front cover 	<ul style="list-style-type: none"> The connected VAV units are set to the minimum air volume (\dot{V}_{min}) selected on the controller. The heating valve is not supported by the air volume control strategy 	<ul style="list-style-type: none"> The connected VAV units are set to the maximum air volume (\dot{V}_{max}) selected on the controller. The heating valve is not supported by the air volume control strategy <p>Reset MAX → COMF with DIP switch 4 (see page 13):</p> <ul style="list-style-type: none"> DIP switch 4 = OFF: Manual reset DIP switch 4 = ON: Automatic reset after one hour

Room temperature control strategy

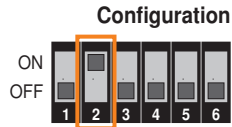
The desired comfort temperature can be selected using the rotary knob. The room controller controls the air volumes as well as the heating valve on the basis of the selected parameters.

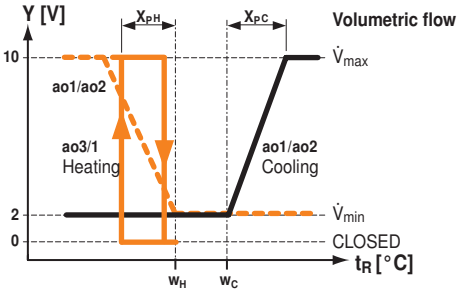
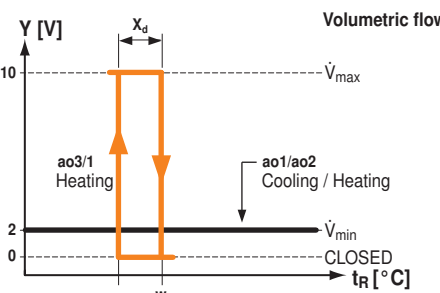
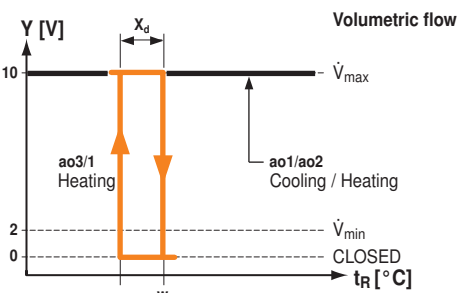
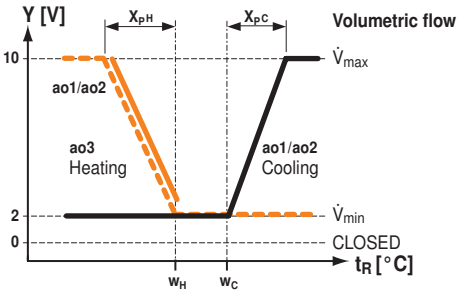
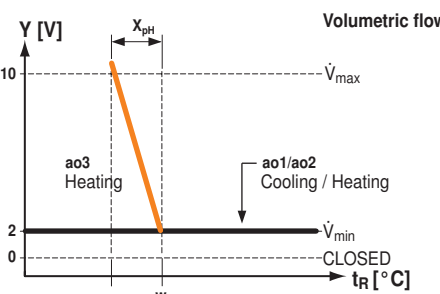
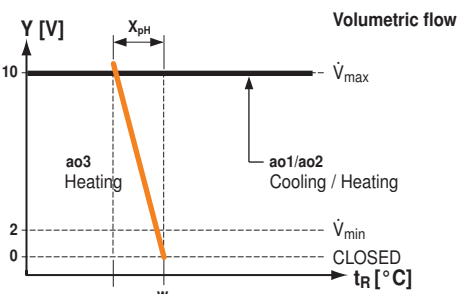
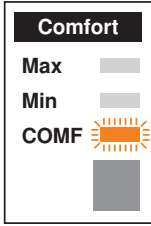

The "Room temperature" control strategy is configured with the help of DIP switch 2 = ON.

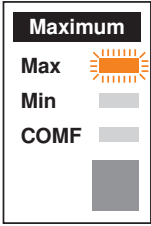
Operating mode COMF	Operating mode MIN	Operating mode MAX
<ul style="list-style-type: none"> The temperature setpoint can be selected between 15°C ... 36°C on the "Basic setpoint adjustment" potentiometer under the cover (operation level 2). Correction of the setpoint: <ul style="list-style-type: none"> CRA24-B3 via the rotary knob on the controller front CRA24-B3P potentiometer under the front cover The reference signal ao1/ao2 on the VAV controller depends on the selected sequence (cooling / heating). DIP switch 3: OFF = cooling / ON = heating The heating valve regulates the set setpoint. 	<ul style="list-style-type: none"> The connected VAV controllers are set to the minimum air volume (\dot{V}_{min}) selected on the controller. The heating valve regulates to the selected setpoint. 	<ul style="list-style-type: none"> The connected VAV controllers are set to the maximum air volume (\dot{V}_{max}) selected on the controller. The heating valve regulates to the selected setpoint. <p>Reset MAX → COMF with DIP switch 4 (see page 13):</p> <ul style="list-style-type: none"> DIP switch 4 = OFF: Manual reset DIP switch 4 = ON: Automatic reset after one hour
Variant for 2-point heating: DIP switch 6 = OFF	Variant for 2-point heating: DIP switch 6 = OFF	Variant for 2-point heating: DIP switch 6 = OFF
		
Variant for 3-point heating: DIP switch 6 = ON	Variant for 3-point heating: DIP switch 6 = ON	Variant for 3-point heating: DIP switch 6 = ON
		
		

Reset MAX → COMF



DIP switch 4 = OFF:

The reset from the manually selected operating mode MAX is accomplished solely by means of the mode switch on the controller front.



DIP switch 4 = ON:

The reset from the manually selected operating mode MAX will be done automatically after a one-hour delay. The operating mode can also be changed manually during this time.

Override functions

If several override functions are switched on, the one with the highest priority is activated.

Priority 1: Frost (Building protection)

This function becomes active if the room temperature falls below 14°C room protection temperature (frost protection function).

Component	Air volume	Room temperature
Supply air (ao1)	100% = \dot{V}_{max}	100% = \dot{V}_{max}
Extract air (ao2)	100% = \dot{V}_{max}	100% = \dot{V}_{max}
Heating valve (ao3)	OPEN	OPEN

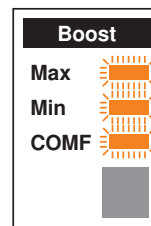

Priority 2: Kitchen (di2) (Chimney extractor system)

In order to minimise the pressure differences within rooms, the air balance can be regulated using the kitchen hood fan or the chimney extractor.

Component	Air volume	Room temperature
Supply air (ao1)	100% = \dot{V}_{max}	100% = \dot{V}_{max}
Extract air (ao2)	0% = \dot{V}_{min}	0% = \dot{V}_{min}
Heating valve (ao3)	No function	Control mode

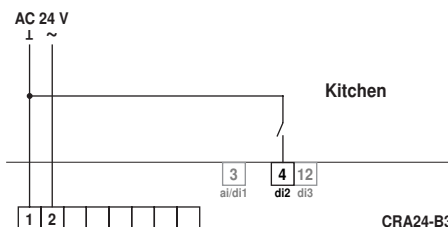
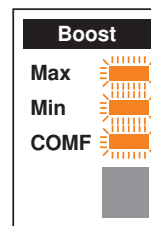

Priority 3: Bathroom (di3)

In order to remove humid air or odours from the house, the VAV controllers / air dampers can be switched to the maximum volumetric flow, for example, via the light switch in the bathroom or a humidistat.

Component	Air volume	Room temperature
Supply air (ao1)	100% = \dot{V}_{max}	100% = \dot{V}_{max}
Extract air (ao2)	100% = \dot{V}_{max}	100% = \dot{V}_{max}
Heating valve (ao3)	No function	Control mode

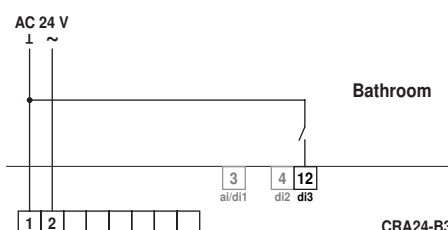
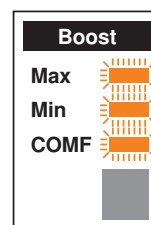

Override functions

(continued)

Priority 4: Energy hold off (di1)

In order to prevent undesired energy consumption in the event of long periods of absence, the VAV controllers / air dampers are closed and the heating unit is operated with a reduced setpoint.

Component	Air volume	Room temperature
Supply air (ao1)	CLOSED	CLOSED
Extract air (ao2)	CLOSED	CLOSED
Heating valve (ao3)	No function	Reduced control mode (setpoint – 2K offset)

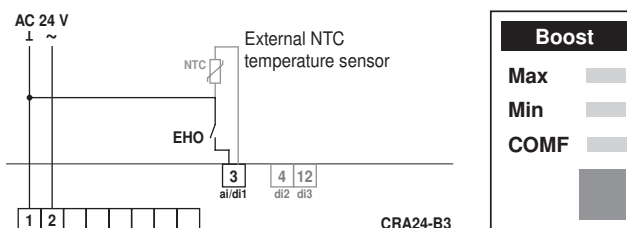

Forced ventilation
Holiday mode

During the energy hold off, the system is switched on for 30 minutes three times a day. The start times are calculated by CRA24-B3 and cannot be changed.

Component	Air volume	Room temperature
Supply air (ao1)	100% = \dot{V}_{max}	100% = \dot{V}_{max}
Extract air (ao2)	100% = \dot{V}_{max}	100% = \dot{V}_{max}
Heating valve (ao3)	No function	Reduced control mode (setpoint – 2K offset)

Maximum temperature monitoring



The room temperature can be monitored to a maximum value of 28°C. This function must be enabled via DIP switch 5 = ON.

Component	Air volume	Room temperature
Supply air (ao1)	100% = \dot{V}_{max}	100% = \dot{V}_{max}
Extract air (ao2)	100% = \dot{V}_{max}	100% = \dot{V}_{max}
Heating valve (ao3)	No function	CLOSED

External temperature sensor (ai1)

An external NTC temperature sensor can be connected at analogue input ai1. Sensor type: NTC 5k (5 kΩ) e.g. Belimo TFK.

Typical applications

- Temperature measurement in the exhaust air duct for recording the average room temperature.
- More flexible positioning of the sensor for recording the room temperature

Note:

- The controller detects the connection of an external sensor automatically. Additional settings are not required.
- The simultaneous use of an energy hold off switch at di1 is possible, although the system switches over to the internal sensor in such cases (see also "Energy hold off"). This means that the current room temperature is monitored for building protection.

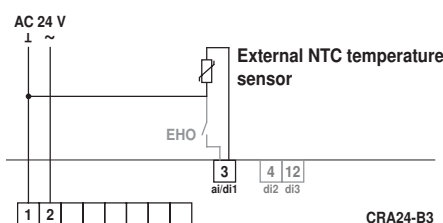

Analogue outputs

VAV controller connection

Due to the override function, it is mandatory that the supply and exhaust air control devices be connected as follows:

- Supply air: System output "ao1" (terminal 6), diagnostic connection "U5 / 1" (terminal 7)
- Exhaust air: System output "ao2" (terminal 11), diagnostic connection "U5 / 2" (terminal 8)

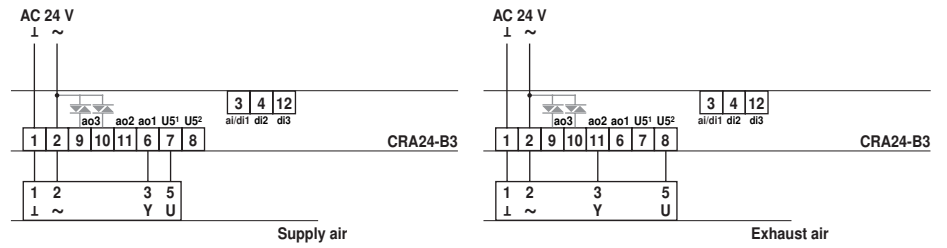

Heating valve connection

Heating valves can be controlled using a 2-point or a 3-point actuator. This selection is made using DIP switch 6. OFF = 2-point (thermo) / ON = 3-point

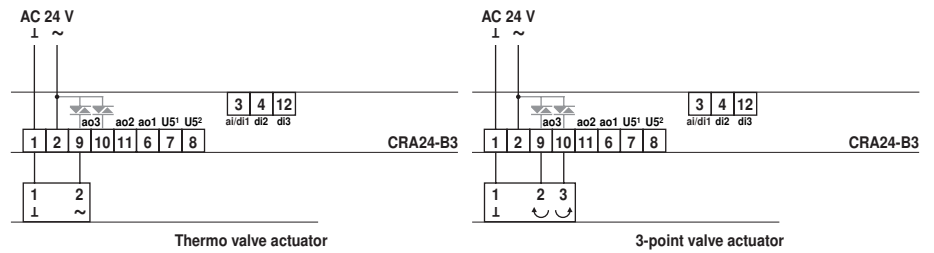

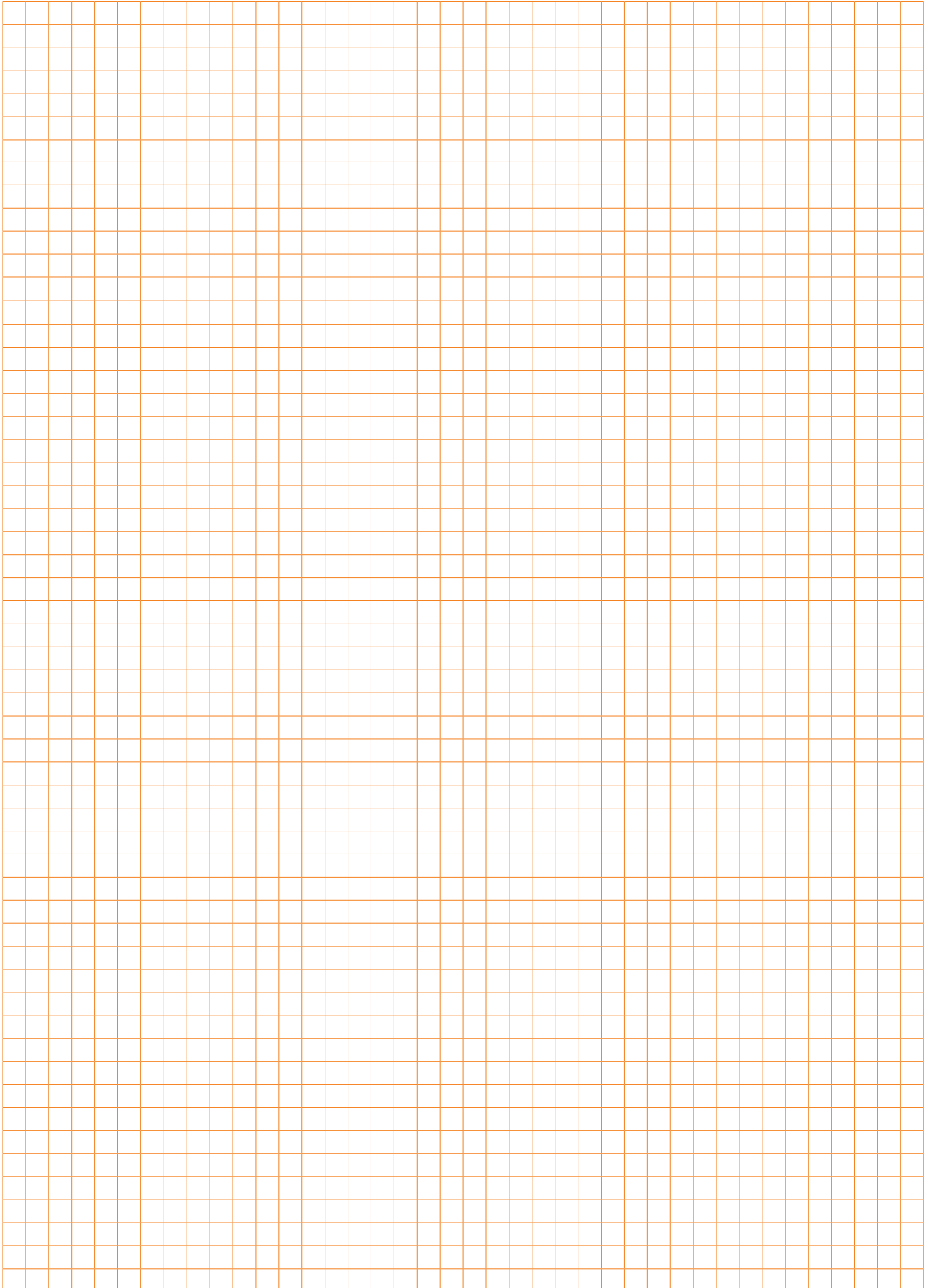

3-step switch for controlled apartment ventilation with one output:

- Analogue output ao1: Supply air/exhaust air device
 - VAV unit or damper actuator

Technical data

Electrical data	Nominal voltage	AC 24V 50/60 Hz
	Dimensioning	2 VA, without actuators
	Power supply range	AC 19.2...28.8V
Functional data	Connections	Terminal block 1 ... 3: 2.5 mm ²
	Operating	
	– Mode switch and status display (LED)	COMF (green) – MIN (orange) – MAX (red)
Output	– Hidden rotary knob for setpoint adjustment	30...70% air
	1x analogue	
Norms and Standards	– VAV system output (ao1)	2...10V, max. 5 mA
	Protection class	III Safety extra-low voltage
Dimensions / weight	Degree of protection	IP30 (EN 60529)
	Mode of operation	Type 1 (EN60730-1)
	EMC	CE according to 2004/108/EC
	Ambient conditions	
	– Operation	0...+50°C / 20... 90% r.h. (non-condensing)
	– Transport and storage	–25...+70°C / 20...90% r.h. (non-condensing)
	Weight	105 g
Housing colours	Dimensions (H x W x D)	99 x 84 x 32 mm
	Baseplate	105 g
Housing colours	Cover	NCS2005-R80B-light grey (corresponds approx. to RAL 7035)
		RAL 9003 Signal white

Safety notes



- The controller is not allowed to be used outside the specified field of application, especially not in aircraft or in any other airborne means of transport.
- It may only be installed by suitably trained personnel. Legal regulations and regulations issued by authorities must be observed during installation.
- The device does not contain any parts that can be replaced or repaired by the user.
- The device contains electrical and electronic components and is not allowed to be disposed of as household refuse. All locally valid regulations and requirements must be observed.

Product features

- Air volume control** The air volume can be pre-selected and set to minimum, variable (dial: 30 ... 70%) and maximum using the push-button and the hidden rotary knob under the controller front. This is especially suitable for applications requiring a defined air exchange.

Electrical installation
Wiring diagram
Notes

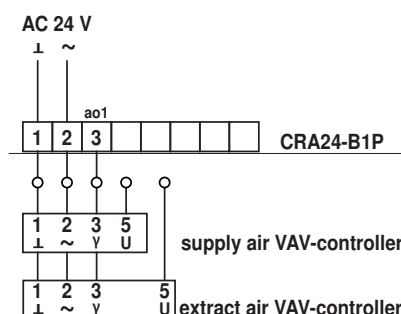
- Connection via safety isolating transformer.
- Parallel connection of other actuators possible. Note the performance data.



Operation level 1 – Operation

Operating mode / Setpoint

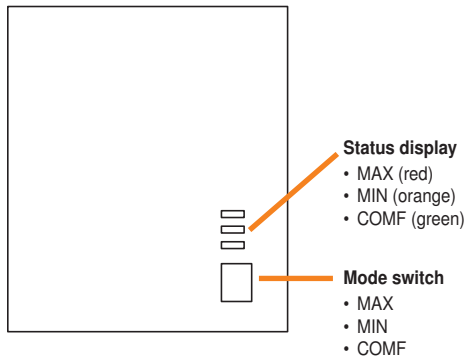
**Mode switch and status display**

One of three operating modes can be selected:

- **COMF – Nominal ventilation**
The room is maintained at comfort zone status.
- **MIN – Reduced ventilation**
The air volume is regulated to the minimum value that is set at the VAV controller.
Advantages: Energy saving mode during short absences.
- **MAX – Intensive ventilation**
The air volume is regulated to the maximum value that is set at the VAV controller.
Advantages: Maximum air exchange, e.g. during a party or fondue evening.

Operation level 2 – Configuration

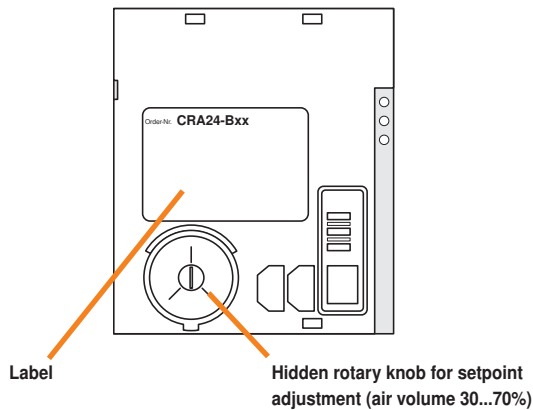

Operation level 3 – Service

Test

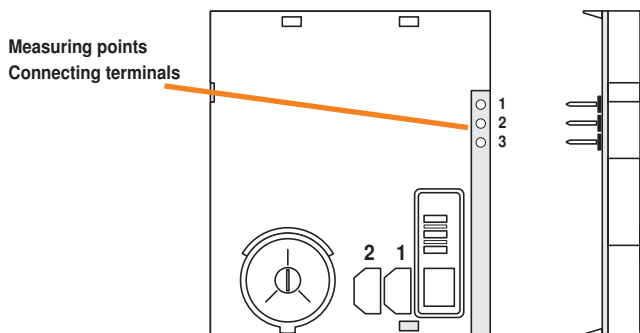
**Connecting terminals measuring points**

Measuring points for all connection terminals (also during operation).

Introduction

The CRA24-B1P is a 3-step switch without control functions or overrides. The various operating modes are set by pressing the button on the front. The corresponding functions are described in detail in the following.

Function overview

Supply	AC 24V / 50/60 Hz
Application	– Air volume control in the comfort zone
Operation	– Mode selection switch: COMF – MIN – MAX – Mode indication LED: COMF – MIN – MAX – Hidden rotary knob for setpoint adjustment: 30...70% air
1 output	– 2...10V system output: Belimo VAV controller, damper actuator
Functions	– Air volume control
Installation	Surface mounting with flush-mounted or surface-mounted connection

Air volume control

The air volume can be pre-selected and set to minimum, variable (dial: 30 ... 70%) and maximum using the push-button and the rotary knob under the controller front. This is especially suitable for applications requiring a defined air exchange.

Settings with ZTH-GEN

The operating volumetric flow setting \dot{V}_{min} / \dot{V}_{max} of the VAV controllers can be modified/checked with the help of the ZTH-GEN.

Application with damper actuator instead of VAV controllers

Use of damper actuators is usually possible but it must still be taken into account that this application cannot detect and regulate pressure changes in the air duct system (pre-pressure-dependent operation).

Note

The MIN / MAX levels **cannot** be changed when using an -SR standard actuator (mode 0 ... 10V), e.g. LM24A-SR!

Type: LM24A-MF / NM24A-MF

The MIN/MAX levels of the MF actuator can be programmed with the ZTH-GEN service tool or the Belimo PC-Tool and then be loaded in L/NM24A-MF.

Operating mode COMF (nominal ventilation)	Operating mode MIN (reduced ventilation)	Operating mode MAX (intensive ventilation)
<ul style="list-style-type: none"> The air volume can be set in the range of 30...70% of the operating volume current range $\dot{V}_{min...max}$ programmed on the VAV controller. Setting of the VAV controller (example): <ul style="list-style-type: none"> – \dot{V}_{min} 50 m³/h – \dot{V}_{max} 100 m³/h – Setting range of the rotary knob: 65...85 m³/h Air volume setting: <ul style="list-style-type: none"> – CRA24-B1P → Potentiometer under the front cover 	<ul style="list-style-type: none"> The connected VAV units are set to the minimum air volume (\dot{V}_{min}) selected on the controller. 	<ul style="list-style-type: none"> The connected VAV units are set to the maximum air volume (\dot{V}_{max}) selected on the controller.

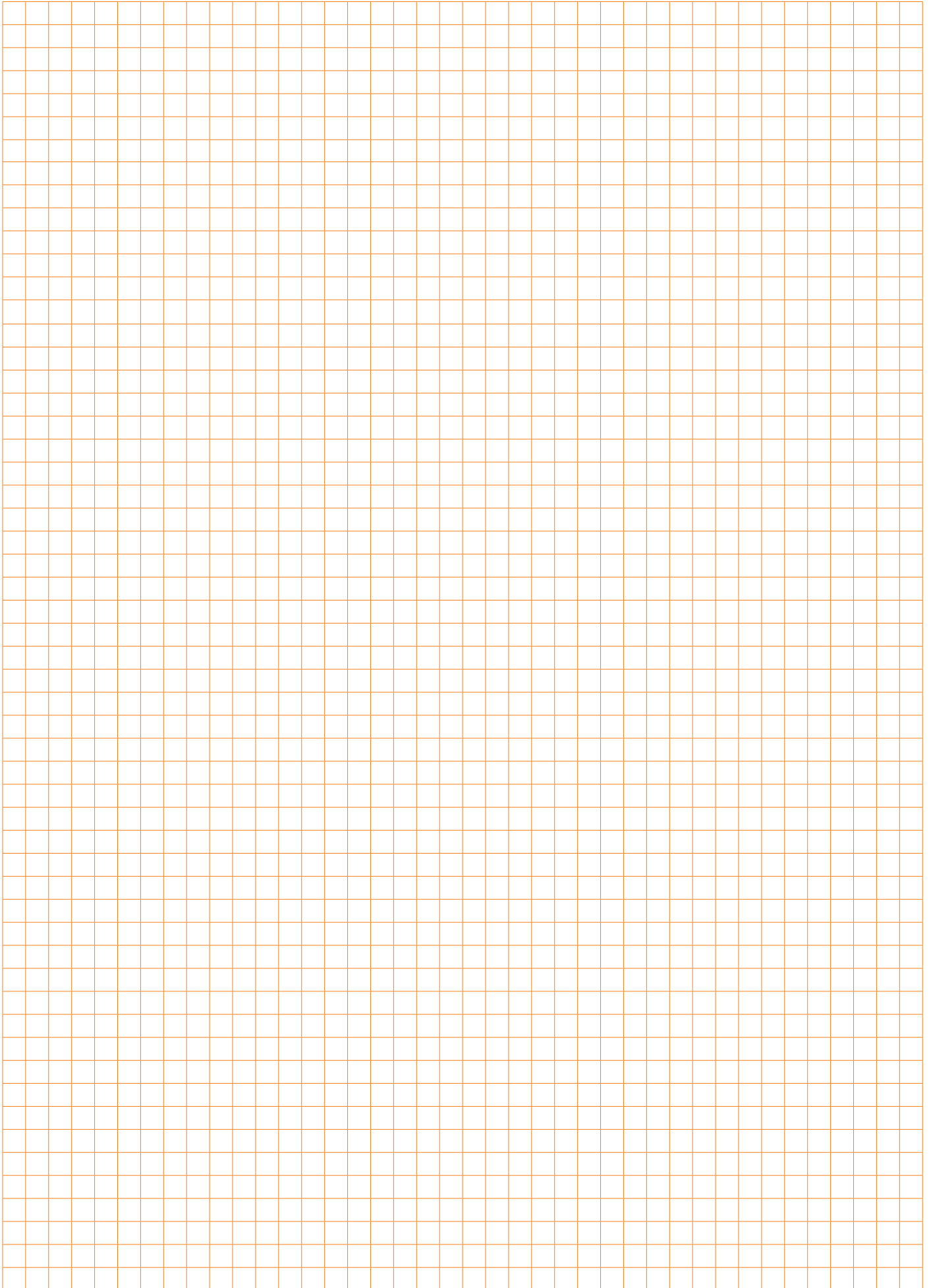

Dimensions [mm]

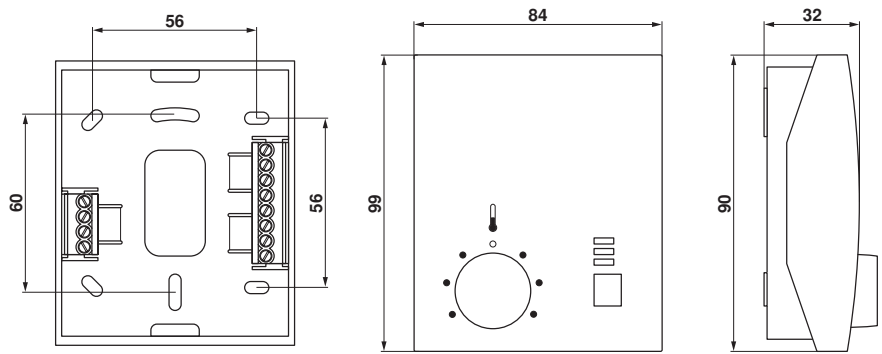

Mechanical installation

1. Remove the housing cover.
2. Pull the wall of the housing slightly outward.
3. Remove the PCB.

Rotary knob for setpoint adjustment

If the rotary knob has been removed and must be remounted, proceed as follows:

- a. Insert the rotary knob approximately half way and turn it clockwise as far as the end stop.
- b. Remove the rotary knob and align it so that the cam is flush with the left-hand end stop.
- c. Insert the rotary knob all the way.

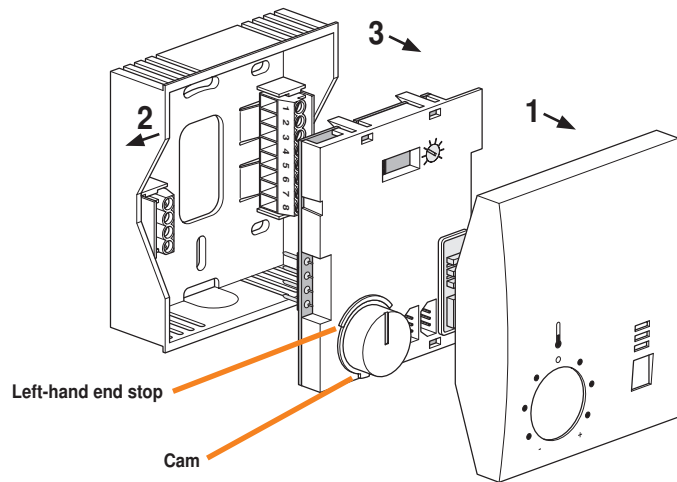

Electrical installation

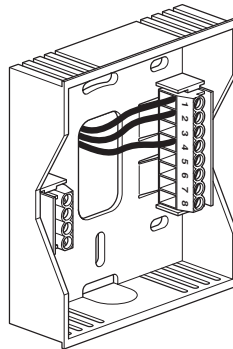

Flush-mounted connection

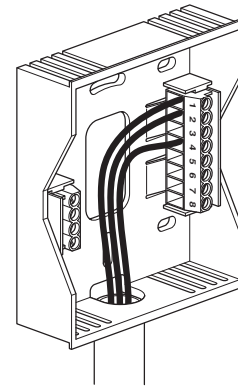

Surface-mounted connection

Notes

The number of terminals and their allocation may differ, depending on the model.

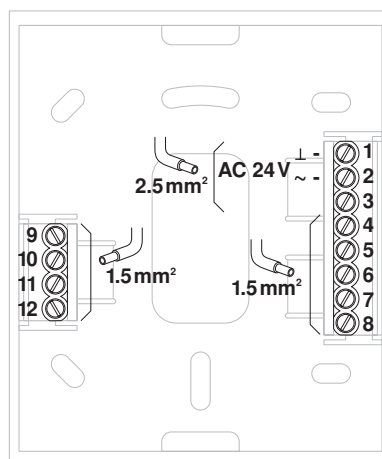

Terminal connection 1 ... 12

Power supply design / wire sizing

	In addition to the actual wire sizing, attention must also be paid to the surrounding area and the cable routing. Signal cables must not be laid in the vicinity of load cables, objects liable to cause EMC interference. etc. Paired or layer stranded cables enhance interference resistance.
24V supply Wire sizing and cabling	<p>The wire sizing and installation of the AC 24V supply, the fuse protection, and the cables are dependent on the total operated load and local regulations.</p> <p>Account must be taken of the following performance data, including starting currents:</p> <ul style="list-style-type: none"> – Wire sizing values for room temperature controllers, 3 VA per CRA24-B3 / 2 VA per CRA24-B1P – Wire sizing values for control devices, VAV controllers, damper actuators, valves, etc. can be found in the latest data sheets and product information (www.belimo.com) – Other devices to be operated with the AC 24V supply – Reserve capacity for subsequent expansion (if planned)
Analogue input connection ai1 CRA24-B3(P)	<p>The analogue input ai1 is used to connect an external NTC 5 kΩ temperature sensor. The sensor value is 5969 Ω at 21 °C. A change of 50 Ω corresponds to approximately 0.2 K in this range.</p> <p>The sensor cable constitutes a series resistance that must be added to the actual sensor value. Assuming a cable length of 15 m (2 x 15 = 30 m), the resistance of one 0.75 mm² Cu cable is approximately 0.7 Ω, in other words negligible.</p> <p>To prevent interference, however, the sensor cable should be no more than maximum of 20 m in length.</p>

Commissioning / Power on behaviour

Commissioning	<ol style="list-style-type: none"> 1. Assemble the baseplate of the housing and connect the cables (see page 21) 2. Configure the DIP switches on the printed circuit board according to the required application. 3. Assemble the printed circuit board on the baseplate of the housing and then mount the housing cover (see page 21) 4. Switch on the AC 24V nominal voltage 5. Optional: start the test and simulation mode (see below) <p>When the voltage is applied, the system starts operating normally in AUTO mode unless the test and simulation mode has been started. The active operating status is determined primarily by the configuration of the DIP switches and the status of the inputs.</p>
Power On behaviour	<p>After power on of the voltage supply the output gets initialised as follows:</p> <ul style="list-style-type: none"> – ao1 = 0V – ao2 = 0V – ao3 = Closed (200 s) <p>Subsequently the controller switches automatically to the control mode.</p>

Test and simulation mode - CRA24-B3(P)

	<p>All controllers are supplied with two auxiliary programs for commissioning and servicing:</p> <ul style="list-style-type: none"> – Internal function test – Control sequence simulation
Activating test and simulation mode	<p>The test and simulation mode of CRA24-B3 controllers can be activated easily with the mode switch on the user interface.</p> <p>To activate function test</p> <ol style="list-style-type: none"> 1. Set the mode switch to MAX <ul style="list-style-type: none"> – The red LED (MAX status indication) lights up 2. Keep the mode switch pressed for ten seconds <ul style="list-style-type: none"> – The internal function test is activated (see below) <p>To activate control sequence simulation</p> <ol style="list-style-type: none"> 3. Press the mode switch again briefly for approx. one second <ul style="list-style-type: none"> – The green LED (COMF status indication) flashes – Control sequence simulation is activated (see below)
Deactivating test and simulation mode	<p>The test and simulation mode can be deactivated either by pressing the mode switch again for ten seconds or by interrupting the power supply. It also deactivates itself automatically 15 minutes after the last user action (auto-reset).</p>

Internal function test - CRA24-B3(P)

The internal function test enables an inspection of the nominal voltage that is connected to the controller (AC 24 V), i.e. the complete installation from the control cabinet to the controller. The three LEDs (status display) display the voltage level (see below) and statuses during the test.

Nominal voltage (AC 24V)

LED (status indication)	Scenario A	Scenario B	Scenario C
MAX red	flashes	flashes	permanently on
MIN orange	flashes	flashes	permanently on
COMF green	permanently off	flashes	permanently on
	<20 V	20 ... 22 V	>22 V

Note

Case B and C do not need further attention. In case A (<20 V) attention must be paid to the following points :
 – Quality of the cabling and connections
 – Cable length and diameter and transformer design

Control sequence simulation - CRA24-B3(P)

In simulation mode, the connected actuators can be operated regardless of the room temperature. The air volume (\dot{V}_{min} and \dot{V}_{max}) in the air systems and the maximum heating capacity in the water systems can thus be checked.

Notes

- The external control signals (di1, di2 and di3) are suppressed during the simulation.
- The potentiometer may be adjusted only slowly, due to the system-dependent attenuation of the setpoint potentiometer in simulation mode.
- In the case of the CRA24-B3P controller, do not forget to reset the potentiometer to the original position after the simulation.
- The simulation mode automatically ends 15 minutes after the last manipulation (auto-reset).

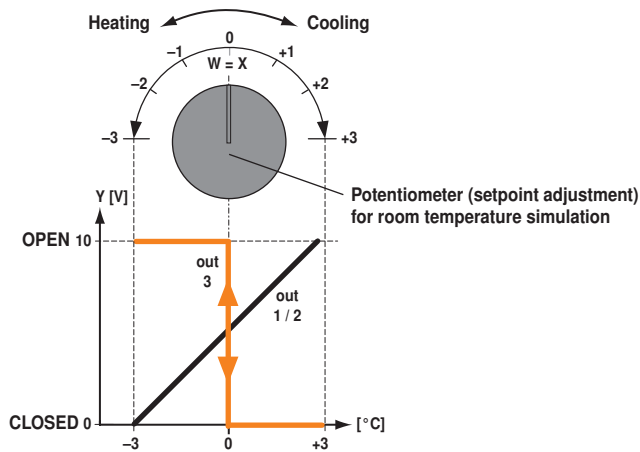

Checking and setting the VAV controllers

The connected VAV controller is controlled and adjusted with either the ZTH-GEN Service tool or the Belimo PC-Tool. The connection to the ZK1-VAV cable is established via the two diagnostic sockets under the front cover of CRA24-B3(P).

All inclusive



5 years
Guarantee



Worldwide present



Complete
assortment from
a single source



Examined
Quality



Short
delivery time



Comprehensive
support

Belimo Europa

BELIMO Automation AG

Brunnenbachstrasse 1
CH-8340 Hinwil

Tel. +41 43 843 61 11

Fax. +41 43 843 62 68

info@belimo.ch

www.belimo.ch