

Table of Contents

SAFETY INSTRUCTION	3
Safety Symbols	3
General Introduction	4
AC Input	4
Fuse Parameters	4
OVERVIEW	5
Models Introduction	5
Main Characteristics	5
Front and Rear Panel Overview	6
FRONT PANEL INTRODUCTION	6
Panel Overview	6
Display	6
Status Indication	6
Storage Indication	7
Brief Introduction of Panel Buttons	7
REAR PANEL INTRODUCTION	9
OPERATION	10
Power Up	10
Output ON/OFF	11
Beep ON/OFF	11
Panel Lock	11
Output Parameters Setup	12
Save Setup	12
Recall Setup	13

**Digital-Control and Programmable
DC Power Supply**

KA3000/6000-Series User Manual

REMOTE CONTROL.....	14
Remote Control Setup.....	14
Remote control procedures.....	15
FAQ.....	16
SPECIFICATIONS.....	17

SAFETY SYMBOLS

This chapter contains important safety instructions that you must follow when operating the KA3000 & KA6000 series and when keeping it in storage. Read the following before any operation to insure your safety and to keep the best condition for the KA3000 & KA6000 series.

Safety Symbols

These safety symbols may appear in this manual or on the series.



WARNING



DANGER High Voltage.



Earth (ground) Terminal

SAFETY INSTRUCTION

Safety Guidelines

- Do not block or obstruct the cooling fan vent opening.
- Avoid severe impacts or rough handling that leads to damage.
- Do not discharge static electricity .
- Do not disassemble unless you are qualified as service personnel.

AC INPUT



- AC Inut Voltage: 110V / 120V / 220V / 230V , 50 / 60 Hz
- Connect the protective grounding conductor of the AC power cord to an earth ground, to avoid electrical shock.

Operation Environment

- Location: Indoor, no direct sunlight, dust free, almost non-conductive pollution (note below)
- Relative Humidity: < 80%
- Altitude: < 2000m
- Temperature: 32-104°F

Storage environment

- Location: Indoor
- Relative Humidity: < 70%
- Temperature:

FUSE



Model	110V/120V	220V/230V
KA3003D/P	T4A/250V	T2A/250V
KA3005D/P	T5A/250V	T3A/250V
KA6002D/P	T5A/250V	T3A/250V

- To ensure fire protection, replace the fuse only with thespecified type and rating.
- Disconnect the power cord before fuse replacement.
- Make sure the cause of fuse blowout is fixed before fuse replacement.

Series Lineup/Main Features

Model	V Meter	A Meter	USB	Resolution
KA3003D	4digit	4digit	NO	10mV/1mA
KA3005D	4digit	4digit	NO	10mV/1mA
KA6002D	4digit	4digit	NO	10mV/1mA
KA3003P	4digit	4digit	Yes	10mV/1mA
KA3005P	4digit	4digit	Yes	10mV/1mA
KA6002P	4digit	4digit	Yes	10mV/1mA

Main Features

- Performance**
 - Low noise: cooling fan controlled by heatsink temperature;
 - Compact size, light weight.
- Operation**
 - Constant voltage / constant current operation
 - Output On / Off Control
 - Digital panel control
 - 4 pairs of panel setup save / recall
 - Coarse and fine Voltage / Current control
 - Software calibration
 - Beep output
 - button lock function
- Protection**
 - Overload protection
 - Reverse polarity protection
- Interfaces**
 - USb/RS232 for remote control (onely For KA3003P,KA3005P,KA6003P)

Front Panel Overview

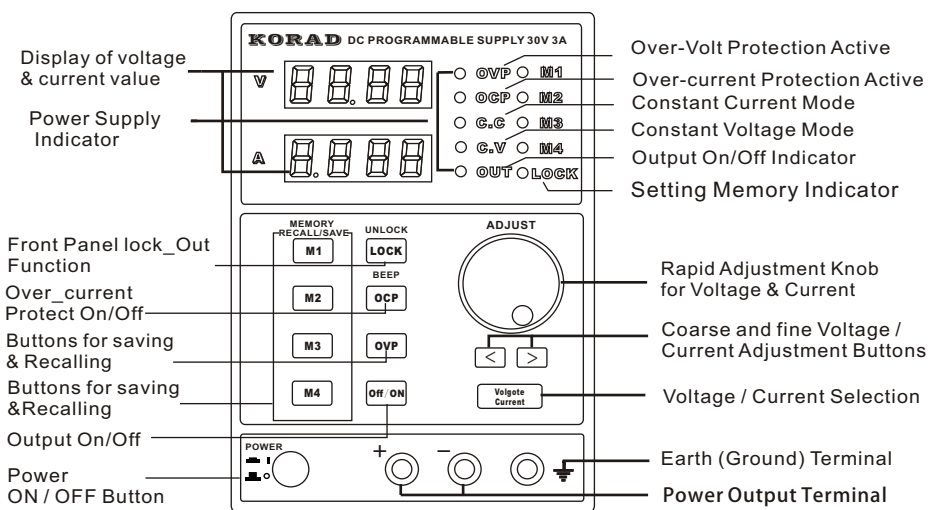

DISPLAY

Voltage level **v**  Voltmeter displays the setup value of output voltage .

Current level **A**  Displays the setup value of output current .

Condition Indication

- **⓪VP** OVP is the indicator of overvoltage protection. When overvoltage function is turned on, ● **⓪VP** indicator lights on; when output voltage is higher than protection setup value due to unexpected conditions, output cuts off and OVP indicator flickers; Press the button OVP again, and the power supply recovers.

- **⓪CP** OCP is OCP indicator. When overcurrent function is turned on, ○ **⓪CP** indicator lights on.
- **Ⓒ.Ⓒ** C.C is constant current indicator. When power supply is in the mode of constant current, this light is on.
- **Ⓒ.V** C.V is constant voltage indicator. When power supply is in the mode of constant voltage, this light is on.
- **⓪UT** OUT is output indicator. If light on, there is voltage output in the output terminal.

Storage Indication

- **M1**
- **M2** Indication of saving and recalling 5 setups stored internally;
- **M3** When LOCK indication turns on, the front panel button
- **M4** operation is locked.
- **LOCK**

Brief Introduction of Panel Operation

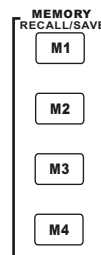

Saves or recalls panel settings. For settings, 1 ~ 4 are available. For save / recall details, see Page 13.

UNLOCK

LOCK — Front panel lock_out function. For details, see Page 11.

BEEP

OCP — Over-Current protect on/off, . Pressing this button for more than 2 seconds will make beep ON On/OFF.

OVP — Over-voltage Protect On/Off

Off / ON — Output On/Off.

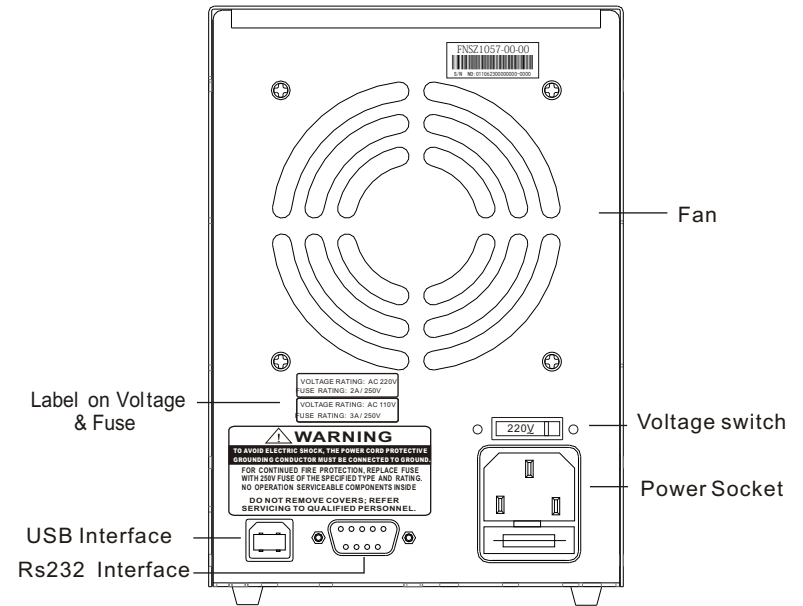
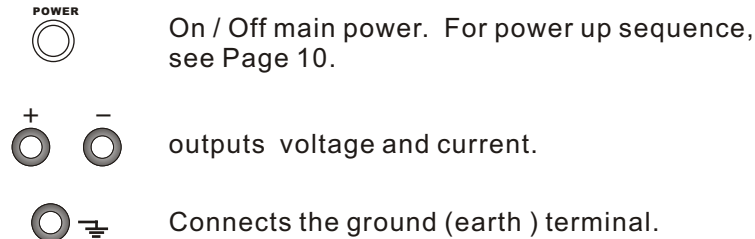
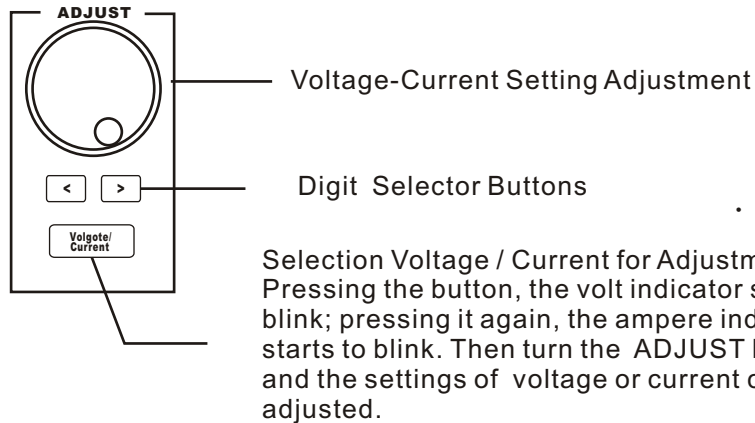

RS232 dependent interface based on remote control order (see Page 14); only for KAXXXX series, such as KA3003 P and so on.

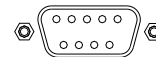

RS232 dependent interface based on remote control order (see Page 14); only for KAXXXX series, such as KA3003P and so on.

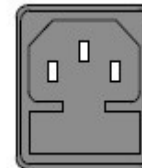

The power cord socket mainly accepts AC values: 115V / 230V, 50 / 60 Hz. Please refer to the fuse parameters on the back fuse label to replace the specified fuse.



Make sure the correct type of fuse is installed before power up

OPERATION

Connect AC power cord

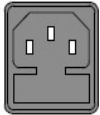

Connecting AC power cord and selecting the corresponding AC voltage according to the back label on voltage; then connecting the AC power cord to the socket on the back panel

power on



Press the power switch to turn power on. The display initializes, showing the model of the machine and then showing the setting last.

power off



Press the power switch again to turn power off.

Output On / Off

Panel Operation

Press the Output button to turn on output; and the button LED also turns on. Pressing the Output button again to turn off the output and the LED.

Note: If there are any of the following conditions, the output will automatically turn off.

1. OVP turns on and there are unusual OVP on the output terminal.
2. The setting voltage is more than that of the OVP.
3. Recalling other setups from the memory.

Beep On / Off

Panel Operation

By default, the beep sound is enabled. To turn off the beep, press the OCP(BEEP) button for 2 seconds. A beep comes out and the beep setting will be turned off. To enable the beep, press the OCP(BEEP) button again for 2 seconds.

Front Panel Lock

Panel operation

Press the LOCK button to lock the front panel button operation. The LED turns on. To unlock, press the LOCK button for 2 seconds.

Output Set

Panel operation

1. Connecting the load to the front port, red (+), black (-).
2. Setting output voltage and current.
Press the button Voltage/Current selection to switch voltage adjustment and current adjustment. Adjusting voltage and current with Voltage / Current Adjustment knob. By default, the Voltage and Current knob work in the coarse mode. To activate the fine mode, press the buttons to select the coarse mode or the fine mode.
3. Turning on the output and pressing the output button.
The button LED turns on and displays CV or CC mode.

SAVE / RECALL SETUP

Save Setup

Background	The front panel settings can be stored into one of the four internal memories.
Contents	<p>The following list shows the setup contents.</p> <ul style="list-style-type: none"> ● Fine / coarse knob editing mode ● Beep on / off ● Output voltage / current level <p>The following settings are always saved as "off".</p> <ul style="list-style-type: none"> ● Output on / off ● Front panel lock on / off
Panel operation	Press one of the 1 ~ 4 Memory buttons for 2 seconds, for example number 1. The panel settings are saved in memory No. 1 and the button LED turns on. When the panel settings are modified, the LED turns off.

Recall Setup

The front panel settings can be recalled from one of the four internal memories.



Recalls panel settings. For settings, 1 ~ 4 are available.

- M1 Indication of saving and recalling 4 setups stored internally;
- M2
- M3 Press one of the 1 ~ 4 Memory buttons, for example number 1. The panel settings saved in memory No. 1 are recalled. The LED M1 turns on.
- M4

Note: When a setting is recalled, the output automatically turns off.

REMOTE CONTROL

Remote Control Setup

All the models with the suffix "P", such as KA3003P, KA3005P, KA6002P, etc. can be connected to the PC through interfaces USB/RS232 on the back of the machine and controlled by the remote control.

COM setting Set up the COM port inside the PC according to the following list.

- Baud rate: 9600
- Parity bit: None
- Data bit: 8
- Stop bit: 1
- Data flow control: None

Functionality check Run this query command via the terminal application such as MTTY (Multi-threaded TTY).
*DIN?
This should return the identification information:
Manufacturer, model name, serial number.
KA3003、SN: xxxxxxxx、 Vx.xx

REMOTE CONTROL PROCEDURES

Entering the Remote Control Mode

1. Connect the USB cable.
2. The power supply will automatically connect. After normal connection, there will be a tweet from the power supply itself.
3. The panel buttons are locked, so the power supply can only be controlled by the computer.

NOTE: KORAD software must be installed first.

Exiting from the Remote Control Mode

1. Close the remote control software.
2. Disconnect USB from the back.
3. The power supply disconnects; a tweet from the beep with the hint that the remote control is over.
4. The power supply automatically comes into the panel control mode.

FAQ

Q1: The panel buttons don't work when power on.

A1: The panel is locked. Press the button  for over 2 seconds, and then the panel will unlock.

Q2: Pressing ON/OFF, there is no output when power on.

A2: Current setup is 0.

Q3: Output voltage rises slowly when output button is on.

A3: Current setup is too small.

Q4: Making OCP on and pressing output switch; and then the output is automatically shut off.

A4: Current protection value setup is too small. You could press output switch and then make OCP on.

Specifications

Note: The specifications below are tested under the conditions of temperature 25°C±5°C and the warm-up for 20 minutes.

Models	KA3003	KA3005	KA6002
Voltage Range	0-30V	0-30V	0-60V
Current Range	0-3A	0-5A	0-2A
Load Regulation			
Voltage	≤0.01%+2mv	≤0.01%+2mv	≤0.01%+2mv
Current	≤0.1%+5mA	≤0.1%+10mA	≤0.1%+5mA
Line Regulation			
Voltage	≤0.01%+3mv	≤0.01%+3mv	≤0.01%+3mv
Current	≤0.1%+3mA	≤0.1%+3mA	≤0.1%+3mA
Setup Resolution			
Voltage	10mV	10mV	10mV
Current	1mA	1mA	1mA
Setup Accuracy (25°C±5°C)			
Voltage	≤0.5%+20mV	≤0.5%+20mV	≤0.5%+30mV
Current	≤0.5%+5mA	≤0.5%+10mA	≤0.5%+5mA
Ripple(20-20M)			
Voltage	≤1mVrms	≤2mVrms	≤1mVrms
Current	≤3mA _{rms}	≤3mA _{rms}	≤3mA _{rms}
Temp. Coefficient			
Voltage	≤100ppm+10mV	≤100ppm+10mV	≤100ppm+10mV
Current	≤100ppm+5mA	≤100ppm+5mA	≤100ppm+5mA
Read Back Accuracy			
Voltage	10mV	10mV	10mV
Current	1mA	1mA	1mA
Read Back Temp. Coefficient			
Voltage	≤100ppm+10mv	≤100ppm+10mv	≤100ppm+10mv
Current	≤100ppm+5mA	≤100ppm+5mA	≤100ppm+5mA

Reaction Time			
Voltage Rise	≤100mS	≤100mS	≤100mS
Voltage Drop	≤100mS (10% Rated load)	≤100mS (10% Rated load)	≤100mS (10% Rated load)
Interface			
Optional Interfaces (for programmable models only): RS232, USB			
Accessories			
User manual 1 PC ; Power cord 1 PC, Test lead 1 pc, software CD 1PC(only programmable units).			
Weight and Dimension			
4.3(W)*6.1(H)*10.2(D)Inches, KA3003 7.7(lbs), KA3005x 9.5(lbs)			

The proprietary information in this manual is protected by copyrights. Any photocopies, reproductions or translation to another language are not allowed unless it is permitted by KORAD Technology officially. And all rights are reserved.

The information in this manual is correct when printing. However, KORAD will continuously improve products and reserve the rights to change specifications, equipment, and maintenance procedures at any time without notice.

SHENZHEN KORAD TECHNOLOGY CO. LTD.