

RV Series Air Control Valve (5/2,5/3way)



RV

Air Control Valve (5/2,5/3)

1
RVA(5/2,5/3)

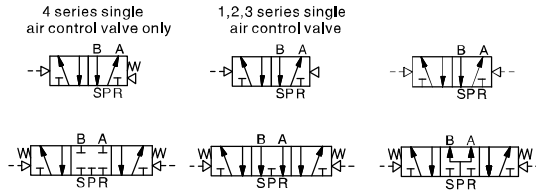

How to Order?

Series No/Ways	Positions	Valve Body ID Code	Controls	Initial Status	Port Size	Reset Type	Thread Type
RVA	5: 5 ways 2:2 positions 3:3 positions	1: 1Series 2: 2Series 3: 3Series 4: 4Series	1: Single control 2: Double control	C: Center close P: Center pressure E: Center exhaust (only for 5/3 ways)	M5: M5 06: 1/8" 08: 1/4" 10: 3/8" 15: 1/2"	Blank: Spring return (Apply to 4 series single control valve) Q: Air return (Apply to 1,2,3 series single control valve)	Bland: G P: PT T: NPT

Order Example:

RV series air control valve, 5/2 way, 2 series valve body size, single control, 1/8" port size, air return, G thread,
ERP code is: RVA5221-06Q

Specifications

Model No.	RVA5211-M5 RVA5212-M5 RVA5312-M5	RVA5211-06 RVA5212-06 RVA5312-06	RVA5221-06 RVA5222-06 RVA5322-06	RVA5221-08 RVA5222-08 RVA5322-08	RVA5231-08 RVA5232-08 RVA5332-08	RVA5231-10 RVA5232-10 RVA5332-10	RVA5241-10 RVA5242-10 RVA5342-10	RVA5241-15 RVA5242-15 RVA5342-15
Port size	M5	G1/8	G1/8	G1/4(Ex,G1/8)	G1/4	G3/8(Ex,G1/4)	G3/8	G1/2
Sectional area(mm)	5/2: 5.5(CV=0.31) 5/3: 5.5(CV=0.28)	5/2: 12(CV=0.67) 5/3: 9(CV=0.50)	5/2: 14(CV=0.78) 5/3: 12(CV=0.67)	5/2: 16(CV=0.89) 5/3: 12(CV=0.67)	5/2: 25(CV=1.40) 5/3: 18(CV=1.00)	5/2: 30(CV=1.68) 5/3: 18(CV=1.00)	5/2: 50(CV=2.79) 5/3: 30(CV=1.67)	5/2: 50(CV=2.79) 5/3: 30(CV=1.67)
Working medium	Clean air(After 40 μm filtration)							
Acting type	External type							
Reset type	Air reset				Spring reset / Air reset			
Lubrication	Not required							
Working pressure(MPa)	0.15~0.8							
Guaranteed pressure(MPa)	1.2							
Working temperature(°C)	-20~70 (No freezing)							
Max. acting frequency	5/2: 5 Cycles/s; 5/3: 3 Cycles/s							
Weight(g)	RVA5211:72 RVA5212:87 RVA5312:181		RVA5221:128 RVA5222:153 RVA5322:219		RVA5231:218 RVA5232:260 RVA5332:358		RVA5241:437 RVA5242:490 RVA5342:598	

Internal Structure

Single Air Control

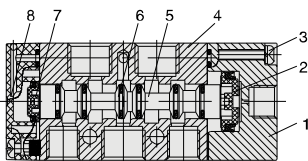

Double Air Control

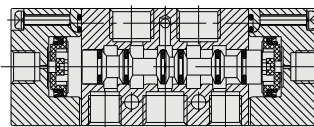

5/3 Ways Solenoid Valve

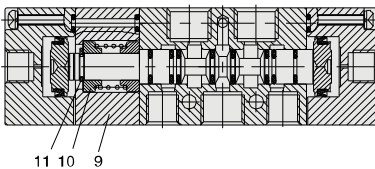

No.	Part Name	Material
1	Air Control Cover	Aluminum Alloy
2	Piston	POM
3	Screw	Carbon Steel
4	Valve Body	Aluminum Alloy
5	Spool	Aluminum Alloy
6	O-ring	NBR
7	Piston	POM
8	Rear Cover	Zinc Alloy
9	Back Seat	Aluminum Alloy
10	Spring Seat	Aluminum Alloy
11	C-type Buckle	65Mn

RV Series Air Control Valve (5/2,5/3way)



1

RVA(5/2,5/3)

Flow Chart

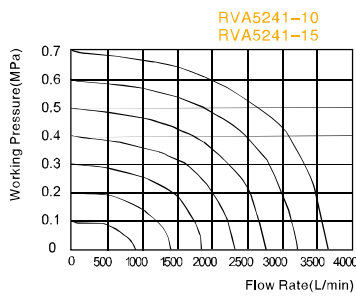
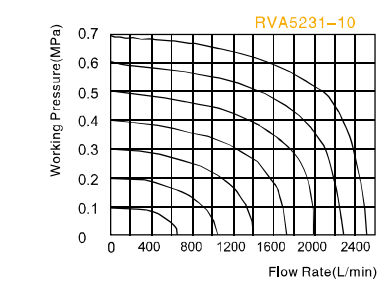
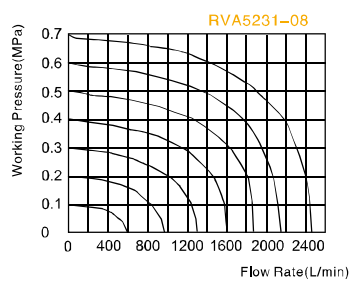
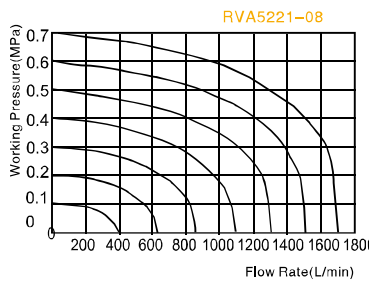
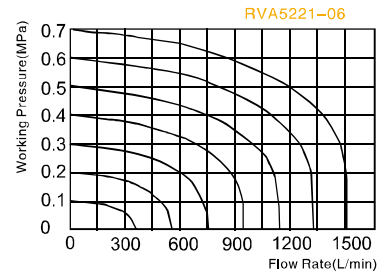
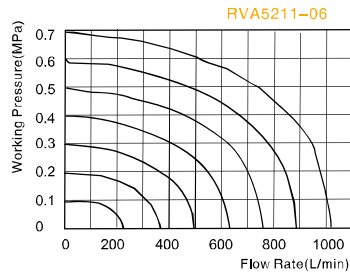
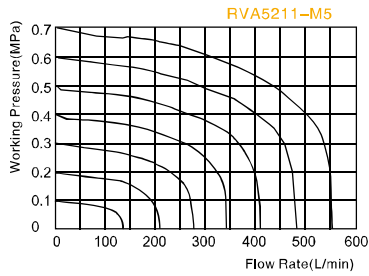

Main Dimension

Single Air Control

Double Air Control

5/3 Ways Solenoid Valve

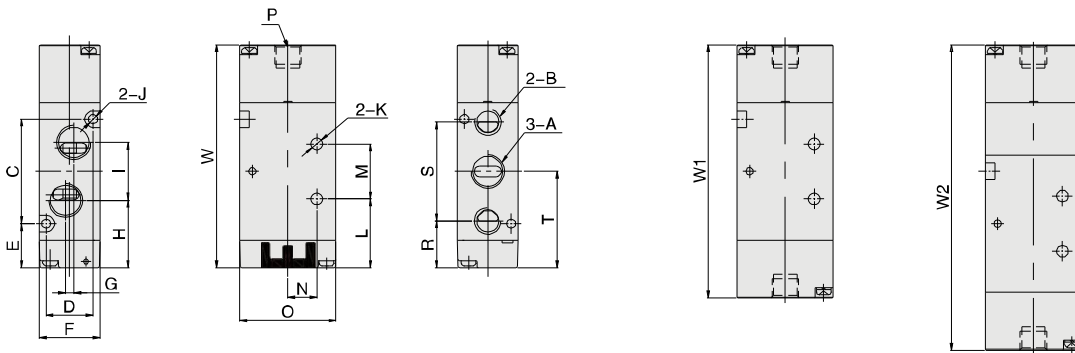

Model/Sign	A	B	C	D	E	F	G	H	I	J	K	L	M	N	O	P	R	S	T	W	W1	W2
RVA5211-M5	M5	M5	30	13	16.5	18	0	24.5	14.1	3.3	3.3	24.5	14	9.5	27	G1/8	17.9	27.2	31.5	72	81	96
RVA5211-06	G1/8	G1/8	30	13	16.5	18	3	23.5	16	3.3	3.3	24.5	14	9.5	27	G1/8	17.5	28	31.5	72	81	96
RVA5221-06	G1/8	G1/8	38	17	16	22	0	26	18	3.3	4.3	25	20	10.5	35	G1/8	17	36	35	81	92	111
RVA5221-08	G1/4	G1/8	38	17	16	22	3	24.5	21	3.3	4.3	25	20	10.5	35	G1/8	17	36	35	81	92	111
RVA5231-08	G1/4	G1/4	50	20	19.1	27	0	33.1	22	4.3	4.3	32.1	24	13.5	40	G1/8	21.6	45	44.1	99.6	111	130
RVA5231-10	G3/8	G1/4	50	20	19.1	27	4	32.1	24	4.3	4.3	32.1	24	13.5	40	G1/8	21.6	45	44.1	99.6	111	130
RVA5241-10	G3/8	G3/8	72	27	21	34	0	39	36	4.3	5.2	43	28	17.5	50	G1/8	25.5	63	57	127	140	161
RVA5241-15	G1/2	G1/2	72	27	21	34	4	39	36	4.3	5.5	43	28	17.5	50	G1/8	25.5	63	57	127	140	161