

MVSC1-150 series

SOLENOID VALVE

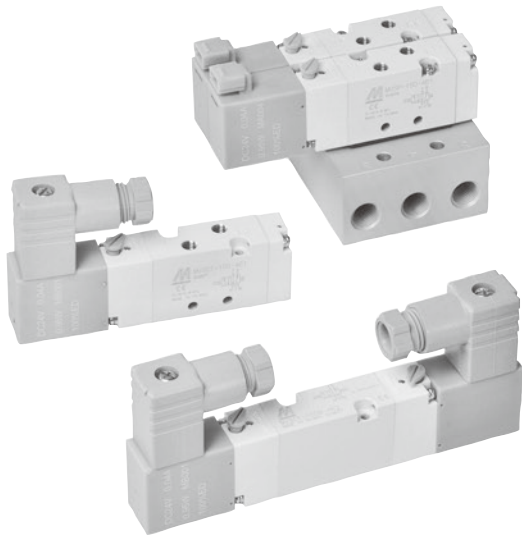

Specification

Model	4E1	4E2
Port size	M5×0.8	
No. of port	5	
No. of position	2	
Medium	Air	
Operating perssure range	0.15~0.8 MPa	
Proof pressure	1 MPa	
Effective orifice	3.8 mm ²	
Reponse time	DC < 23 ms ; AC < 35 ms	
Ambient temperature	-5~+50°C (No freezing)	
Voltage	AC110V, 220V (50/60)Hz, DC24V/12V	
Power consumption	AC=1.12VA, DC=0.95W	
Available voltage range	±10%	
Insulation class	F class	
Weight	73 g	108 g

Order example of valve

MVSC1 – 150M – 4E2 – AC110 – H1

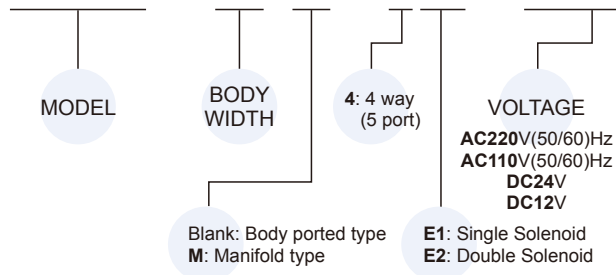

Flow features

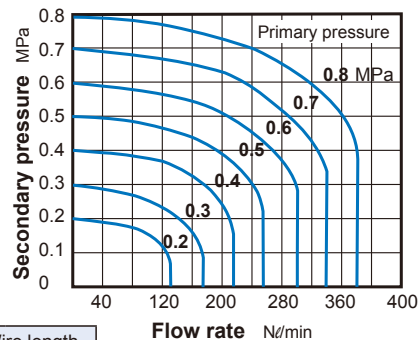

Order example of manifold

MVSC1 – 150M – 5B3 – G

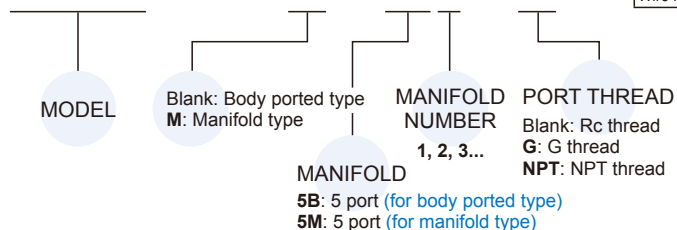

Order example of wire

MVDY – 100 – WA2J2

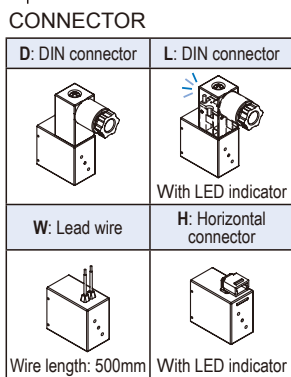
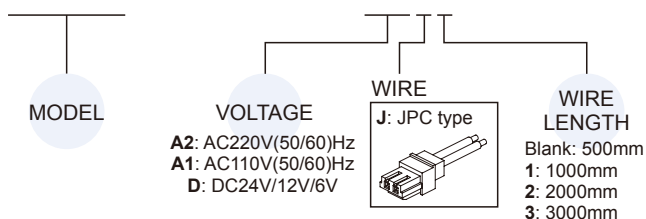

Wire length
— 500mm
1 1000mm
2 2000mm
3 3000mm

* Wire length only for "H: Horizontal connector".

Caution

Prohibit apply force to coil when tighten the tube fitting.

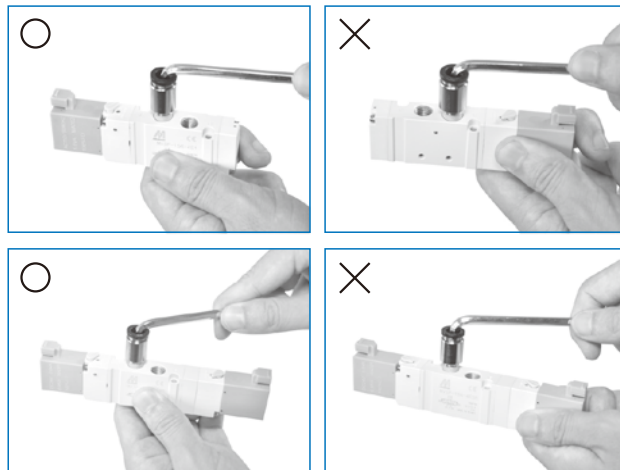

MVSC1-150 Dimensions

SOLENOID VALVE



MVSC1-150-4E1

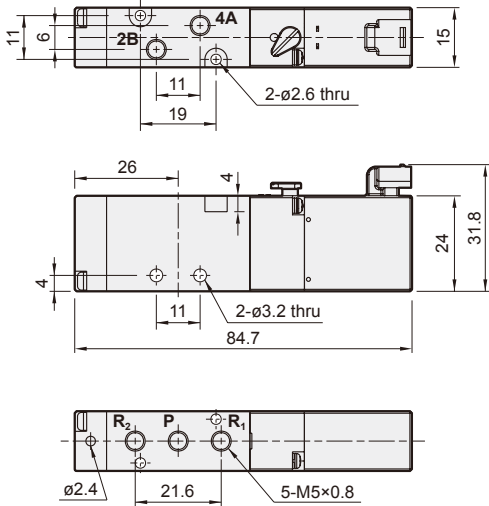
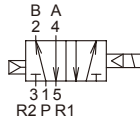

DIN connector /
DIN connector
with LED indicator

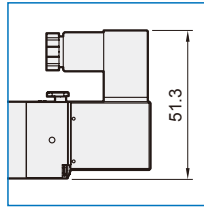

MVSC1-150-4E2

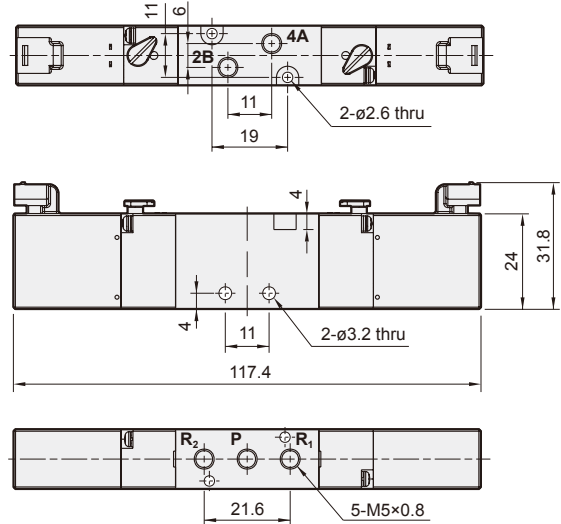
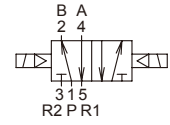

MVSC1-150-5B*

5 port (for body ported type)

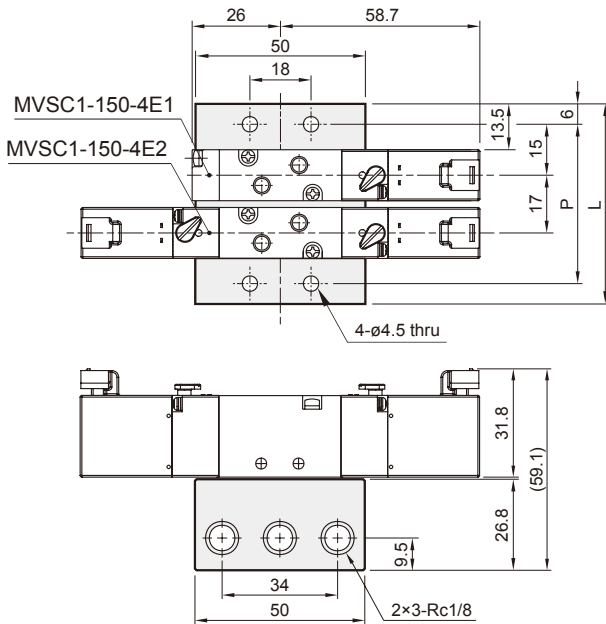

MVSC1-150M-5M*

5 port (for manifold type)

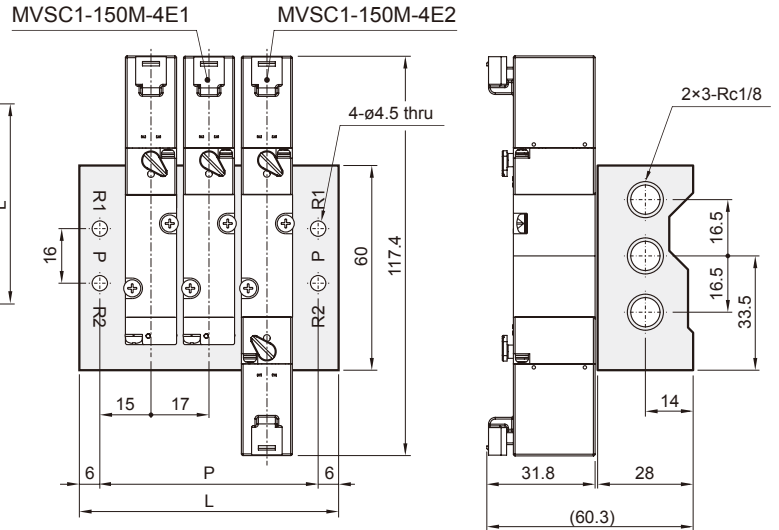

No. of stations	P	L
2	47	59
3	64	76
4	81	93
5	98	110
6	115	127
7	132	144
8	149	161
9	166	178
10	183	195

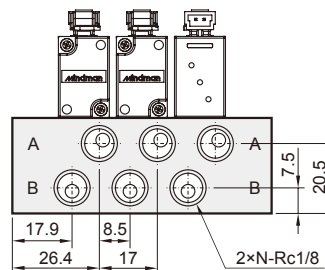

No. of stations (N)	P	L
2	47	59
3	64	76
4	81	93
5	98	110
6	115	127
7	132	144
8	149	161
9	166	178
10	183	195