

MVSC-460 series

SOLENOID VALVE

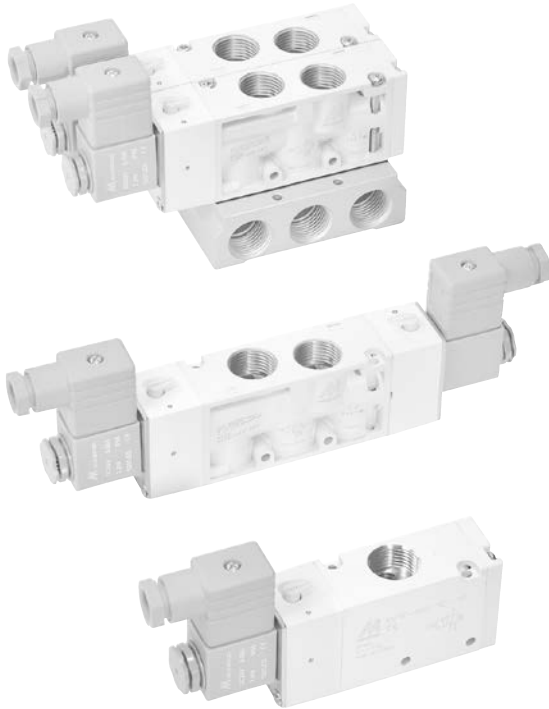

Mindman



Specification

Model	3E1	3E2	4E1	4E2	4E2 C.P.R
Bore No.	15A				
Port size	G1/2				
No. of port	3		5		
No. of position	2			3	
Medium	Air				
Operating perssure range	0.2~0.8 MPa			0.3~0.8 MPa	
Operating pressue (LP)	0~0.8 MPa				
External pilot pressure (LP)	0.2~0.8 MPa			0.3~0.8 MPa	
Proof pressure	1 MPa				
Effective orifice	60 mm ²	50 mm ²	30 mm ²		
Reponse time	50 ms				
Ambient temperature	-5~+50°C (No freezing)				
Voltage	AC110V, 220V (50/60)Hz, DC24V				
Power consumption	AC=4.8/4.4VA, 6/4.9VA, DC=2W				
Available voltage range	±10%				
Insulation class	F class				
Weight	353 g	473 g	330 g	452 g	550 g

Order example of valve

MVSC – 460 – 4E2C – NC – AC110 – L – LP – NPT

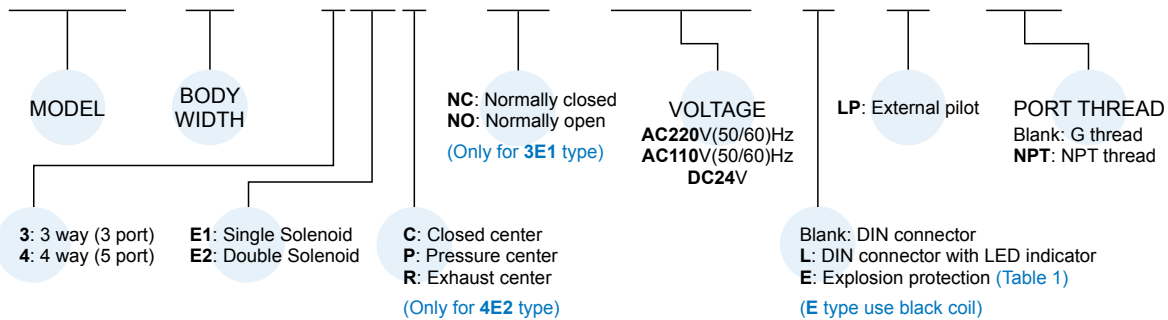

Order example of manifold

MVSC – 460 – 5B3 – NPT

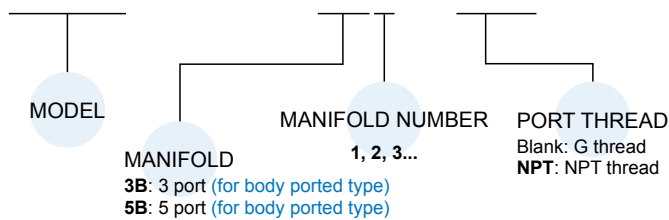

Table 1

Property for explosion-proof type

Anti-explosion class	EEx m II T4
Voltage	AC110V, 220V,(50/60)Hz, DC24V.
Power consumption	AC=4.4VA DC=5W
Available voltage range	±10%
Insulation class	F class
Wire length	3 m

MVSC-460 Dimensions

SOLENOID VALVE



MVSC-460-4E1

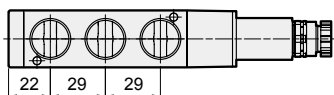
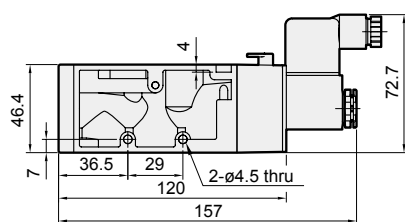
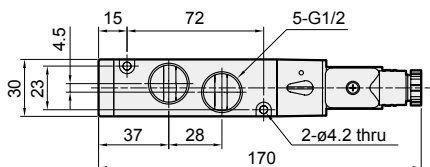
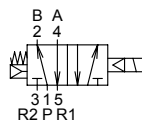

MVSC-460-4E2

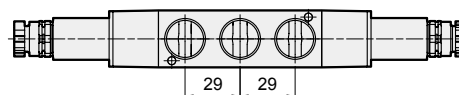
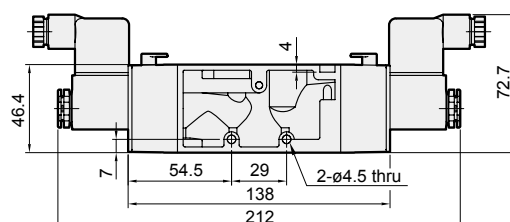
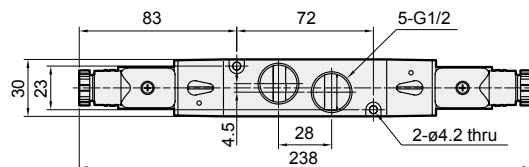
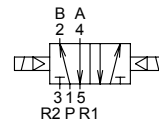

MVSC-460-4E2C.P.R

MVSC-460-4E2C

MVSC-460-4E2P

MVSC-460-4E2R

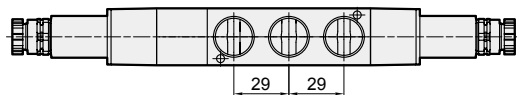
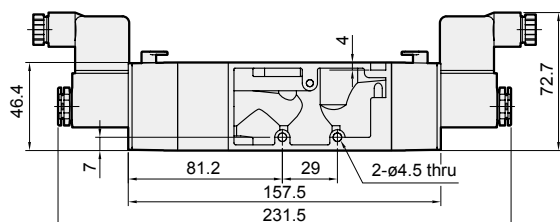
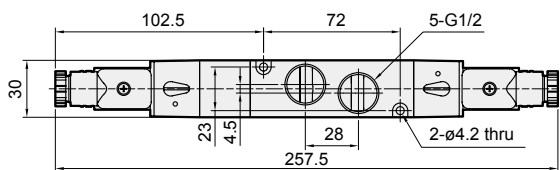
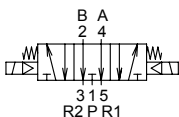
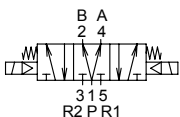
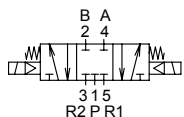

LP

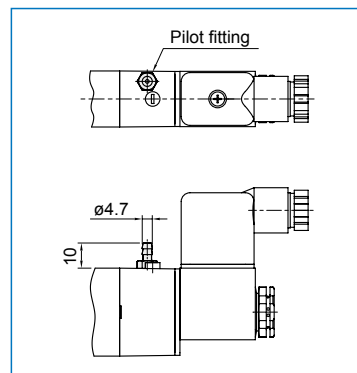

Flow features

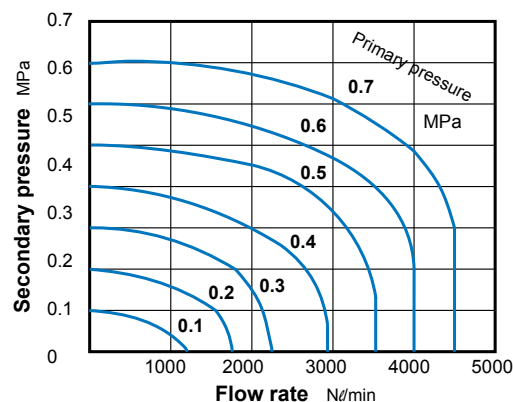

MVSC-460 Dimensions / Manifold

SOLENOID VALVE



MVSC-460-3E1-NC/NO

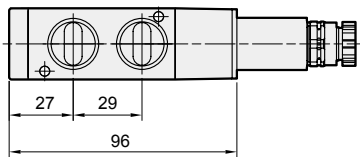
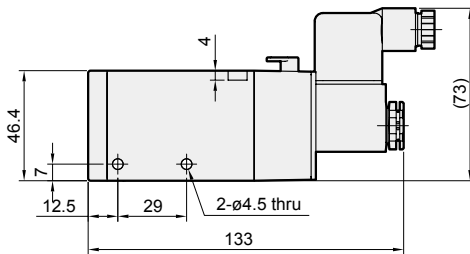
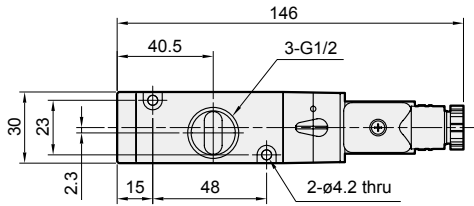
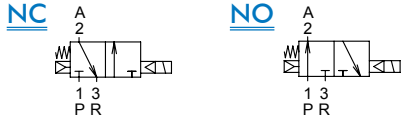

MVSC-460-3E2

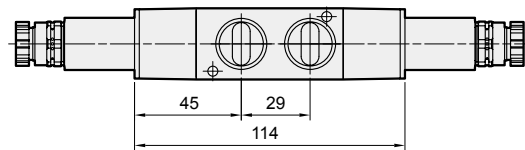
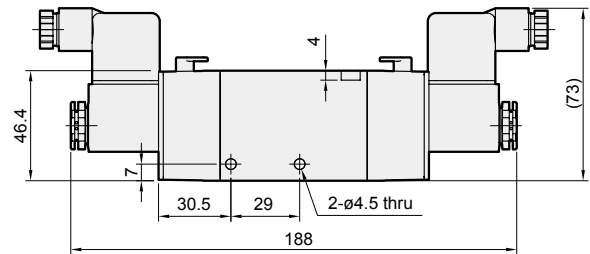
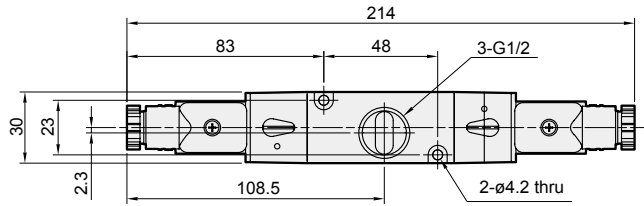
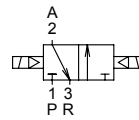

Manifold of solenoid valve

MVSC-460-3B*

3 port (for body ported type)

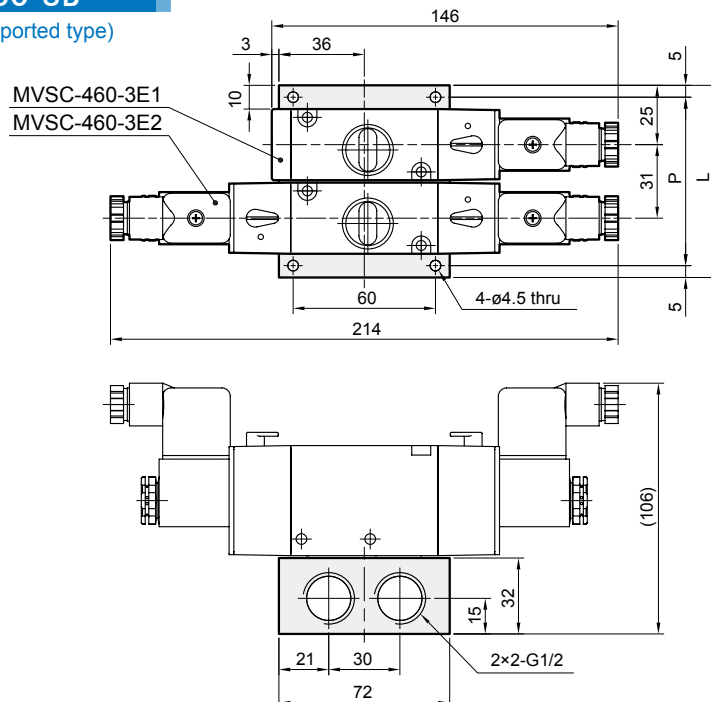

No. of stations	P	L
2	71	81
3	102	112
4	133	143
5	164	174
6	195	205
7	226	236
8	257	267
9	288	298
10	319	329

MVSC-460 Manifold

SOLENOID VALVE



MVSC-460-5B*

5 port (for body ported type)

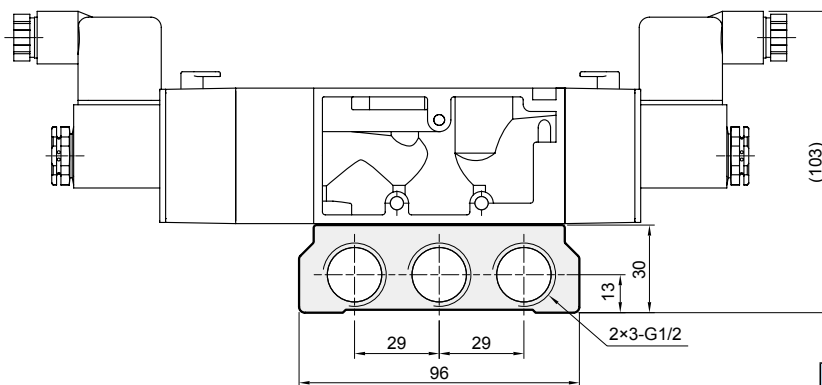
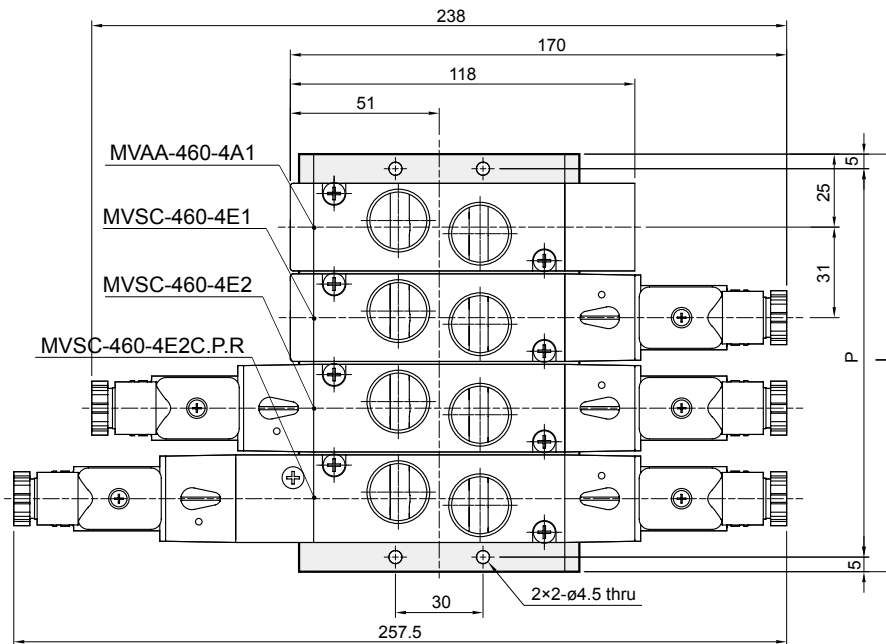

No. of stations	P	L
2	71	81
3	102	112
4	133	143
5	164	174
6	195	205
7	226	236
8	257	267
9	288	298
10	319	329