

PRODUCT DATASHEET

DL ALU DN 200 25 W 4000 K IP44/IP20 WT

DOWNLIGHT ALU | Downlight luminaires with aluminum housing



Areas of application

- Direct replacement for luminaires with compact fluorescent lamps
- General illumination
- Public areas
- Stairways
- Corridors
- Foyers
- Shops

Product benefits

- High luminous efficacy
- Energy savings up to 60 % (compared to luminaires that use CFL lamps)
- Very homogenous light
- Functional design
- Easy installation with fast connection
- External driver for extended flexibility (compatible with selected DALI drivers)
- 5 years guarantee

Product features

- Diameter of required ceiling cut-out: 150 mm or 200 mm (depending on version)
- Type of protection: IP44



TECHNICAL DATA

Electrical data

Nominal wattage	25.00 W
Nominal voltage	220...240 V
Mains frequency	50...60 Hz
Nominal current	110 mA
Inrush current	7 A
Max. no. of lum. on circuit break. C10 A	72
Power factor λ	> 0.90
Total harmonic distortion	< 20 %
Protection class	II
Operating mode	External LED driver
Max. number of luminaires per miniature circuit breaker C16	116
Max. number of luminaires per miniature circuit breaker B16	107

Photometrical data

Luminous flux	2370 lm
Luminous efficacy	95 lm/W
Color temperature	4000 K
Light color (designation)	Cool White
Color rendering index Ra	> 80
Standard deviation of color matching	≤ 6 sdc _m
Luminous intensity	-
Flickering metric (Pst LM)	-
Stroboscope effect metric (SVM)	-
Photobiological safety group acc. to EN62778	RG0
Photobiological safety group acc. to EN62471	RG0
Beam angle	100 °

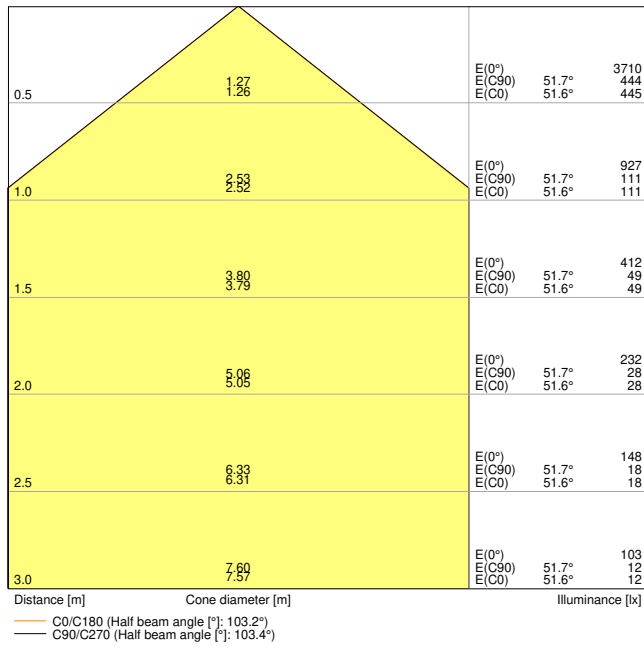

LDC typ cone

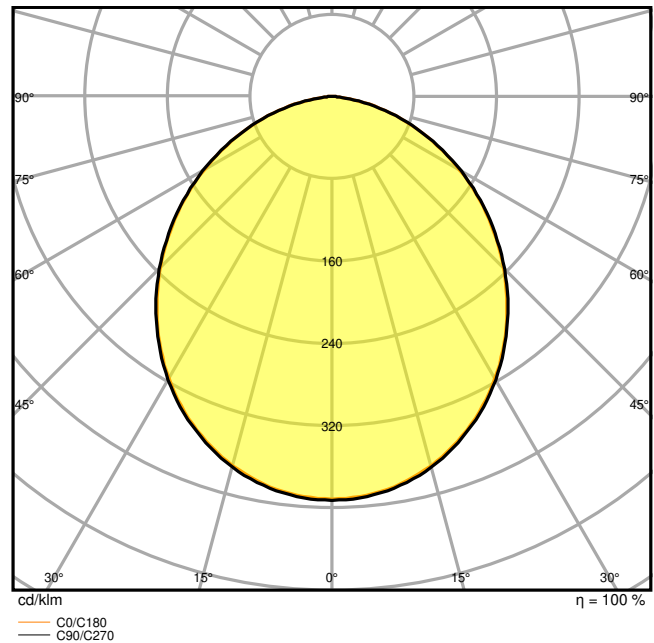

LDC typ polar

Dimensions & Weight

Diameter	215.00 mm
Height	61.00 mm
Product weight	600.00 g

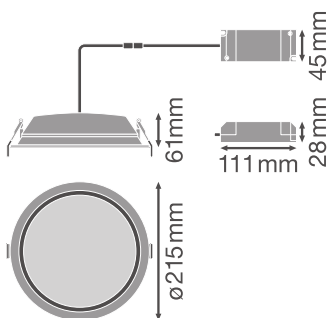

Materials & Colors

Product color	White
---------------	-------

Housing color	White
Body material	Aluminum
Cover material	Polymethylmethacrylate (PMMA)
Glow Wire Test according to IEC 60695-2-12	650 °C

Application & Mounting

Ambient temperature range	-20...+45 °C
Temperature range at storage	-20...+80 °C
Type of connection	Screw terminal, 2-Pole (L,N)
Type of protection	IP44/IP20
Protection class IK (shock resistance)	IK02
Dimmable	No
Mounting type	Recessed
Mounting location	Ceiling
Application environment	Indoor
Mounting diameter	200 mm
Mounting depth	120 mm
LED module replaceable	Not replaceable
With light source	Yes

Lifespan

Lifespan L70/B50 at 25 °C	50000 h ¹⁾
Lifespan L80/B10 at 25 °C	45000 h ¹⁾
Lifespan L90/B10 at 25 °C	30000 h
Number of switching cycles	100000

¹⁾ t[h]: L70 / B50 @ 25 °C (Ta), t[h]: L80 / B10 @ 25 °C (Ta), t[h]: L90 / B10 @ 25 °C (Ta)

Control gear

Output current	27...42 mA
ECG - Output ripple current	< 30 %
ECG - Length	111 mm
ECG - Width	45 mm
ECG - Height	28 mm

Certificates & Standards





Standards	CE / CB / ENEC / TÜV SÜD
Luminaire with limited surface temperature, "D sign"	No
Ball shot safe	No

Additional product data





Number of illuminants	Not relevant
-----------------------	--------------

DOWNLOAD DATA



Documents and certificates

	User instruction
	Addon Technical Information
	On-Pack-Info
	Declarations Of Conformity CE
	Declarations Of Conformity UKCA

Photometric and lighting design files

	IES file (IES)
	LDT file (Eulumdat)
	ULD file (DIALux)
	ROLF file (RELUX)
	UGR file (UGR table)
	LDC typ cone
	LDC typ polar

CAD/BIM files

	BIM_Revit_3D
	CAD_STEP_3D

Tender texts



Tender documents

LOGISTICAL DATA

Product code	Packaging unit (Pieces/Unit)	Dimensions (length x width x height)	Gross weight	Volume
4058075091511	Folding box 1	225 mm x 225 mm x 110 mm	775.00 g	5.57 dm ³
4058075091528	Shipping box 8	462 mm x 462 mm x 240 mm	7020.00 g	51.23 dm ³

The mentioned product code describes the smallest quantity unit which can be ordered. One shipping unit can contain one or more single products. When placing an order, for the quantity please enter single or multiples of a shipping unit.

ADDITIONAL CATALOG INFORMATION

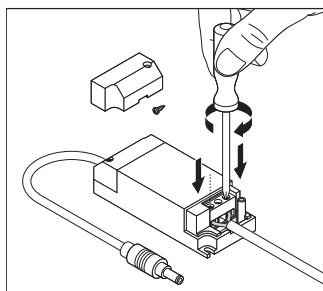

References / Links

– For Guarantee see www.ledvance.com/guarantee

DISCLAIMER

Subject to change without notice. Errors and omission excepted. Always make sure to use the most recent release.