







Sample image

Datasheet

Article number: 70018995
Designation: KG20A.T103/04.E
Description: Switch Global Disconnecter

IEC 60947-3 EN 60947-3, VDE 0660 Teil 107						
Rated insulation voltage Ui						
		Voltage (V) AC / DC				
		690 AC				
Rated uninterrupted current Iu/Ith						
Current (A)	Ambient temperature (°C)	Peak temperature (°C)		additional requirements		
25	50	55		Ambient temperature +50°C during 24 hours with peaks up to +55°C		
Rated operational current Ie						
Utilization category		Voltage (V)			Current (A)	
AC-32A		20 - 400			20	
Rated operational power						
Utilization category	Voltage (V)	No. of phases	No. of poles	Power (kW)		
AC-3	220 - 240	3	3	4		
AC-3	380 - 440	3	3	5,50		
AC-3	660 - 690	3	3	5,50		
AC-23A	220 - 240	3	3	5,50		
AC-23A	380 - 440	3	3	7,50		
AC-23A	660 - 690	3	3	7,50		
Max Fuse Rating IEC						
Fuse characteristic		No. of Fuses			Current (A)	
gG		1			35	
UL60947-4-1 , UL508						
Nominal Voltage						
		Voltage (V) AC / DC				
		600 AC				
Rated insulation voltage Ui						
		Voltage (V) AC / DC				
		600 AC				
Rated thermal current						
		Current (A)	Ambient temperature (°C)		Additional Text	
		25	0 - 40		-	
Horsepower rating						
Across-the-Line Motor Starting	Voltage (V)	No. of phases	No. of poles	Power (HP)	Ambient temperature [°C]	
DOL	110 - 120	1	2	1	40	
DOL	220 - 240	1	2	3	40	
DOL	277 - 277	1	2	3	40	
DOL	415 - 415	1	2	5	40	
DOL	440 - 480	1	2	5	40	
DOL	550 - 600	1	2	5	40	
DOL	110 - 120	3	3	2	40	
DOL	200 - 240	3	3	7,50	40	
DOL	415 - 415	3	3	10	40	
DOL	440 - 480	3	3	15	40	
DOL	550 - 600	3	3	20	40	
Pilot duty rating code						
Duty Code						
A600						
SCCR / Max. fuse rating						
Conditions of acceptability						
This device is suitable for use on circuits capable of delivering not more than 10kA rms symmetrical amperes, 600V ac max. when protected by Type RK1 fuses.						
Suitable for use on a circuit capable of delivering not more than 65000 rms symmetrical amperes at 600V max., when protected by 40A Class J fuses.						
Temp. rating of wire						
		Temperature rating (°C)	Current (A) Text			
		60 - 75	-- --			
General Use						
AC / DC	Voltage (V)	Current (A)	No. of phases	No. of poles	No. of contacts in series	
AC	277	25	1	1	1	
AC	600	25	1	2	1	

General Use						
AC / DC	Voltage (V)	Current (A)	No. of phases	No. of poles	No. of contacts in series	
AC	600	25	3	3	1	
General Information						
Text						
- The operating handle and position indicating means to be used with these manual motor controllers should be provided from the manufacturer, or the operating handle and position indicating means to be used should have been previously evaluated in combination with the manual motor controllers.						
- When intended for use as a motor disconnecter the device shall be provided with a method of being locked in the OFF-position.						
CSA						
Nominal Voltage						
Voltage (V) AC / DC						
600 AC						
Rated insulation voltage Ui						
Voltage (V) AC / DC						
600 AC						
Rated thermal current						
Current (A)						
25						
Ambient temperature (°C) Additional Text						
0 - 40 -						
Horsepower rating						
Across-the-Line Motor Starting	Voltage (V)	No. of phases	No. of poles	Power (HP)	Ambient temperature [°C]	
DOL	110 - 120	1	2	1	40	
DOL	220 - 240	1	2	3	40	
DOL	277 - 277	1	2	3	40	
DOL	415 - 415	1	2	5	40	
DOL	440 - 480	1	2	5	40	
DOL	550 - 600	1	2	5	40	
DOL	110 - 120	3	3	2	40	
DOL	220 - 240	3	3	7,50	40	
DOL	415 - 415	3	3	10	40	
DOL	440 - 480	3	3	15	40	
DOL	550 - 600	3	3	20	40	
Pilot duty rating code						
Duty Code						
A600						
Temp. rating of wire						
Temperature rating (°C)						
75						
Current (A) Text						
-- --						
General Use						
AC / DC	Voltage (V)	Current (A)	No. of phases	No. of poles	No. of contacts in series	
AC	277	25	1	1	1	
AC	600	25	1	2	1	
AC	600	25	3	3	1	
GENERAL TECHNICAL INFORMATION						
Tightening torque of screws						
tightening torque (Nm)						
1,25						
tightening torque (lb-in)						
11						
Stripping length						
Length (mm) -						
9 STRIPPINGLENGTH						
Size of conductor						
composition of conductor	Min. / Max. value	No. of conductor per terminal		Cross section (mm ²) or (AWG/kcmil)	Material of the wire	
flexible wire	Max.	1		AWG 10	Copper	
flexible wire	Max.	1		4mm ²	Copper	
Single-core or stranded wire	Max.	1		6mm ²	Copper	
Single-core or stranded wire	Max.	1		AWG 10	Copper	
flexible wire with sleeve	Max.	1		4mm ²	Copper	
Approbations						
Specification						Marking
EAC						
CE marking						
UK Directives						
CSA C.22.2 No.14						
GB/T14048.3						
Recommended screw driver						
Type of screw driver						
Cross Screwdriver						
Slot screwdriver according to DIN 5264						
Value						
PH2						
0,8x4						
General Information						
Text						
- EMC Note: This device is suitable for use in environment A and B.						

General Information

Text

- Do not lubricate or treat contacts.
- Switches may only be mounted, connected and set into operation by qualified persons according to the accepted rules of technology.
- Use copper wire only. Do not coat the wire end with tin.
- Terminals with factory fitted jumper links are tightened during production. Take care during installation to ensure factory fitted links are not lost by undoing both sides of linked terminals. After wiring, all terminal screws must be tightened to recommended torque specifications.

Waste Electrical & Electronic Equipment (WEEE)

Picture name

Description



Do not throw in the trash as care must be taken to ensure environmentally sound disposal and recycling. Please either use an environmentally friendly waste disposal company; return to the supplier for disposal, or return direct to the manufacturer, Kraus & Naimer. You can find local Kraus & Naimer offices at www.krausnaimer.com

Proposition 65

Picture name

Description



WARNING: This product can expose you to chemicals including nickel and lead, which is known to the State of California to cause cancer. For more information go to www.P65Warnings.ca.gov.

Classification Contact: Rigid contact bridge

Classification Contact Mat: Silver

Classification Terminal: Screw terminal

Mounting-E

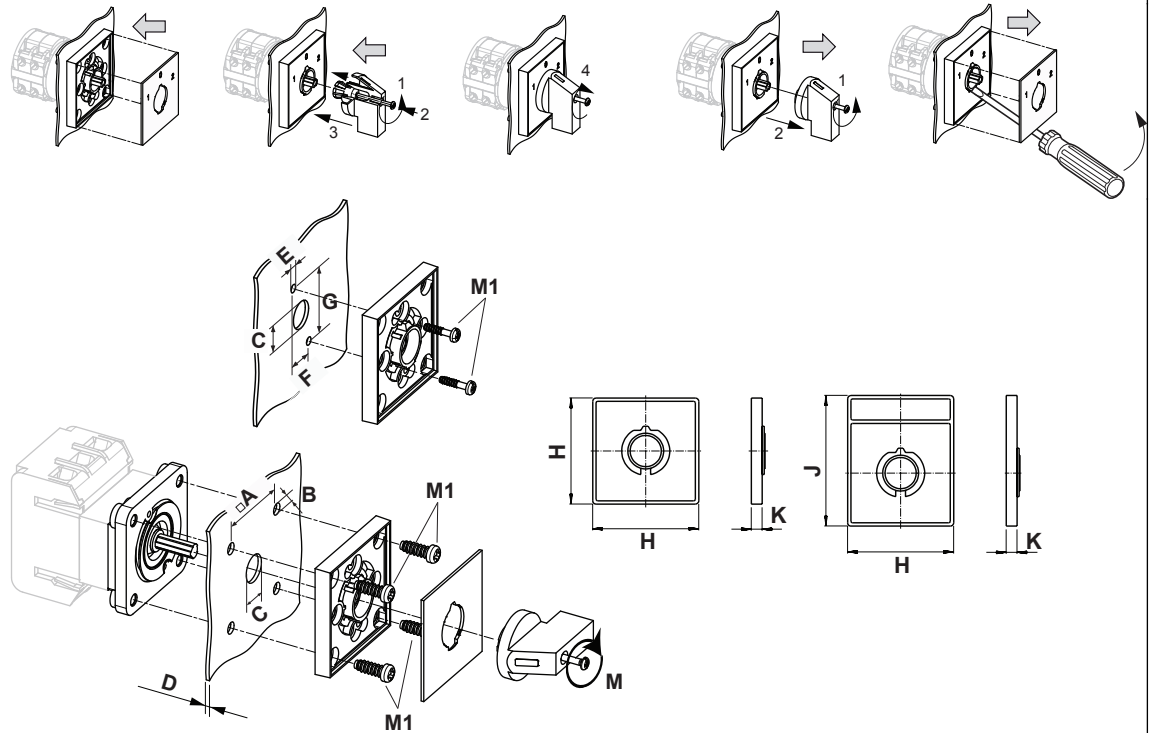

IP - Code front side		IP66, IP67
Stages		1,00 - 12,00
A	□	36,00 mm
B	∅	5,00 mm
C	∅	10,00 - 15,00 mm
D	H	<= 4,00 mm
E	∅	3,50 mm
F	H	12,20 mm
G	H	30,00 mm
H	H	48,00 mm
J	H	59,00 mm
K	H	6,30 mm
M	⌘	0,50 Nm
M1	⌘	0,90 Nm

Wiring diagram

KG20A.T303.E



Face plate

S0.F456/A10.E1LH

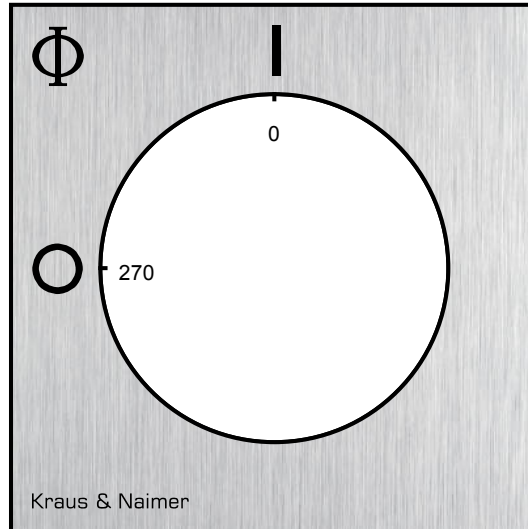

PADLOCK DEVICE

Designation: S0.V845/A11/A12

Face plate and handle unit: "A" face plate/alu, frame/black, handle/black, locking push rod/red

Locking position: "1" at 09:00/03:00 - knockouts every 45°

Angular displacement: "1" 1 x 90°

Type of mounting: "A" for type of mounting E

Type of mounting: "A" for type of mounting GK

Type of version: "1" for same switch size

Switch type: "2" for KA-, KG- and KH(R)-switches

