







Sample image

Datasheet

Article number: 70003124
Designation: CA10.A293.EF
Description: Switch

IEC 60947-3 EN 60947-3, VDE 0660 Teil 107						
Märkdriftspänning Ui						
Spänning (V) AC / DC						
690 AC / DC						
Rated impulse withstand voltage Uimp						
Voltage (kV)	Overvoltage category	Pollution degree	Supply system			Function
4 III		3	Valid for lines with grounded common neutral termination			Switch disconnecter
Märkdriftström vid konstant drift						
Ström (A)	Omgivningstemperatur (°C)	Temperatur topp (°C) ytterligare krav				
20	55	60 Omgivningstemperatur +55°C under 24 timmar med toppar upp till +60°C				
Märkdriftström Ie						
Urvals kriterie						Spänning (V)
AC-15						220 - 240
AC-15						380 - 440
						Ström (A)
						6
						4
Märkdrifteffekt						
Urvals kriterie	Spänning (V)	No. of phases	No. of poles	Effekt (kW)		
AC-3	220 - 240	3	3	3		
AC-3	380 - 440	3	3	5,50		
AC-3	660 - 690	3	3	5,50		
AC-3	220 - 240	1	2	2,20		
AC-3	380 - 440	1	2	3		
AC-23A	220 - 240	3	3	3,70		
AC-23A	380 - 440	3	3	7,50		
AC-23A	660 - 690	3	3	7,50		
AC-23A	220 - 240	1	2	2,50		
AC-23A	380 - 440	1	2	3,70		
Max försäkring, IEC						
Säkringskaraktäristik						Antal säkringar
gG						1
						Ström (A)
						25
UL60947-4-1 , UL508						
Nominal Voltage						
Spänning (V) AC / DC						
300 AC / DC						
Märkdriftspänning Ui						
Spänning (V) AC / DC						
300 AC						
Rated thermal current						
Ström (A)			Omgivningstemperatur (°C) Additional Text			
20			0 - 40 --			
Horsepower rating						
<i>Across-the-Line Motor Starting</i>						
	Spänning (V)	No. of phases	No. of poles	Power (HP)	Ambient temperature [°C]	
Reversing	110 - 120	1	2	0,17	40	
Reversing	220 - 240	1	2	0,50	40	
Reversing	277 - 277	1	2	0,60	40	
Reversing	110 - 120	3	3	0,50	40	
Reversing	220 - 240	3	3	1	40	
DOL	110 - 120	1	2	0,50	40	
DOL	220 - 240	1	2	1	40	
DOL	277 - 277	1	2	2	40	
DOL	110 - 120	3	3	1,50	40	
DOL	220 - 240	3	3	3	40	
Pilot duty rating code						
Duty Code						
A300						
SCCR / Max. fuse rating						
Conditions of acceptability						
These devices are suitable for use on circuits capable of delivering not more than 5000 rms symmetrical amperes, 600V ac max. when protected by Class RK1 fuses. Manual Motor Controllers when intended for use as a motor disconnecter are suitable for use on a circuit capable of delivering not more than 5000 rms symmetrical amperes, 600V ac max. when protected by 30A Class J time delay fuses.						
Temp. rating of wire						
Temperature rating (°C)			Ström (A) Text			
60 - 75			-- Use copper wire only			

Connecting instructions						
Markings						
När brytaren används som säkerhetsbrytare skall den vara utrustad med vred som är låsbart i läge "0".						
General Use						
AC / DC	Spänning (V)	Ström (A)	No. of phases	No. of poles	No. of contacts in series	
AC	300	20	1	2	1	
AC	300	20	3	3	1	
CSA						
Nominal Voltage						
				Spänning (V) AC / DC		
				300 AC		
Märkdriftspänning Ui						
				Spänning (V) AC / DC		
				300 AC		
Rated thermal current						
		Ström (A)	Omgivningstemperatur (°C)		Additional Text	
		20	0 - 40 -			
Horsepower rating						
<i>Across-the-Line Motor Starting</i>						
	Spänning (V)	No. of phases	No. of poles	Power (HP)	Ambient temperature [°C]	
DOL	110 - 120	1	2	0,50	40	
DOL	220 - 240	1	2	1	40	
DOL	277 - 277	1	2	2	40	
DOL	110 - 120	3	3	1,50	40	
DOL	220 - 240	3	3	3	40	
Pilot duty rating code						
Duty Code						
A300						
Temp. rating of wire						
			Temperature rating (°C)	Ström (A) Text		
			75	- only		
General Use						
AC / DC	Spänning (V)	Ström (A)	No. of phases	No. of poles	No. of contacts in series	
AC	300	20	1	1	1	
GENERAL TECHNICAL INFORMATION						
Tightening torque of screws						
				tightening torque (Nm)	tightening torque (lb-in)	
				0,60	5	
Stripping length						
				Length (mm) -		
				8 STRIPPINGLENGTH		
Size of conductor						
composition of conductor	Min. / Max. value	No. of conductor per terminal		Cross section (mm ²) or (AWG/kcmil)	Material of the wire	
solid wire	Min.	1		0,5mm ²	Copper	
solid wire	Min.	2		0,5mm ²	Copper	
flexible wire	Min.	1		0,75mm ²	Copper	
flexible wire	Min.	2		0,75mm ²	Copper	
flexible wire	Max.	2		2,5mm ²	Copper	
flexible wire	Max.	2		AWG 14	Copper	
Single-core or stranded wire	Max.	2		AWG 12	Copper	
Single-core or stranded wire	Max.	2		2,5mm ²	Copper	
flexible wire with ferrule according to DIN 46228	Min.	1		0,5mm ²	Copper	
flexible wire with ferrule according to DIN 46228	Max.	2		2,5mm ²	Copper	
flexible wire with ferrule according to DIN 46228	Min.	2		0,5mm ²	Copper	
Approbations						
Specification						Marking
EAC						
CE marking						
UK Directives						
CSA C.22.2 No.14						
GB/T14048.3						
Rekomenderad skruvmejsel						
Typ av skruvmejsel				Value		
Stjärnskruvmejsel				PH1		
Slot screwdriver according to DIN 5264				0,8x4		
General Information						
Text						
- Smörjning och behandling av kontakterna är förbjuden.						
- Inkoppling och service av strömställaren får endast utföras av behörig personal. Strömställaren är underhållsfri.						

General Information

Text

- Använd endast kopparkabel. Kabeln får inte förtennas.
- Alla anslutningsskruvar måste dras med rekommenderat moment, även de som inte används då det kan finnas interna överkopplingar.
- Vid installation av strömställaren skall kontrolleras att kryp- och luftavstånd motsvarar gällande föreskrifter.

Waste Electrical & Electronic Equipment (WEEE)

Picture name

Description



Do not throw in the trash as care must be taken to ensure environmentally sound disposal and recycling. Please either use an environmentally friendly waste disposal company; return to the supplier for disposal; or return direct to the manufacturer, Kraus & Naimer. You can find local Kraus & Naimer offices at www.krausnaimer.com

Proposition 65

Picture name

Description



WARNING: This product can expose you to chemicals including nickel and lead, which is known to the State of California to cause cancer. For more information go to www.P65Warnings.ca.gov.

Classification Contact: Rigid contact bridge

Classification Contact Mat: Silver

Classification Terminal: Screw terminal

Mounting-EF

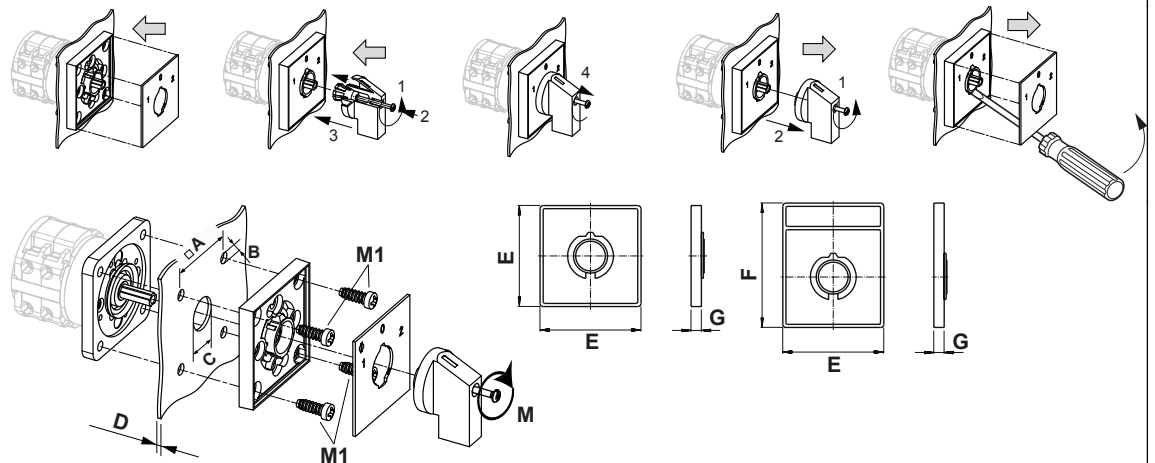

Skyddsklass frontpanel, IP		IP66, IP67, IP69k
Stages		1,00 - 12,00
A	□	36,00 mm
B	∅	5,00 mm
C	∅	15,00 - 19,00 mm
D	H	<= 4,00 mm
E	H	48,00 mm
F	H	59,00 mm
G	H	6,70 mm
M	⌀	0,50 Nm
M1	⌀	0,90 Nm

Wiring diagram

CA10.A293.EF

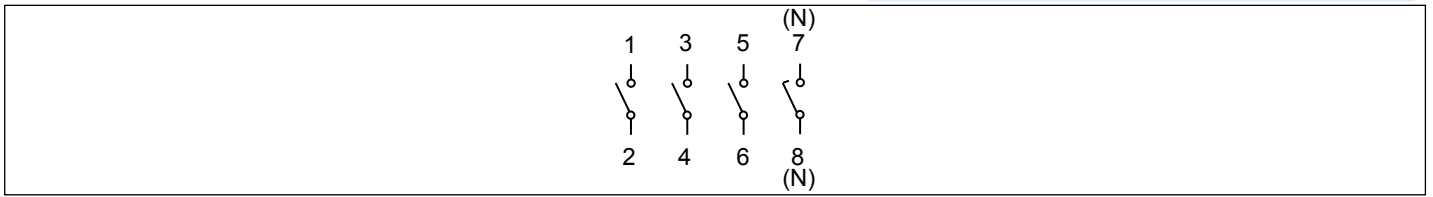

Switch program

CA10.A293.EF

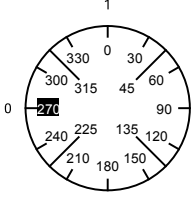
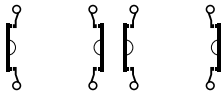
 Kraus & Naimer		CA10	A293	Page 1 of 1											
Face Plate															
		1	3	5	7	9	11	13	15	17	19	21	23		
															
Switching Angle <input type="text" value="90"/> Total switching Angle <input type="text" value="90"/>		2	4	6	8	10	12	14	16	18	20	22	24		
0	270														
	285														
	300														
	315														
	330														
	345														
1	0														
	15														
	30														
	45														
	60														
	75														
	90														
	105														
	120														
	135														
	150														
	165														
	180														
	195														
	210														
	225														
	240														
	255														
Version: 87															

Face plate

S0.F056/A1B.PEL

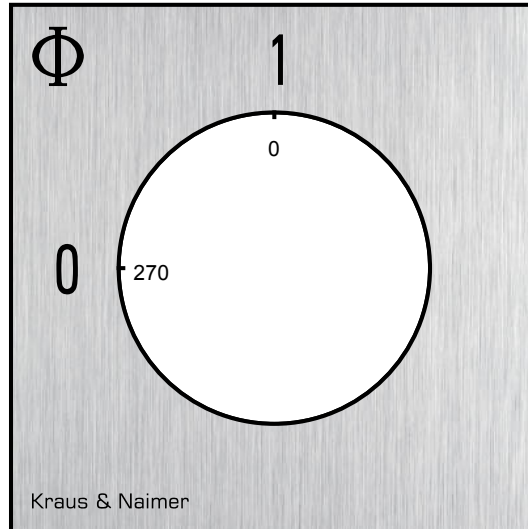

HANDLES

Designation: S0C.G251
Handle colour: "1" black

