







Sample image

## Datasheet

**Article number:** 70003066  
**Designation:** CA10.A291.EF  
**Description:** Switch

IEC 60947-3 EN 60947-3, VDE 0660 Teil 107						
<b>Rated insulation voltage Ui</b>						
			Voltage (V) AC / DC			
			690 AC / DC			
<b>Rated impulse withstand voltage Uimp</b>						
Voltage (kV)	Overvoltage category	Pollution degree	Supply system			Function
4 III		3	Valid for lines with grounded common neutral termination			Switch disconnecter
<b>Rated uninterrupted current Iu/Ith</b>						
Current (A)	Ambient temperature (°C)	Peak temperature (°C) additional requirements				
20	55	60 Ambient temperature +55°C during 24 hours with peaks up to +60°C				
<b>Rated operational current Ie</b>						
Utilization category			Voltage (V)		Current (A)	
AC-15			220 - 240		6	
AC-15			380 - 440		4	
<b>Rated operational power</b>						
Utilization category	Voltage (V)	No. of phases	No. of poles	Power (kW)		
AC-3	220 - 240	3	3	3		
AC-3	380 - 440	3	3	5,50		
AC-3	660 - 690	3	3	5,50		
AC-3	220 - 240	1	2	2,20		
AC-3	380 - 440	1	2	3		
AC-23A	220 - 240	3	3	3,70		
AC-23A	380 - 440	3	3	7,50		
AC-23A	660 - 690	3	3	7,50		
AC-23A	220 - 240	1	2	2,50		
AC-23A	380 - 440	1	2	3,70		
<b>Max Fuse Rating IEC</b>						
Fuse characteristic			No. of Fuses		Current (A)	
gG			1		25	
<b>UL60947-4-1 , UL508</b>						
<b>Nominal Voltage</b>						
			Voltage (V) AC / DC			
			300 AC / DC			
<b>Rated insulation voltage Ui</b>						
			Voltage (V) AC / DC			
			300 AC			
<b>Rated thermal current</b>						
		Current (A)	Ambient temperature (°C)		Additional Text	
		20	0 - 40		-	
<b>Horsepower rating</b>						
Across-the-Line Motor Starting		Voltage (V)	No. of phases	No. of poles	Power (HP)	Ambient temperature [°C]
Reversing		110 - 120	1	2	0,17	40
Reversing		220 - 240	1	2	0,50	40
Reversing		277 - 277	1	2	0,60	40
Reversing		110 - 120	3	3	0,50	40
Reversing		220 - 240	3	3	1	40
DOL		110 - 120	1	2	0,50	40
DOL		220 - 240	1	2	1	40
DOL		277 - 277	1	2	2	40
DOL		110 - 120	3	3	1,50	40
DOL		220 - 240	3	3	3	40
<b>Pilot duty rating code</b>						
Duty Code						
A300						
<b>SCCR / Max. fuse rating</b>						
Conditions of acceptability						
These devices are suitable for use on circuits capable of delivering not more than 5000 rms symmetrical amperes, 600V ac max. when protected by Class RK1 fuses. Manual Motor Controllers when intended for use as a motor disconnecter are suitable for use on a circuit capable of delivering not more than 5000 rms symmetrical amperes, 600V ac max. when protected by 30A Class J time delay fuses.						
<b>Temp. rating of wire</b>						
		Temperature rating (°C)	Current (A)		Text	
		60 - 75			- Use copper wire only	

Connecting instructions						
<b>Markings</b>						
When intended for use as a motor disconnecter the device shall be provided with a method of being locked in the OFF-position.						
<b>General Use</b>						
AC / DC	Voltage (V)	Current (A)	No. of phases	No. of poles	No. of contacts in series	
AC	300	20	1	2	1	
AC	300	20	3	3	1	
<b>CSA</b>						
<b>Nominal Voltage</b>						
				Voltage (V)	AC / DC	
				300 AC		
<b>Rated insulation voltage Ui</b>						
				Voltage (V)	AC / DC	
				300 AC		
<b>Rated thermal current</b>						
		Current (A)	Ambient temperature (°C)		Additional Text	
		20	0 - 40		-	
<b>Horsepower rating</b>						
<i>Across-the-Line Motor Starting</i>						
	Voltage (V)	No. of phases	No. of poles	Power (HP)	Ambient temperature [°C]	
DOL	110 - 120	1	2	0,50	40	
DOL	220 - 240	1	2	1	40	
DOL	277 - 277	1	2	2	40	
DOL	110 - 120	3	3	1,50	40	
DOL	220 - 240	3	3	3	40	
<b>Pilot duty rating code</b>						
<i>Duty Code</i>						
A300						
<b>Temp. rating of wire</b>						
		Temperature rating (°C)	Current (A)		Text	
		75			- only	
<b>General Use</b>						
AC / DC	Voltage (V)	Current (A)	No. of phases	No. of poles	No. of contacts in series	
AC	300	20	1	1	1	
<b>GENERAL TECHNICAL INFORMATION</b>						
<b>Tightening torque of screws</b>						
				tightening torque (Nm)	tightening torque (lb-in)	
				0,60	5	
<b>Stripping length</b>						
				Length (mm)	-	
				8 STRIPPINGLENGTH		
<b>Size of conductor</b>						
<i>composition of conductor</i>	<i>Min. / Max. value</i>		<i>No. of conductor per terminal</i>	<i>Cross section (mm<sup>2</sup>) or (AWG/kcmil)</i>		<i>Material of the wire</i>
solid wire	Min.		1	0.5mm <sup>2</sup>		Copper
solid wire	Min.		2	0.5mm <sup>2</sup>		Copper
flexible wire	Min.		1	0.75mm <sup>2</sup>		Copper
flexible wire	Min.		2	0.75mm <sup>2</sup>		Copper
flexible wire	Max.		2	2.5mm <sup>2</sup>		Copper
flexible wire	Max.		2	AWG 14		Copper
Single-core or stranded wire	Max.		2	AWG 12		Copper
Single-core or stranded wire	Max.		2	2.5mm <sup>2</sup>		Copper
flexible wire with ferrule according to DIN 46228	Min.		1	0.5mm <sup>2</sup>		Copper
flexible wire with ferrule according to DIN 46228	Max.		2	2.5mm <sup>2</sup>		Copper
flexible wire with ferrule according to DIN 46228	Min.		2	0.5mm <sup>2</sup>		Copper
<b>Approbations</b>						
<i>Specification</i>						<i>Marking</i>
EAC						
CE marking						
UK Directives						
CSA C.22.2 No.14						
GB/T14048.3						 GB/T14048.3
<b>Recommended screw driver</b>						
<i>Type of screw driver</i>				<i>Value</i>		
Cross Screwdriver				PH1		
Slot screwdriver according to DIN 5264				0,8x4		
<b>General Information</b>						
<i>Text</i>						
- Do not lubricate or treat contacts.						
- Switches may only be mounted, connected and set into operation by qualified persons according to the accepted rules of technology.						

### General Information

#### Text

- Use copper wire only. Do not coat the wire end with tin.
- Terminals with factory fitted jumper links are tightened during production. Take care during installation to ensure factory fitted links are not lost by undoing both sides of linked terminals. After wiring, all terminal screws must be tightened to recommended torque specifications.
- After installation of the switches the spacings between the terminals must be sufficient to fulfill the requirement of the applicable standards.

### Waste Electrical & Electronic Equipment (WEEE)

#### Picture name Description

 Do not throw in the trash as care must be taken to ensure environmentally sound disposal and recycling. Please either use an environmentally friendly waste disposal company; return to the supplier for disposal; or return direct to the manufacturer, Kraus & Naimer. You can find local Kraus & Naimer offices at [www.krausnaimer.com](http://www.krausnaimer.com)

### Proposition 65

#### Picture name Description

 **WARNING:** This product can expose you to chemicals including nickel and lead, which is known to the State of California to cause cancer. For more information go to [www.P65Warnings.ca.gov](http://www.P65Warnings.ca.gov).

Classification Contact: Rigid contact bridge

Classification Contact Mat: Silver

Classification Terminal: Screw terminal

### Mounting-EF

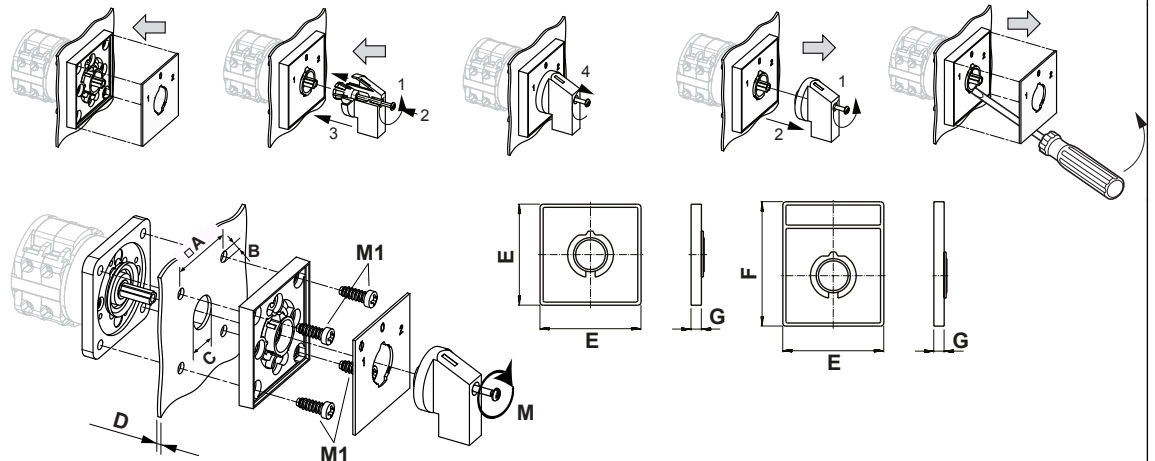

IP - Code front side		IP66, IP67, IP69k
Stages		1,00 - 12,00
A	□	36,00 mm
B	∅	5,00 mm
C	∅	15,00 - 19,00 mm
D	H	<= 4,00 mm
E	H	48,00 mm
F	H	59,00 mm
G	H	6,70 mm
M	$\vec{m}$	0,50 Nm
M1	$\vec{m}$	0,90 Nm

## Wiring diagram

CA10.A291.EF

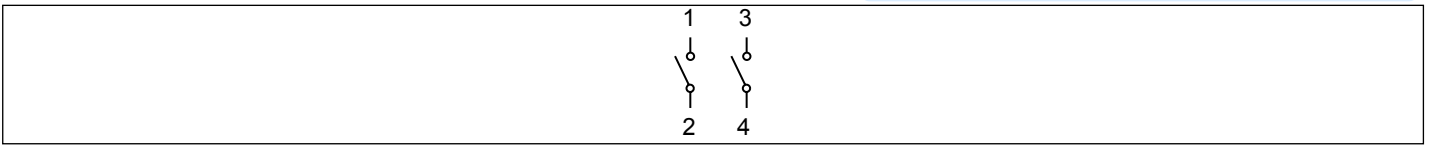

**Switch program**

CA10.A291.EF

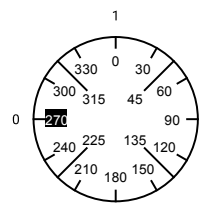
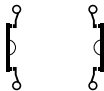
 Kraus & Naimer		<b>CA10</b>	<b>A291</b>	<b>Page 1 of 1</b>											
<b>Face Plate</b>															
		1	3	5	7	9	11	13	15	17	19	21	23		
															
Switching Angle <input type="text" value="90"/> Total switching Angle <input type="text" value="90"/>		2	4	6	8	10	12	14	16	18	20	22	24		
0	270														
	285														
	300														
	315														
	330														
	345														
1	0														
	15														
	30														
	45														
	60														
	75														
	90														
	105														
	120														
	135														
	150														
	165														
	180														
	195														
	210														
	225														
	240														
	255														

Version: 96

**Face plate**

S0.F056/A1B.PEL

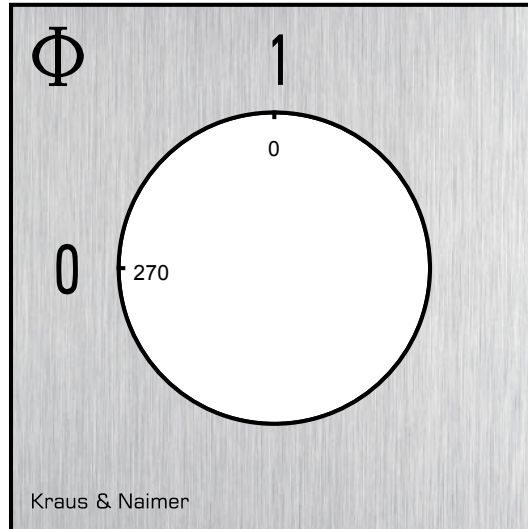

## HANDLES

**Designation:** S0C.G251  
**Handle colour:** "1" black

