



Sample image





## Datasheet

**Article number:** 70024128

**Designation:** KG20.T104/33.KL51V

**Description:** Switch Global Disconnecter

|  |                          |                         |                          |                  |  |                           |
|--|--------------------------|-------------------------|--------------------------|------------------|--|---------------------------|
| <b>IEC 60947-3 EN 60947-3, VDE 0660 Teil 107</b>   |                          |                         |                          |                  |  |                           |
| <b>Rated insulation voltage Ui</b>   |                          |                         |                          |                  |  |                           |
|  |                          |                         | Voltage (V) AC / DC      |                  |  |                           |
|  |                          |                         | 690 AC                   |                  |  |                           |
| <b>Rated uninterrupted current Iu/Ith</b>  |                          |                         |                          |                  |  |                           |
| Current (A)  | Ambient temperature (°C) |                         | Peak temperature (°C)    |                  | additional requirements  |                           |
| 25   | 50                       |                         | 55                       |                  | Ambient temperature +50°C during 24 hours with peaks up to +55°C |                           |
| <b>Rated operational current Ie</b>  |                          |                         |                          |                  |  |                           |
| Utilization category   |                          |                         | Voltage (V)              |                  | Current (A)  |                           |
| AC-32A   |                          |                         | 20 - 400                 |                  | 20   |                           |
| <b>Rated operational power</b>   |                          |                         |                          |                  |  |                           |
| Utilization category   | Voltage (V)              |                         | No. of phases            |                  | No. of poles   |                           |
| AC-3   | 220 - 240                |                         | 3                        |                  | 3  |                           |
| AC-3   | 380 - 440                |                         | 3                        |                  | 3  |                           |
| AC-3   | 660 - 690                |                         | 3                        |                  | 3  |                           |
| AC-23A   | 220 - 240                |                         | 3                        |                  | 3  |                           |
| AC-23A   | 380 - 440                |                         | 3                        |                  | 3  |                           |
| AC-23A   | 660 - 690                |                         | 3                        |                  | 3  |                           |
| <b>Max Fuse Rating IEC</b>   |                          |                         |                          |                  |  |                           |
| Fuse characteristic  |                          |                         | No. of Fuses             |                  | Current (A)  |                           |
| gG   |                          |                         | 1                        |                  | 35   |                           |
| <b>UL60947-4-1 , UL508</b>   |                          |                         |                          |                  |  |                           |
| <b>Nominal Voltage</b>   |                          |                         |                          |                  |  |                           |
|  |                          |                         | Voltage (V) AC / DC      |                  |  |                           |
|  |                          |                         | 600 AC                   |                  |  |                           |
| <b>Rated insulation voltage Ui</b>   |                          |                         |                          |                  |  |                           |
|  |                          |                         | Voltage (V) AC / DC      |                  |  |                           |
|  |                          |                         | 600 AC                   |                  |  |                           |
| <b>Rated thermal current</b>   |                          |                         |                          |                  |  |                           |
|  |                          | Current (A)             | Ambient temperature (°C) |                  | Additional Text  |                           |
|  |                          | 25                      | 0 - 40                   |                  | -  |                           |
| <b>Horsepower rating</b>   |                          |                         |                          |                  |  |                           |
| Across-the-Line Motor Starting   | Voltage (V)              |                         | No. of phases            |                  | No. of poles   |                           |
| DOL  | 110 - 120                |                         | 1                        |                  | 2  |                           |
| DOL  | 220 - 240                |                         | 1                        |                  | 2  |                           |
| DOL  | 277 - 277                |                         | 1                        |                  | 2  |                           |
| DOL  | 415 - 415                |                         | 1                        |                  | 2  |                           |
| DOL  | 440 - 480                |                         | 1                        |                  | 2  |                           |
| DOL  | 550 - 600                |                         | 1                        |                  | 2  |                           |
| DOL  | 110 - 120                |                         | 3                        |                  | 3  |                           |
| DOL  | 200 - 240                |                         | 3                        |                  | 3  |                           |
| DOL  | 415 - 415                |                         | 3                        |                  | 3  |                           |
| DOL  | 440 - 480                |                         | 3                        |                  | 3  |                           |
| DOL  | 550 - 600                |                         | 3                        |                  | 3  |                           |
| <b>Pilot duty rating code</b>  |                          |                         |                          |                  |  |                           |
| Duty Code  |                          |                         |                          |                  |  |                           |
| A600   |                          |                         |                          |                  |  |                           |
| <b>SCCR / Max. fuse rating</b>   |                          |                         |                          |                  |  |                           |
| Conditions of acceptability  |                          |                         |                          |                  |  |                           |
| This device is suitable for use on circuits capable of delivering not more than 10kA rms symmetrical amperes, 600V ac max. when protected by Type RK1 fuses. |                          |                         |                          |                  |  |                           |
| Suitable for use on a circuit capable of delivering not more than 65000 rms symmetrical amperes at 600V max., when protected by 40A Class J fuses.           |                          |                         |                          |                  |  |                           |
| <b>Temp. rating of wire</b>  |                          |                         |                          |                  |  |                           |
|  |                          | Temperature rating (°C) |                          | Current (A) Text |  |                           |
|  |                          | 60 - 75                 |                          | -- --            |  |                           |
| <b>General Use</b>   |                          |                         |                          |                  |  |                           |
| AC / DC  | Voltage (V)              | Current (A)             | No. of phases            | No. of poles     |  | No. of contacts in series |
| AC   | 277                      | 25                      | 1                        | 1                |  | 1                         |
| AC   | 600                      | 25                      | 1                        | 2                |  | 1                         |

| General Use  |                   |                               |                  |   |                           |   |
|--|-------------------|-------------------------------|------------------|---|---------------------------|---|
| AC / DC  | Voltage (V)       | Current (A)                   | No. of phases    | No. of poles                                    | No. of contacts in series |   |
| AC   | 600               | 25                            | 3                | 3   | 1                         |   |
| General Information  |                   |                               |                  |   |                           |   |
| Text   |                   |                               |                  |   |                           |   |
| - The operating handle and position indicating means to be used with these manual motor controllers should be provided from the manufacturer, or the operating handle and position indicating means to be used should have been previously evaluated in combination with the manual motor controllers. |                   |                               |                  |   |                           |   |
| - When intended for use as a motor disconnecter the device shall be provided with a method of being locked in the OFF-position.  |                   |                               |                  |   |                           |   |
| CSA  |                   |                               |                  |   |                           |   |
| Nominal Voltage  |                   |                               |                  |   |                           |   |
| Voltage (V) AC / DC<br>600 AC  |                   |                               |                  |   |                           |   |
| Rated insulation voltage Ui  |                   |                               |                  |   |                           |   |
| Voltage (V) AC / DC<br>600 AC  |                   |                               |                  |   |                           |   |
| Rated thermal current  |                   |                               |                  |   |                           |   |
| Current (A)  |                   | Ambient temperature (°C)      |                  | Additional Text                                 |                           |   |
| 25   |                   | 0 - 40                        |                  | -   |                           |   |
| Horsepower rating  |                   |                               |                  |   |                           |   |
| Across-the-Line Motor Starting   | Voltage (V)       | No. of phases                 | No. of poles     | Power (HP)                                      | Ambient temperature [°C]  |   |
| DOL  | 110 - 120         | 1                             | 2                | 1   | 40                        |   |
| DOL  | 220 - 240         | 1                             | 2                | 3   | 40                        |   |
| DOL  | 277 - 277         | 1                             | 2                | 3   | 40                        |   |
| DOL  | 415 - 415         | 1                             | 2                | 5   | 40                        |   |
| DOL  | 440 - 480         | 1                             | 2                | 5   | 40                        |   |
| DOL  | 550 - 600         | 1                             | 2                | 5   | 40                        |   |
| DOL  | 110 - 120         | 3                             | 3                | 2   | 40                        |   |
| DOL  | 220 - 240         | 3                             | 3                | 7,50  | 40                        |   |
| DOL  | 415 - 415         | 3                             | 3                | 10  | 40                        |   |
| DOL  | 440 - 480         | 3                             | 3                | 15  | 40                        |   |
| DOL  | 550 - 600         | 3                             | 3                | 20  | 40                        |   |
| Pilot duty rating code   |                   |                               |                  |   |                           |   |
| Duty Code<br>A600  |                   |                               |                  |   |                           |   |
| Temp. rating of wire   |                   |                               |                  |   |                           |   |
| Temperature rating (°C)  |                   |                               | Current (A) Text |   |                           |   |
| 75   |                   |                               | -- --            |   |                           |   |
| General Use  |                   |                               |                  |   |                           |   |
| AC / DC  | Voltage (V)       | Current (A)                   | No. of phases    | No. of poles                                    | No. of contacts in series |   |
| AC   | 277               | 25                            | 1                | 1   | 1                         |   |
| AC   | 600               | 25                            | 1                | 2   | 1                         |   |
| AC   | 600               | 25                            | 3                | 3   | 1                         |   |
| GENERAL TECHNICAL INFORMATION  |                   |                               |                  |   |                           |   |
| Tightening torque of screws  |                   |                               |                  |   |                           |   |
| tightening torque (Nm)   |                   |                               |                  | tightening torque (lb-in)                       |                           |   |
| 1,25   |                   |                               |                  | 11  |                           |   |
| Stripping length   |                   |                               |                  |   |                           |   |
| Length (mm) -<br>9 STRIPPINGLENGTH   |                   |                               |                  |   |                           |   |
| Size of conductor  |                   |                               |                  |   |                           |   |
| composition of conductor   | Min. / Max. value | No. of conductor per terminal |                  | Cross section (mm <sup>2</sup> ) or (AWG/kcmil) | Material of the wire      |   |
| solid wire   | Min.              | 1                             |                  | 0.75mm <sup>2</sup>                             | Copper                    |   |
| solid wire   | Min.              | 2                             |                  | 0.5mm <sup>2</sup>                              | Copper                    |   |
| flexible wire  | Min.              | 2                             |                  | 0.75mm <sup>2</sup>                             | Copper                    |   |
| flexible wire  | Max.              | 1                             |                  | AWG 10  | Copper                    |   |
| flexible wire  | Max.              | 1                             |                  | 4mm <sup>2</sup>                                | Copper                    |   |
| flexible wire  | Min.              | 1                             |                  | 1.5mm <sup>2</sup>                              | Copper                    |   |
| Single-core or stranded wire   | Max.              | 1                             |                  | 6mm <sup>2</sup>                                | Copper                    |   |
| Single-core or stranded wire   | Max.              | 1                             |                  | AWG 10  | Copper                    |   |
| flexible wire with sleeve  | Max.              | 1                             |                  | 4mm <sup>2</sup>                                | Copper                    |   |
| flexible wire with ferrule according to DIN 46228  | Min.              | 1                             |                  | 0.75mm <sup>2</sup>                             | Copper                    |   |
| flexible wire with ferrule according to DIN 46228  | Min.              | 2                             |                  | 0.5mm <sup>2</sup>                              | Copper                    |   |
| Approbations   |                   |                               |                  |   |                           |   |
| Specification  |                   |                               |                  |   |                           | Marking   |
| EAC  |                   |                               |                  |   |                           |  |
| CE marking   |                   |                               |                  |   |                           |  |
| UK Directives  |                   |                               |                  |   |                           |  |
| CSA C.22.2 No.14   |                   |                               |                  |   |                           |  |
| GB/T14048.3  |                   |                               |                  |   |                           |  |

| Recommended screw driver               |       |
|--|-------|
| Type of screw driver                   | Value |
| Cross Screwdriver                      | PH2   |
| Slot screwdriver according to DIN 5264 | 0,8x4 |

| General Information  |  |
|--|--|
| Text   |  |
| <ul style="list-style-type: none"> <li>- EMC Note: This device is suitable for use in environment A and B.</li> <li>- Do not lubricate or treat contacts.</li> <li>- Switches may only be mounted, connected and set into operation by qualified persons according to the accepted rules of technology.</li> <li>- Use copper wire only. Do not coat the wire end with tin.</li> <li>- Terminals with factory fitted jumper links are tightened during production. Take care during installation to ensure factory fitted links are not lost by undoing both sides of linked terminals. After wiring, all terminal screws must be tightened to recommended torque specifications.</li> </ul> |  |

| Waste Electrical & Electronic Equipment (WEEE)                                   |  |
|--|--|
| Picture name   | Description  |
|  | Do not throw in the trash as care must be taken to ensure environmentally sound disposal and recycling. Please either use an environmentally friendly waste disposal company; return to the supplier for disposal; or return direct to the manufacturer, Kraus & Naimer. You can find local Kraus & Naimer offices at <a href="http://www.krausnaimer.com">www.krausnaimer.com</a> |

| Proposition 65   |   |
|--|---|
| Picture name   | Description   |
|  | WARNING: This product can expose you to chemicals including nickel and lead, which is known to the State of California to cause cancer. For more information go to <a href="http://www.P65Warnings.ca.gov">www.P65Warnings.ca.gov</a> . |

|  |
|--|
| Classification Contact: Rigid contact bridge |
| Classification Contact Mat: Silver           |
| Classification Terminal: Screw terminal      |

## Mounting-KL51V

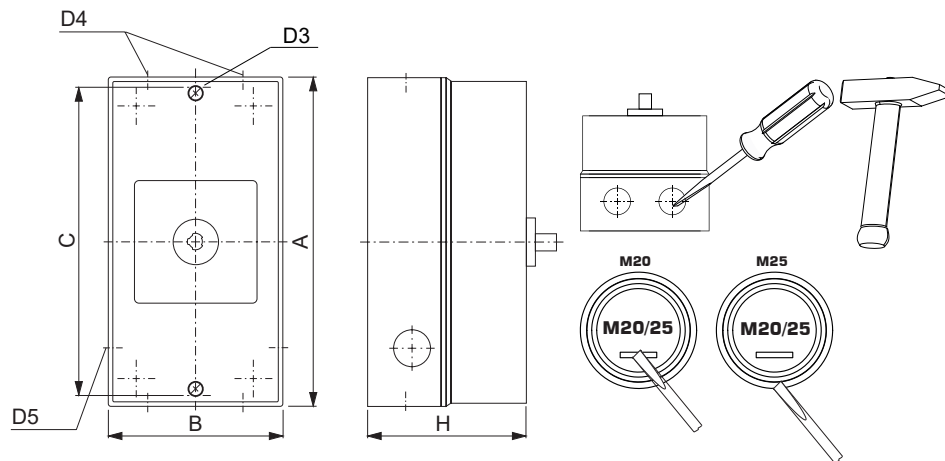

|                      |                   |
|----------------------|-------------------|
| IP - Code front side | IP66, IP67, IP69k |
| Stages               | 1,00 - 5,00       |
| A                    | H 160,00 mm       |
| B                    | H 85,00 mm        |
| C                    | H 150,00 mm       |
| D3                   | Ø 4,20 mm         |
| D4                   | Ø 4,00 x M20/M25  |
| D5                   | Ø 2,00 x M20      |
| H                    | H 82,00 mm        |





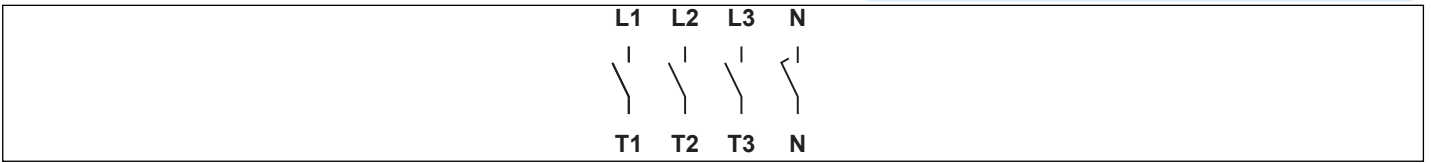

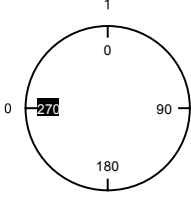

## Wiring diagram

KG20.T304.KL51V



**Switch program**  
KG20.T304.KL51V

 Kraus & Naimer

|  |            |  |  |  |  |   |           |   |           |                    |  |  |  |
|--|------------|--|--|--|--|---|-----------|---|-----------|--------------------|--|--|--|
|  |            | <b>KG20</b>  |  |  |  | <b>T304</b>   |           |   |           | <b>Page 1 of 1</b> |  |  |  |
| <b>Face Plate</b>  |            |  |  |  |  |   |           |   |           |                    |  |  |  |
|                         |            | <b>L1</b>  | <b>L2</b>  | <b>L3</b>  | <b>N</b>   |   |           |   |           |                    |  |  |  |
|  |            | 1  | 3  | 5  | 7  | 9   | 11        | 13  | 15        |                    |  |  |  |
|  |            |   |  |   |  |  |           |  |           |                    |  |  |  |
| Switching Angle <input type="text" value="90"/><br>Total switching Angle <input type="text" value="90"/> |            | <b>2</b>   | <b>4</b>   | <b>6</b>   | <b>8</b>   | <b>10</b>   | <b>12</b> | <b>14</b>   | <b>16</b> |                    |  |  |  |
|  |            | <b>T1</b>  | <b>T2</b>  | <b>T3</b>  | <b>N</b>   |   |           |   |           |                    |  |  |  |
| 0  | <b>270</b> |  |  |  |  |   |           |   |           |                    |  |  |  |
| 1  | 0          |  |  |  |  |   |           |   |           |                    |  |  |  |
|  | 90         |  |  |  |  |   |           |   |           |                    |  |  |  |
|  | 180        |  |  |  |  |   |           |   |           |                    |  |  |  |
|  |            |  |  |  |  |   |           |   |           |                    |  |  |  |

Version: 94

**Face plate**

S1.F656/C10.V9

