

Terminal blocks

Notes for the installation of terminal blocks from Phoenix Contact

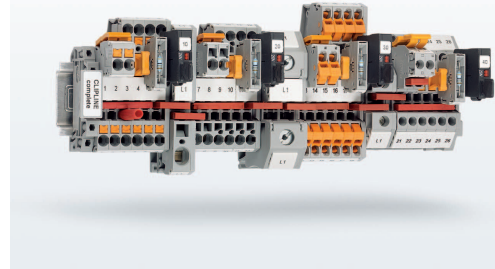

Application note
108769_en_02

© PHOENIX CONTACT 2020-05-19

1 Description

This document provides an overview of the installation of terminal blocks from Phoenix Contact.

It describes how to connect copper wires.

Please also observe the notes printed on the product and the instructions supplied.

Table of contents

1	Description	1
2	Personnel requirements	2
3	Mounting terminal blocks	2
4	Installing terminal blocks	2
4.1	Screw connection	3
4.2	Spring-cage connection	3
4.3	Push-in connection	4
4.4	Fast connection	4
4.5	Bolt connection	5
4.6	Barrier connection	5
5	Distributor terminal block	6
6	Accessories	7
6.1	Bridges	7
6.1.1	Plug-in bridges (FBS...)	7
6.1.2	Insertion bridges (EB...)	7
6.1.3	Chain bridge (KB...)	8
6.1.4	Fixed bridge (FBI...)	8
6.1.5	Step bracket (STL...)	8
6.2	Disconnect points and connectors	8
6.3	Test adapters	8

 Make sure you always use the latest documentation.
It can be downloaded at phoenixcontact.net/products.

2 Personnel requirements

Only electrically qualified personnel may install and operate terminal blocks.

The qualified persons have to be familiar with the basics of electrical engineering. They must be able to recognize and prevent danger.



This symbol on the packaging indicates that only personnel familiar with electrical engineering is allowed to install and operate terminal blocks.

3 Mounting terminal blocks

- When mounting terminal blocks side by side, ensure that the required air clearances and creepage distances are observed. This is particularly important if different sizes or series are mounted side by side.
- Install terminal blocks and accessories in suitable housings. Observe the specifications for touch protection.

DIN rail mounting

- Mount an end bracket onto the DIN rail.
- Snap on the terminal blocks.
- Place terminal blocks with clamp feet onto the DIN rail with the tensioning screw loosened. Tighten the screw to the specified torque.
- For optical or electrical separation, partition plates or covers can be snapped on between the terminal blocks.
- When the terminal blocks are mounted side by side, fit the corresponding cover to the end terminal block with the open half of the housing.
- Finally, snap on another end bracket.

Direct mounting

Some terminal block ranges can be directly screwed to a mounting surface via flanges or securing pins.

- Use suitable screws to secure terminal blocks with flanges on the intended mounting surface.
- For terminal blocks with an open half of the housing, fit the corresponding cover and flange to the end terminal block.

4 Installing terminal blocks

Only use accessories and tools recommended by Phoenix Contact.

Observe the corresponding technical data.

You will find information:

- On the product
- On the packing label
- In the supplied documentation
- On the web at phoenixcontact.net/products under the product
- Packing slips and application notes for the Ex area can be found in the product download area at phoenixcontact.net/products.
- In the catalog

Defective terminal blocks

- Only operate properly working terminal blocks.
- Immediately take defective terminal blocks out of service.
- Replace damaged terminal blocks. Repairs are not possible.

4.1 Screw connection

Series

DIK...	SSK...	UKH...	UT...
MUT...	STU...	UK...	UTI...
			UTME...

Example

Figure 1 Screw connection



Connecting the conductor

- Strip the specified length off the conductors.
- Flexible conductors can be fitted with ferrules.
Crimp the ferrules using crimping pliers. Ensure that the test requirements in accordance with DIN 46228-4 are met.
The length of the ferrule corresponds to the stripping length of the conductor.
- Insert the conductors into the terminal points as far as they will go.
- Tighten the screws of all terminal points. Observe the specified torque.
We recommend to also tighten the terminal points of terminal blocks that are not used.
- If you want to connect more than one conductor per terminal point, check the specifications regarding the connection capacity. The specifications apply to the connection of two conductors of the same cross section and the same conductor type.
- Loosen the terminal screw to open the terminal point and remove the conductor.

4.2 Spring-cage connection

Series

MSB...	MZFK...	STIO...	ZDIK...
MSBV...	ST...	STME...	ZVIOK...
MSDB...	STI...	STU...	

Example

Figure 2 Spring-cage connection



Connecting the conductor

- Strip the specified length off the conductors.
- Flexible conductors can be fitted with ferrules.
Crimp the ferrules using crimping pliers. Ensure that the test requirements in accordance with DIN 46228-4 are met.
The length of the ferrule corresponds to the stripping length of the conductor.
- Push a screwdriver into the angular actuation shaft to open the terminal point.
Use a suitable bladed screwdriver. For tool recommendations, please refer to the accessories.
- Insert the conductor into the round connection opening as far as it will go.
- Remove the screwdriver to establish the conductor connection.
- Reinsert the screwdriver into the actuation shaft to release the conductor.

4.3 Push-in connection

Series

MP...	PT...	PTIO...	PTRV...
MPT...	PTCB...	PTMC...	PTU...
	PTI...	PTME...	PTV...

Example

Figure 3 Push-in connection

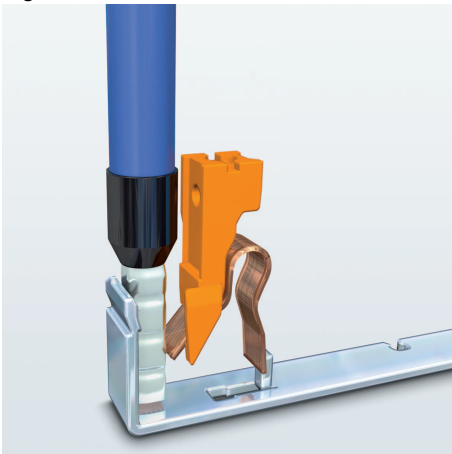

Connecting the conductor

- Strip the specified length off the conductors.
- Flexible conductors can be fitted with ferrules.
Crimp the ferrules using crimping pliers. Ensure that the test requirements in accordance with DIN 46228-4 are met.
The length of the ferrule corresponds to the stripping length of the conductor.
- Rigid conductors and flexible conductors with ferrules can be inserted directly into the round opening of the terminal block without using tools.
- For small conductor cross sections and flexible conductors without ferrules, you first have to open the terminal point.
For this purpose, push the push button down using a bladed screwdriver.

Releasing the conductor

- Push down the push button using a bladed screwdriver to release the conductor.

4.4 Fast connection

Series

QT...
QTC...
QTCU...

Example

Figure 4 Fast connection



Connecting the conductor

Fast connection is suitable for conductors with PVC and PE insulation. Fast connection terminal blocks have an orange swiveling lever.

- Insert the stripped conductor into the round conductor guide from the rotary connection to the stop.
- Insert a bladed screwdriver into the angular orange-colored actuation shaft.
- Rotate the conductor connection to the middle of the terminal block until it snaps into place.

Reconnection

- Before reconnecting the conductor, cut off the wired point of the conductor at an adequate distance.

4.5 Bolt connection

Series

HV... RT... UHV...
 OTTA... RBO...

Example

Figure 5 Bolt connection

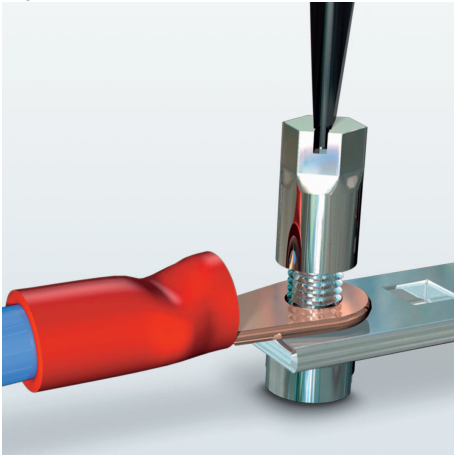

- Strip off the conductor. Provide the conductor with a ring cable lug in accordance with DIN 46234, DIN 46235, or DIN 46237. The stripping length depends on the ring cable lug.
If you connect two conductors, only use cable lugs for crimp connections in accordance with DIN 46235.
- Crimp the ring cable lugs using suitable crimping pliers. Ensure that the test requirements are met.
- Use insulated cable lugs or insulate the cable lugs using a shrink sleeve.
- Insert the ring cable lug, the washer, and the hex nut into the connection point in this order.
- Tighten the hex nut to the specified torque using a socket wrench. For tool recommendations, please refer to the accessories.
- Use a maximum of two cable lugs per bolt.

4.6 Barrier connection

Series

BT...
 BTO...
 BTH...

Example

Figure 6 Barrier connection

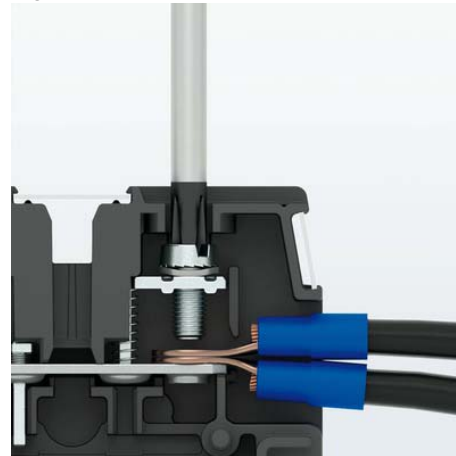

- Strip off the conductors. Provide the conductor with a ring cable lug in accordance with DIN 46234, DIN 46235, or DIN 46237. The stripping length depends on the ring cable lug.
If you connect two conductors, only use cable lugs for crimp connections in accordance with DIN 46235.
- Crimp the ring cable lugs using suitable crimping pliers. Ensure that the test requirements are met.
- Insert the ring cable lug into the connection point.
- Tighten the screw to the specified torque.
- Use a maximum of two cable lugs per bolt.

5 Distributor terminal block

Series

PTU... UDB...
STU... UKH...

Example

Figure 7 Distributor terminal blocks (example)



If you use distributor terminal blocks for power distribution, observe the conditions for reducing the conductor cross sections within a circuit.

Here, the requirements of IEC 60364-4-43 (DIN VDE 0100-430) apply, for example.

6 Accessories

6.1 Bridges

Connect the desired number of positions to form terminal block groups with the same potential. Different bridges can be used for this purpose.

- Plug-in bridge (FBS...)
- Insertion bridge (EB...)
- Chain bridges (KB...)
- Fixed bridges (FBI...)
- Step brackets (STL...)

If neighbored bridges are located directly opposite of each other, you have to fit an insulation plate, a cover, or a partition plate in between. This is necessary to maintain the required air clearances and creepage distances.

From a certain voltage onwards, you have to insert an insulation plate or a cover at the ends of the bridge rail.

If the bridges are used for bridging between non-adjacent terminal blocks, the rated voltage is reduced.

Observe the maximum rated currents when using bridges.

6.1.1 Plug-in bridges (FBS...)

Figure 8 Plug-in bridges

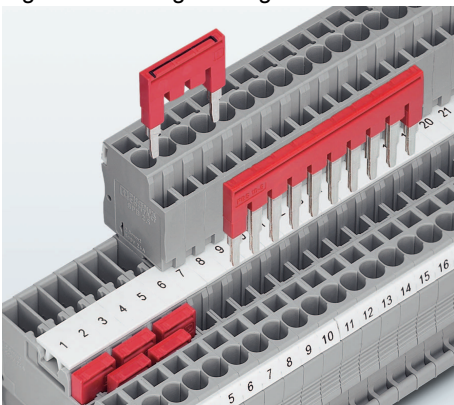

- Connect the desired number of positions to form terminal block groups with the same potential.
- To do so, push a plug-in bridge into the function shaft of the terminal block as far as it will go.
- Terminal blocks with a double function shaft can be used in the same way to implement flexible chain bridging or bridging between non-adjacent terminal blocks.
- When mounting plug-in bridges with more than 20 positions, you must mount the bridge from the outside inwards. First insert the two outer contact tabs into the bridge shaft. Then mount the bridge inwards from both sides.

Bridging between non-adjacent terminal blocks

- Disconnect the contact tab of the bridge for the terminal to be skipped.

Cut-to-length bridges

- If you use cut-to-length bridges, the rated voltage is reduced.
- To maintain the required air clearances and creepage distances, install the intended covers and partition plates.
- If cut-to-length bridges are located directly opposite of each other, you have to fit an insulation plate, a cover, or a partition plate in between.

Reducing bridge

A reducing bridge enables terminal blocks with different rated cross sections to be connected easily. Power blocks can be created using the reducing bridge.

6.1.2 Insertion bridges (EB...)

Figure 9 Insertion bridges

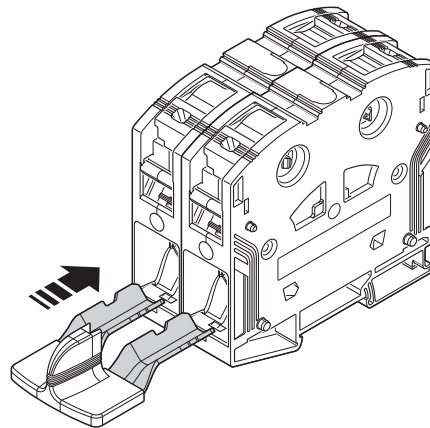

- Insert the bridge into the open terminal points of the terminal blocks as far as it will go.
- Close the terminal point to fasten the bridge in the terminal block.
- Depending on the terminal block type, insert the conductor into the terminal point above or below the bridge metal.
- Note that the maximum connection cross section is generally reduced by one level.

6.1.3 Chain bridge (KB...)

Figure 10 Chain bridges



- Remove the flap on the first chain bridge so that you obtain a support bracket for laying the subsequent bridge.
- After inserting the support bracket into the bridge shaft, mount the other chain bridge.

6.1.4 Fixed bridge (FBI...)

Figure 11 Fixed bridge

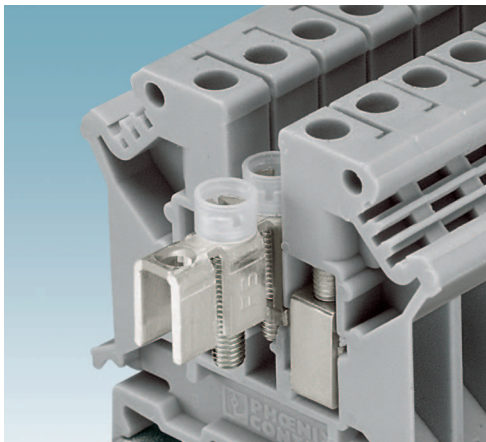

- Insert the fixed bridges into the bridge shaft of the terminal blocks. Tighten the bridge screws to the specified torque.
- You can separate any number of positions from the multi-position bridge strips.

6.1.5 Step bracket (STL...)

Figure 12 Step bracket

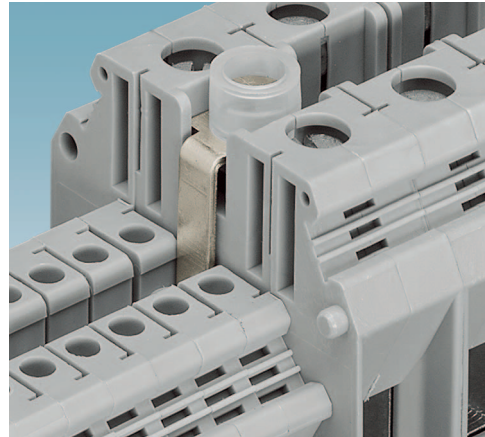

The step bracket enables bridging of terminal blocks of different sizes.

- Mount the step bracket into the bridge shaft of the terminal blocks. Screw tight the step bracket.

6.2 Disconnect points and connectors

- Only operate the disconnect points of test disconnect terminal blocks and connections when the system is at no load and switched off. Exceptions are specified in the documentation.

The maximum current carrying capacity of test disconnect terminal blocks and terminal blocks with connections are often reduced compared to equivalent feed-through terminal blocks.

6.3 Test adapters

- In the case of hazardous voltages, create the test circuit using our test adapters only after the circuit was disconnected.
- After measurement, only dismantle the test circuit when the system is at no load and switched off.