



Pneumatically operated 2/2 way globe valve CLASSIC

- Compact
- Long service life
- Robust actuators with modular accessory program
- Stainless steel housing with flange, thread and weld end connection



Product variants described in the data sheet may differ from the product presentation and description.

Can be combined with

- | | |
|---|--|
|  | Type 8640 ▶
Modular valve island for pneumatics |
|  | Type 8644 ▶
Remote Process Actuation Control System AirLINE |
|  | Type 8697 ▶
Pneumatic control for decentralised automation of ELEMENT process valves |
|  | Type 6012 ▶
Plunger valve 3/2 way direct-acting |
|  | Type 6014 ▶
Plunger valve 3/2 way direct-acting |
|  | Type 8840 ▶
Modular process valve cluster - distribution and collecting |

Type description

The externally piloted globe valve consists of a pneumatically operated piston actuator and a 2/2 way valve body. The actuator is made of PA or, for special operating conditions, PPS. The reliable self-adjusting packing gland provides high sealing integrity. These maintenance-free and robust valves can be retro-fitted with a comprehensive range of accessories for position indication, stroke limitation or manual override.

Table of contents

1. General technical data	3
2. Product versions	4
2.1. Stainless steel body with PA actuator	4
2.2. Stainless steel body with PPS actuator	4
3. Circuit functions	5
4. Approvals	6
5. Materials	6
5.1. Chemical resistance chart – Bürkert resistApp.....	6
5.2. Material specifications	7
6. Dimensions	8
6.1. Actuator	8
Globe valve Type 2012 and valve system On/Off CLASSIC Type 8801-GA.....	8
6.2. Body with flange connection	9
6.3. Body with threaded connection.....	10
6.4. Body with welded connection	11
7. Performance specifications	12
7.1. Fluidic data	12
Overview of fluidic data for flow direction below seat (for gases, steam and liquids).....	12
Pilot pressure diagram with flow direction below seat (control function B).....	13
Overview of fluidic data for flow direction above seat (for gases and steam)	14
Pilot pressure diagram for flow direction above seat (control function A)	14
7.2. Operating limits.....	16
Operating limits Medium temperature and Operating pressure.....	16
Operating limits for ambient and medium temperature.....	17
Operating limits for optional versions	17
8. Product accessories	18
9. Networking and combination with other Bürkert products	19
10. Ordering information	20
10.1. Bürkert eShop – Easy ordering and quick delivery.....	20
10.2. Bürkert product filter.....	20
10.3. Ordering chart flange connection	21
Valves with flow direction below seat	21
Valves with flow direction above seat.....	22
10.4. Ordering chart thread connection.....	23
Valves with flow direction below seat	23
Valves with flow direction above seat.....	24
10.5. Ordering chart welded connection	25
Valves with flow direction below seat	25
Valves with flow direction above seat.....	27
10.6. Ordering chart accessories.....	28
Accessories for 3/2 way pilot valve with banjo bolts.....	28

1. General technical data

Product properties	
Dimensions	Detailed information can be found in chapter "6. Dimensions" on page 8.
Material	Detailed information can be found in chapter "5. Materials" on page 6.
Design	Globe valve
Nominal diameter	DN10...DN100, NPS ¾...NPS 4
Safety setting in case of power failure	Normally closed (control function A), normally open (control function B)
Flow direction	Flow to open (below seat), flow to close (above seat)
Performance data	
Operating pressure	0...25 bar(g), vacuum version up to -0.9 bar (g) (option)
Nominal pressure	PN 25 (DIN EN 1333), Class 150 (DIN EN 1759)
Pilot pressure	2...10 bar(g) (see "7.1. Fluidic data" on page 12)
K _v value	4.7...165 m ³ /h (see "7.1. Fluidic data" on page 12)
Medium data	
Medium	Steam, water, neutral gases, alcohol, oils, fuels, hydraulic fluids, salt solution, alkali solutions, organic solvents, for fuel gases of category I, II and III acc. to Gas Appliances Regulation (EU) 2016/426 and oxygen
Medium temperature	-40...230 °C (see "7.2. Operating limits" on page 16)
Viscosity	Max. 600 mm ² /s
Control medium	Air, neutral gases
Process/Port connection & communication	
Port connection	
Flange connection	DIN EN 1092 - 1 ANSI B 16.5 JIS 10K
Threaded connection	G (DIN ISO 228 - 1) NPT (ASME B1.20.1) RC (ISO 7 - 1)
Welded connection	DIN EN ISO 1127 / ISO 4200 / DIN11866 B DIN 11850 2 / DIN11866 A ASME BPE / DIN 11866 C SMS 3008
Clamp connection	DIN 32676 B (pipe ISO 4200) DIN 32676 A (pipe DIN 11850 2) ASME BPE
Pilot air port	
Actuator size Ø 40(C)	Thread G ½
Actuator size Ø 50(D) ... 225(L)	Thread G ¼
Approvals and certificates	
Conformity	Food contact 1935/2004(EG), FDA Drinking water Pressure equipment directive Gas Appliances Regulation Machinery Directive
Approval	Explosion proof ATEX / IECex
Material certificate	2.2, 3.1
Environment and installation	
Ambient temperature	-10...140 °C (see "2. Product versions" on page 4)
Degree of protection	IP67
Installation position	As required, preferably with actuator in upright position

2. Product versions



2.1. Stainless steel body with PA actuator

Performance data

Maximum pilot pressure

Actuator size 40(C), 50(D), 63(E), 80(F)	10 bar(g)
Actuator size 100(G), 125(H)	7 bar(g)
Actuator size 175(K), 225(L)	6 bar(g)

Medium data

Medium temperature	-10 °C...185 °C, see “7.2. Operating limits” on page 16
--------------------	---

Environment and installation

Ambient temperature	See “7.2. Operating limits” on page 16
Actuator size 40(C)...125(H)	-10 °C...60 °C
Actuator size 175(K), 225(L)	-10 °C...50 °C



2.2. Stainless steel body with PPS actuator

Performance data

Maximum pilot pressure

Actuator size 40(C), 50(D), 63(E), 80(F),	10 bar(g)
Actuator size 100(G), 125(H)	7 bar(g)

Medium data

Medium temperature	-40 °C...230 °C, see “7.2. Operating limits” on page 16
--------------------	---

Environment and installation

Ambient temperature	5 °C...140 °C (continuous operation up to 130 °C), see “7.2. Operating limits” on page 16
---------------------	---

3. Circuit functions

⚠ CAUTION







Risk of damage due to bursting pipes and bursting equipment when the flow is above the seat. In the case of liquid mediums, water hammer can occur causing pipes and the device to burst.

- Do not use valves with flow above the seat for liquid mediums..

Control function (CF)	Description	
Flow direction below seat for liquids, steam and gases		
	<p>CF: A, pneumatically operated on/off valve 2/2 way Flow direction below seat Normally closed by spring force</p>	
	<p>CF: B, pneumatically operated on/off valve 2/2 way Flow direction below seat Normally open by spring force</p>	
Flow direction above seat for steam and gases		
	<p>CF: A, pneumatically operated on/off valve 2/2 way Flow direction above seat Normally closed by spring force</p>	

DTS 1000010970 EN Version: AE Status: RL (released | freigegeben | validé) printed: 14.07.2022

4. Approvals

Approvals	Description
	Food contact Materials in contact with the medium conform to EC Regulation 1935/2004 Materials in contact with the medium conform to FDA (option)
	Drinking water Suitable for use with drinking water for medium temperatures up to 85 °C in accordance with the Drinking Water Ordinance §17 and the assessment principles of the Federal Environment Agency (option).
	Oxygen Suitable for use with gaseous oxygen with medium temperature up to 60 °C and operating pressure up to 20 bar(g) (option)
 	Explosion proof As category 2 device suitable for zone 1/21 and zone 2/22 (option) ATEX: II 2G Ex h IIC T4 Gb II 2D Ex h IIIC T135 °C Db IECEX: Ex h IIC T4 Gb Ex h IIIC T135 °C Db
	Fuel gases Approval according to the European Gas Appliance Regulation (EU) 2016/426, DVGW DIN EN 161 and DIN EN 16678, Class A or Class D, suitable for medium temperature 0...60 °C, ambient temperature -10...140 °C and operating pressure 0...16 bar(g) (option)
	Safety requirements Evaluation of functional safety according to IEC 61508 (on request)

5. Materials

5.1. Chemical resistance chart – Bürkert resistApp

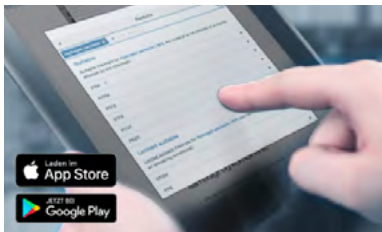

Bürkert resistApp – Chemical resistance chart

You want to ensure the reliability and durability of the materials in your individual application case? Verify your combination of media and materials on our website or in our resistApp.

[Start Chemical Resistance Check](#)

5.2. Material specifications

Actuator size 40...125 mm

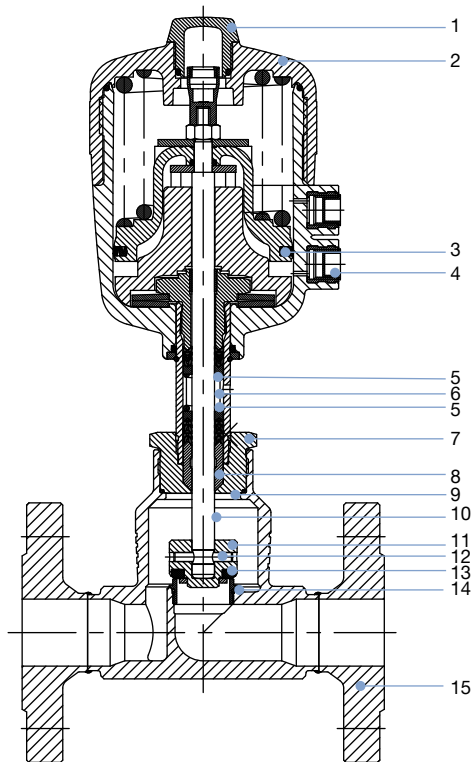

No.	Element	Material	
		Stainless steel with PA actuator	Stainless steel with PPS actuator
1	Optical position indicator	PC	PSU
2	Actuator	PA	PPS
3	Piston seal	NBR	FKM
4	Pilot air ports	Stainless steel 1.4305	
5	Spindle seal	PTFE V-Rings (filled), with spring compensation	
6	Spring	Stainless steel 1.4310	
7	Pipe	Stainless steel 1.4401 or 316L	
8	Wiper	PTFE (filled), PEEK for actuator size 100 mm(G) and 125 mm(H)	
9	Body seal	Graphite, PTFE (Option)	
10	Spindle	Stainless steel 1.4401 or 1.4404	
11	Swivel plate	Stainless steel 1.4401 or 1.4404	
12	Push pin	Stainless steel 1.4401	
13	Seat seal	PTFE, PEEK (option), NBR (option), FKM (option)	
14	Valve seat with O-Ring	Stainless steel 1.4571, EPDM	
15	Valve body	Stainless steel CF3M	

Actuator size 175 and 225 mm

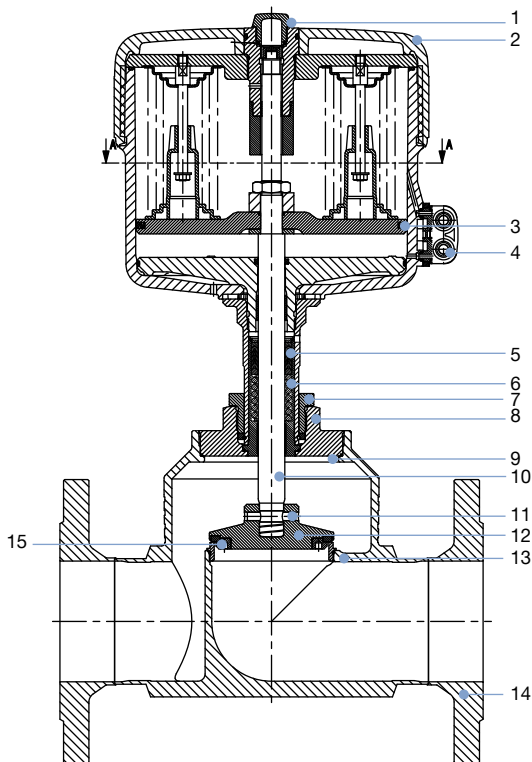

No.	Element	Stainless steel body with PA actuator
1	Optical position indicator	PC
2	Actuator	PA
3	Piston seal	NBR
4	Pilot air ports	Stainless steel 1.4305
5	Spindle seal	PTFE V-Rings (filled), with spring compensation
6	Spring	Stainless steel 1.4568
7	Screw	Stainless steel 1.4305
8	Nipple	Stainless steel 1.4404
9	Body seal	Graphite, PTFE (option)
10	Spindle	Stainless steel 1.4401
11	Push pin	Stainless steel 1.4401
12	Swivel plate	Stainless steel 1.4401
13	Seat seal	PTFE, PEEK (option), NBR (option), FKM (option)
14	Valve seat with O-Ring	Stainless steel 1.4571, EPDM
15	Valve body	Stainless steel CF3M

DTS 1000010970 EN Version: AE Status: RL (released | freigegeben | validé) printed: 14.07.2022

6. Dimensions

6.1. Actuator

Globe valve Type 2012 and valve system On/Off CLASSIC Type 8801-GA

Note:

Dimensions in mm, unless otherwise stated

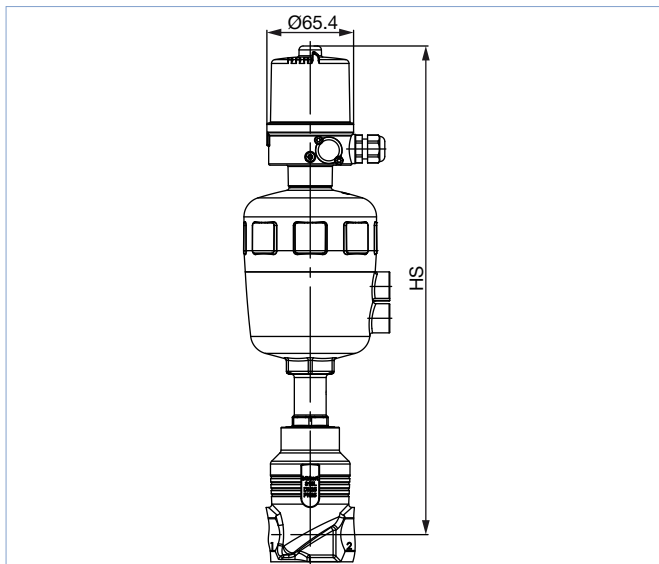
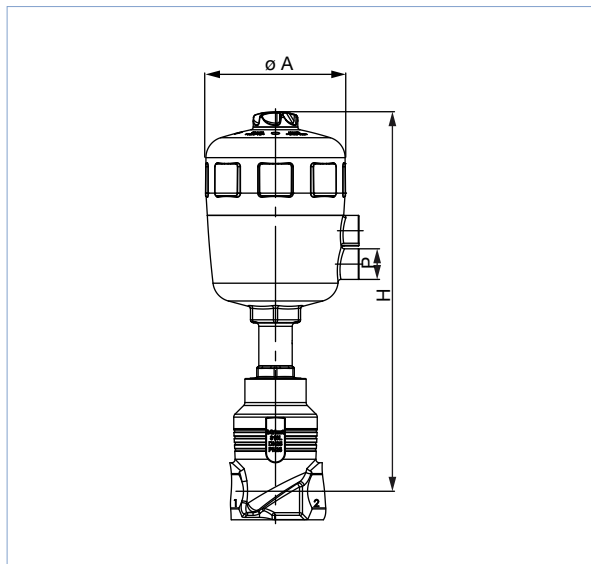

Nominal diameter		Actuator size	ØA	H	P	HS
DN	NPS	[mm]	[mm]	[mm]	[inch]	[mm]
10	3/8	40(C)	53	185	G 1/8	281
		50(D)	64	211	G 1/4	307
		63(E)	80	253	G 1/4	349
15	1/2	40(C)	53	185	G 1/8	281
		50(D)	64	211	G 1/4	307
		63(E)	80	253	G 1/4	349
20	3/4	40(C)	53	187	G 1/8	283
		50(D)	64	214	G 1/4	310
		63(E)	80	248	G 1/4	344
		80(F)	101	270	G 1/4	366
25	1	50(D)	64	220	G 1/4	316
		63(E)	80	251	G 1/4	347
		80(F)	101	273	G 1/4	369
32	1 1/4	63(E)	80	272	G 1/4	368
		80(F)	101	294	G 1/4	390
		125(H)	157	390	G 1/4	483
40	1 1/2	80(F)	101	299	G 1/4	395
		125(H)	157	395	G 1/4	488
50	2	80(F)	101	309	G 1/4	405
		100(G)	127	371	G 1/4	464
		125(H)	157	400	G 1/4	493
65	2 1/2	125(H)	157	429	G 1/4	522
		175(K)	211	491	G 1/4	590
		225(L)	261	486	G 1/4	585
80	3	125(H)	157	438	G 1/4	531
		175(K)	211	498	G 1/4	597
		225(L)	261	494	G 1/4	593
100	4	125(H)	157	449	G 1/4	542
		175(K)	211	508	G 1/4	607
		225(L)	261	504	G 1/4	603

6.2. Body with flange connection

Note:

Dimensions in mm, unless otherwise stated

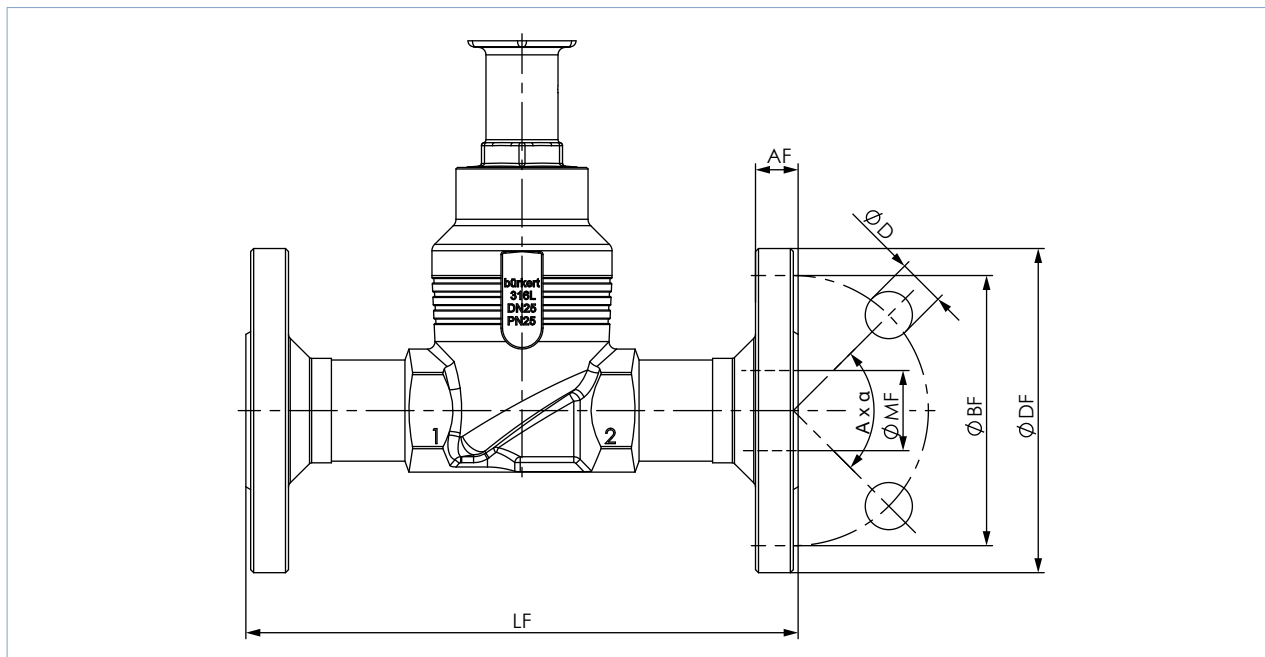

Nominal diameter (pipe)	DIN EN 1092 PN25 FTF 1 acc. to DIN EN 558 - 1							JIS 10K FTF 10 acc. to DIN EN 558 - 2						
	Ø DF	LF	Ø BF	AF	Ø D	A x α	Ø MF	Ø DF	LF	Ø BF	AF	Ø D	A x α	Ø MF
10	90	130	60	16	14	4 x 90°	13.6	-	-	-	-	-	-	-
15	95	130	65	16	14	4 x 90°	18.1	95	108	70	12	15	4 x 90°	18.1
20	105	150	75	18	14	4 x 90°	23.7	100	117	75	14	15	4 x 90°	23.7
25	115	160	85	18	14	4 x 90°	29.7	125	127	90	14	19	4 x 90°	29.7
32	140	180	100	18	18	4 x 90°	38.4	135	140	100	16	19	4 x 90°	38.4
40	150	200	110	18	18	4 x 90°	44.3	140	165	105	16	19	4 x 90°	44.3
50	165	230	125	20	18	4 x 90°	56.3	155	203	120	16	19	4 x 90°	56.3
65	185	290	145	22	18	8 x 45°	66.0	175	216	140	18	19	4 x 90°	71.5
80	200	310	160	24	18	8 x 45°	81.0	185	241	150	18	19	8 x 45°	84.3
100	235	350	190	24	22	8 x 45°	100.0	292	292	175	18	19	8 x 45°	109.1

Nominal diameter (pipe)	ANSI B 16.5 Class 150 FTF 37 acc. to DIN EN 558 - 2						
	NPS	Ø DF	LF	Ø BF	AF	Ø D	A x α
½	89	184	60.5	11.2	15.7	4 x 90°	15.7
¾	99	184	69.9	12.7	15.7	4 x 90°	20.8
1	108	184	79.2	14.2	15.7	4 x 90°	26.7
1½	127	222	98.6	17.5	15.7	4 x 90°	40.9
2	152	254	120.7	19.1	19.1	4 x 90°	52.6
2½	178	276	139.7	22.3	19.1	4 x 90°	62.7
3	190	298	152.5	23.9	19.1	4 x 90°	78.0
4	229	352	190.5	23.9	19.1	8 x 45°	102.4

6.3. Body with threaded connection

Note:

Dimensions in mm, unless otherwise stated

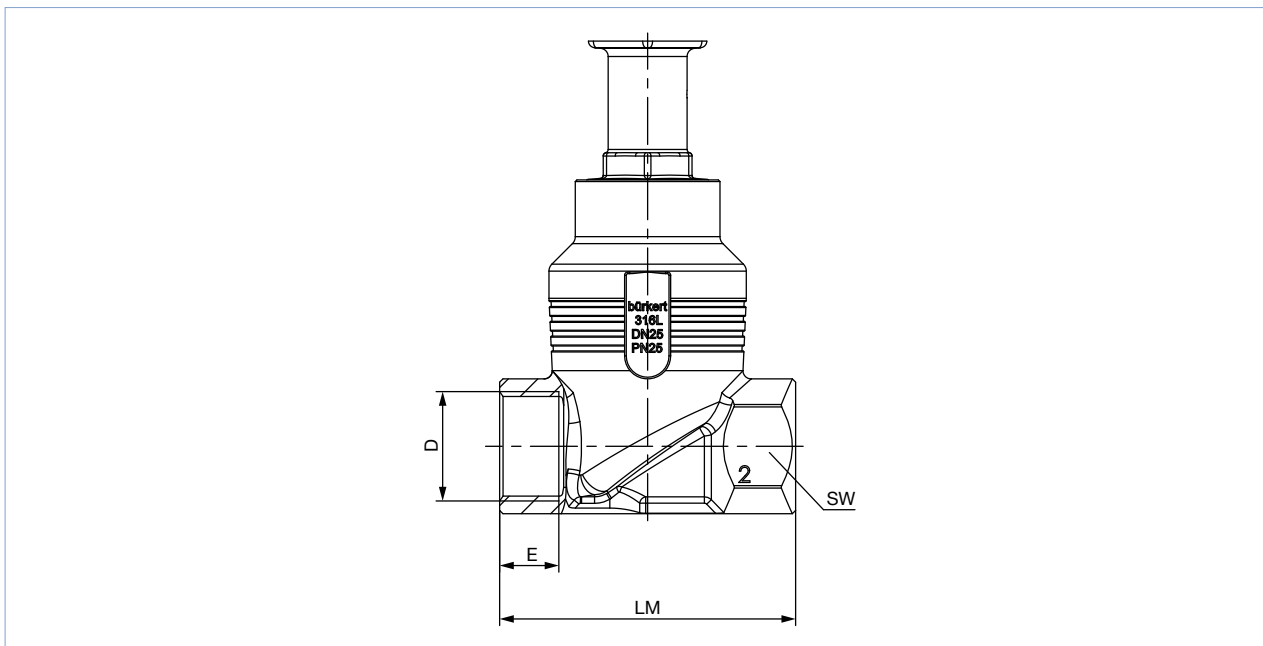

Nominal diameter (pipe)	G, Rc, NPT (EN ISO 228 - 1, ISO 7/1/DIN EN 10226 - 2, ASME B 1.20.1)				LM	SW
	D	E				
DN	NPS	G	NPT	Rc		
10	3/8	12	10.3	10.1	65	27
15	1/2	14	13.7	13.2	65	27
20	3/4	16	14	14.5	75	34
25	1	18	16.8	16.8	90	41
32	1 1/4	20	17.3	19.1	110	50
40	1 1/2	22	17.3	19.1	120	55
50	2	24	17.6	23.4	150	70
65	2 1/2	26	23.7	26.7	185	85
80	3	28	30.5	29.8	205	100
100	4	32	33	35.8	240	125

6.4. Body with welded connection

Note:

Dimensions in mm, unless otherwise stated

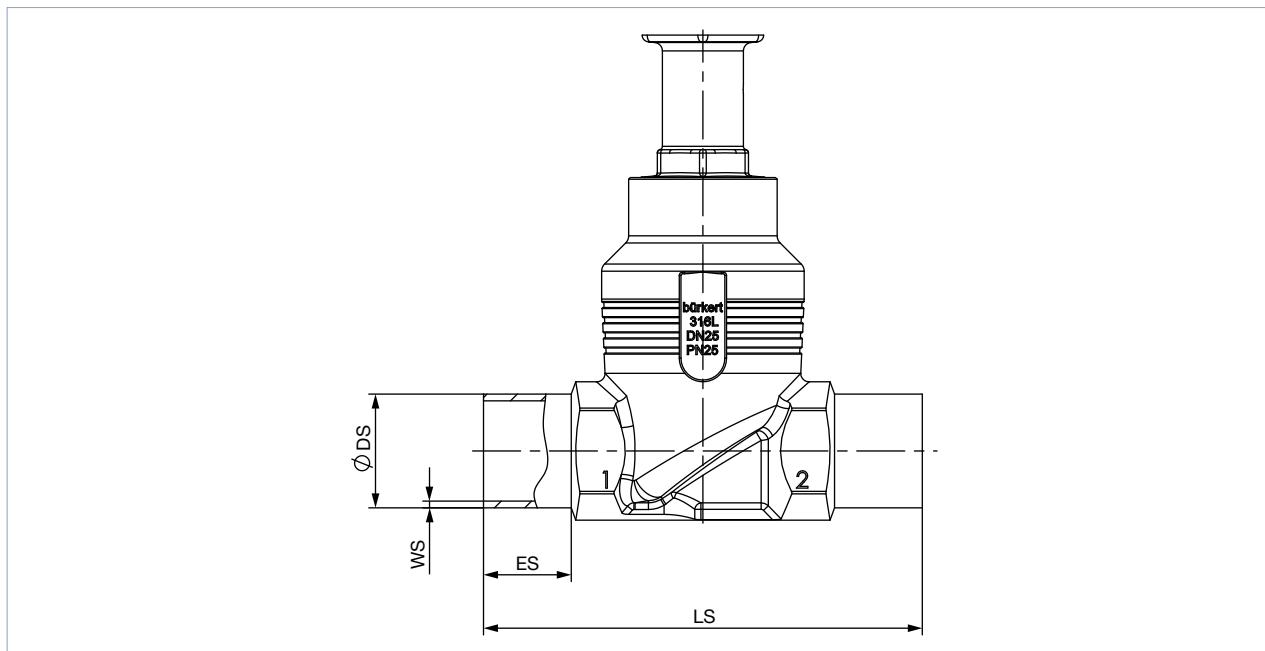

Nominal diameter (pipe) DN	ES	LS	EN ISO 1127 1/ISO 4200/DIN 11866 B		DIN 11850 2/DIN 11866 A/DIN EN 10357 A	
			Ø DS	WS	Ø DS	WS
10	20	90	17.2	1.6	13	1.5
15	20	90	21.3	1.6	19	1.5
20	20	100	26.9	1.6	23	1.5
25	26	130	33.7	2.0	29	1.5
32	26	140	42.4	2.0	35	1.5
40	26	150	48.3	2.0	41	1.5
50	26	175	60.3	2.0	53	1.5
65	26	210	76.1	2.3	70	2.0
80	26	230	88.9	2.3	85	2.0
100	26	260	114.3	2.6	104	2.0

Nominal diameter (pipe) NPS	ES	LS	ASME BPE/DIN 11866 C	
			Ø DS	WS
½	20	90	12.7	1.65
¾	20	90	19.05	1.65
1	20	100	25.4	1.65
1½	26	140	38.1	1.65
2	26	150	50.8	1.65
2½	26	175	63.5	1.65
3	26	210	76.2	1.65
4	26	260	101.6	2.11

DTS 1000010970 EN Version: AE Status: RL (released | freigegeben | validé) printed: 14.07.2022

7. Performance specifications

7.1. Fluidic data

Overview of fluidic data for flow direction below seat (for gases, steam and liquids)

Note:

- K_v value water [m³/h]: Measured with water at +20 °C, 1 bar pressure at valve inlet and free outlet
- Pressure data [bar]: Overpressure to atmospheric pressure

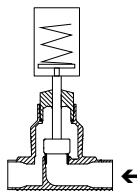

Nominal diameter		Actuator size [mm]	K_v value [m ³ /h]	Pilot pressure min. CF A [bar(g)]	Operating pressure max. [bar(g)]		
DN	NPS				CF: A PTFE	PEEK	CF: B PTFE
10	3/8	40(C)	4.7	4	15	–	16
		50(D)	4.7	4.1	16	16	16
		63(E)	4.7	4.5	25	25	25
15	1/2	40(C)	4.7	4	15	–	16
		50(D)	4.7	4.1	16	16	16
		63(E)	4.7	4.5	25	25	25
20	3/4	40(C)	8.1	4	6.5	–	16
		50(D)	8.1	4.1	11	9	16
		63(E)	8.1	4.5	20	17.5	25
		80(F)	8.1	5	25	25	–
25	1	63(E)	13	4.5	11	10	25
		80(F)	13	5	25	23	25
32	1 1/4	63(E)	20	4.5	6	–	25
		80(F)	20	5	14	12.5	25
		125(H)	20	3.2	25	22.5	–
40	1 1/2	80(F)	31	5	9	–	25
		125(H)	31	4.2	25	–	–
50	2	100(G)	45	4.4	7.2	–	25(20 ^{1.)})
		125(H)	45	5.7	24(20 ^{1.)})	20	–
65	2 1/2	125(H)	73	5.7	12	10	23(15 ^{1.)})
		175(K)	73	4.5	16(15 ^{1.)})	–	25(15 ^{1.)})
		225(L)	73	3.3	25(15 ^{1.)})	–	–
80	3	125(H)	110	5.7	7.5	6.5	14(12.5 ^{1.)})
		175(K)	110	4.5	10	–	24(12.5 ^{1.)})
		225(L)	110	4.8	25(12.5 ^{1.)})	–	–
100	4	125(H)	165	5.7	5	4	9
		175(K)	155	4.5	7	–	15(10 ^{1.)})
		225(L)	155	4.8	16(10 ^{1.)})	–	–

1.) According to pressure equipment directive 2014/68/EU for compressible fluids of group 1 (dangerous gases and vapours according to article 4, paragraph (1), c), i), first indent)

Pilot pressure diagram with flow direction below seat (control function B)

Actuator size Ø40(C)

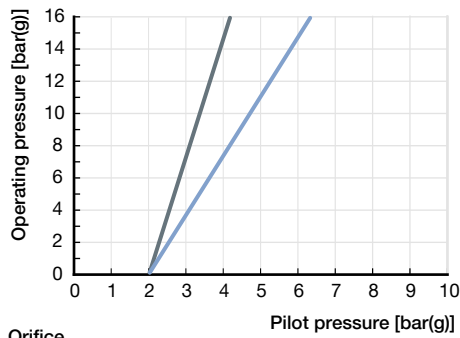

Orifice
 DN10...15 — DN20 —

Actuator size Ø50(D)

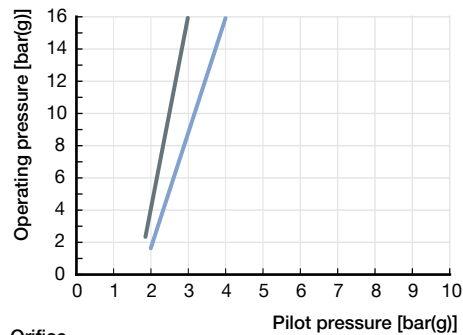

Orifice
 DN10...15 — DN20 —

Actuator size Ø63(E)

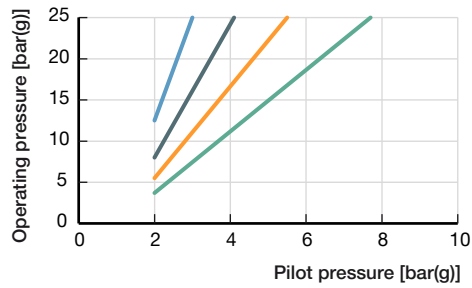

Orifice
 DN15 — DN20 — DN25 — DN32 —

Actuator size Ø80(F)

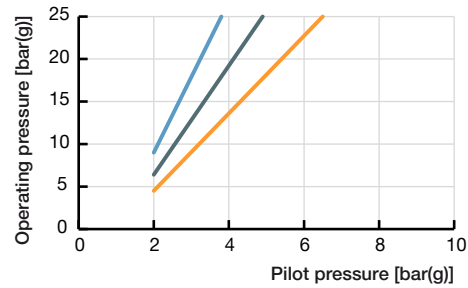

Orifice
 DN25 — DN32 — DN40 —

Actuator size Ø100(G)

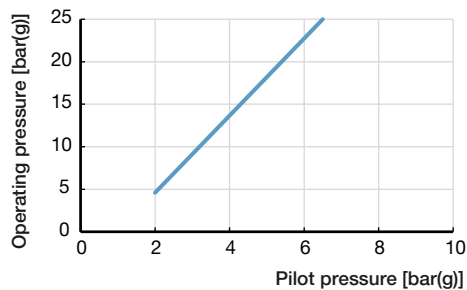

Orifice
 DN50 —

Actuator size Ø125(H)

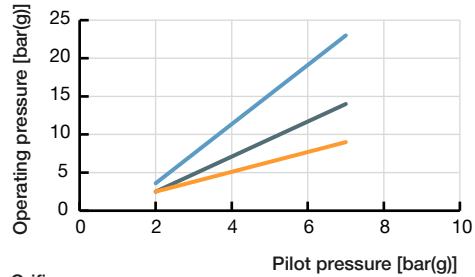

Orifice
 DN65 — DN80 — DN100 —

Actuator size Ø175(K)

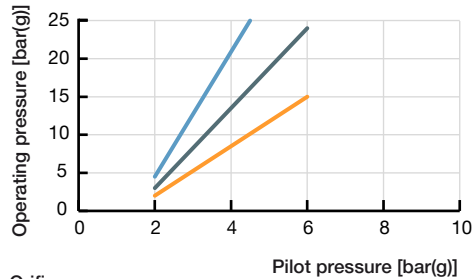

Orifice
 DN65 — DN80 — DN100 —

DTS 1000010970 EN Version: AE Status: RL (released | freigegeben | validé) printed: 14.07.2022

Overview of fluidic data for flow direction above seat (for gases and steam)

Note:

Valves consistent with flow direction above seat are only conditionally applicable for liquid media. There is a risk of water hammer!

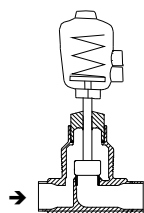

Nominal diameter		Actuator size	K _v value	Operating pressure max.
DN	NPS	[mm]	[m³/h]	CF: A [bar(g)]
10	3/8	40(C)	3	16
		50(D)	3	16
15	1/2	40(C)	4.7	16
		50(D)	4.7	16
20	3/4	40(C)	8.1	16
		50(D)	8.1	16
25	1	50(D)	13	16
32	1 1/4	63(E)	20	16
40	1 1/2	80(F)	31	16
50	2	80(F)	45	16
65	2 1/2	125(H)	73	10
80	3	125(H)	110	10
100	4	125(H)	165	6

Pilot pressure diagram for flow direction above seat (control function A)

Actuator size Ø40(C)

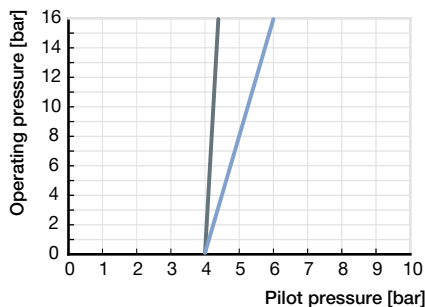

Orifice
 DN10...15 —
 DN20 —

Actuator size Ø50(D)

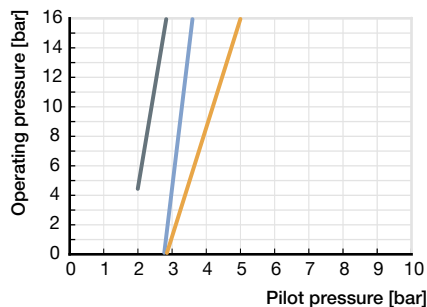

Orifice
 DN10...15 —
 DN20 —
 DN25 —

Actuator size Ø63(E)

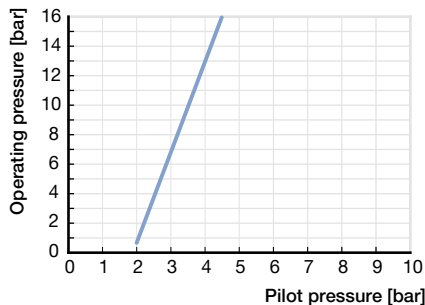

Orifice
 DN32 —

Actuator size Ø80(F)

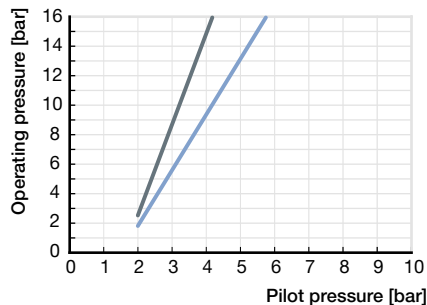

Orifice
 DN40 —
 DN50 —

DTS 1000010970 EN Version: AE Status: RL (released | freigegeben | validé) printed: 14.07.2022

Actuator size Ø125(H)

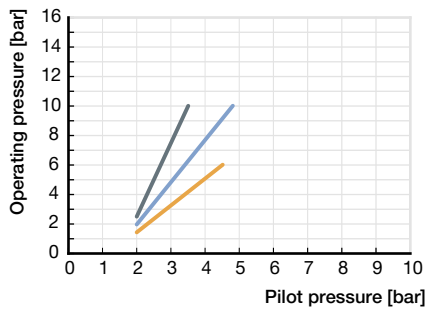

- Orifice
- DN65 —
 - DN80 —
 - DN100 —

7.2. Operating limits

Operating limits Medium temperature and Operating pressure

The operating range of Bürkert process valves is in addition to the maximum operating pressures limited by the nominal pressure according to the relevant standard.

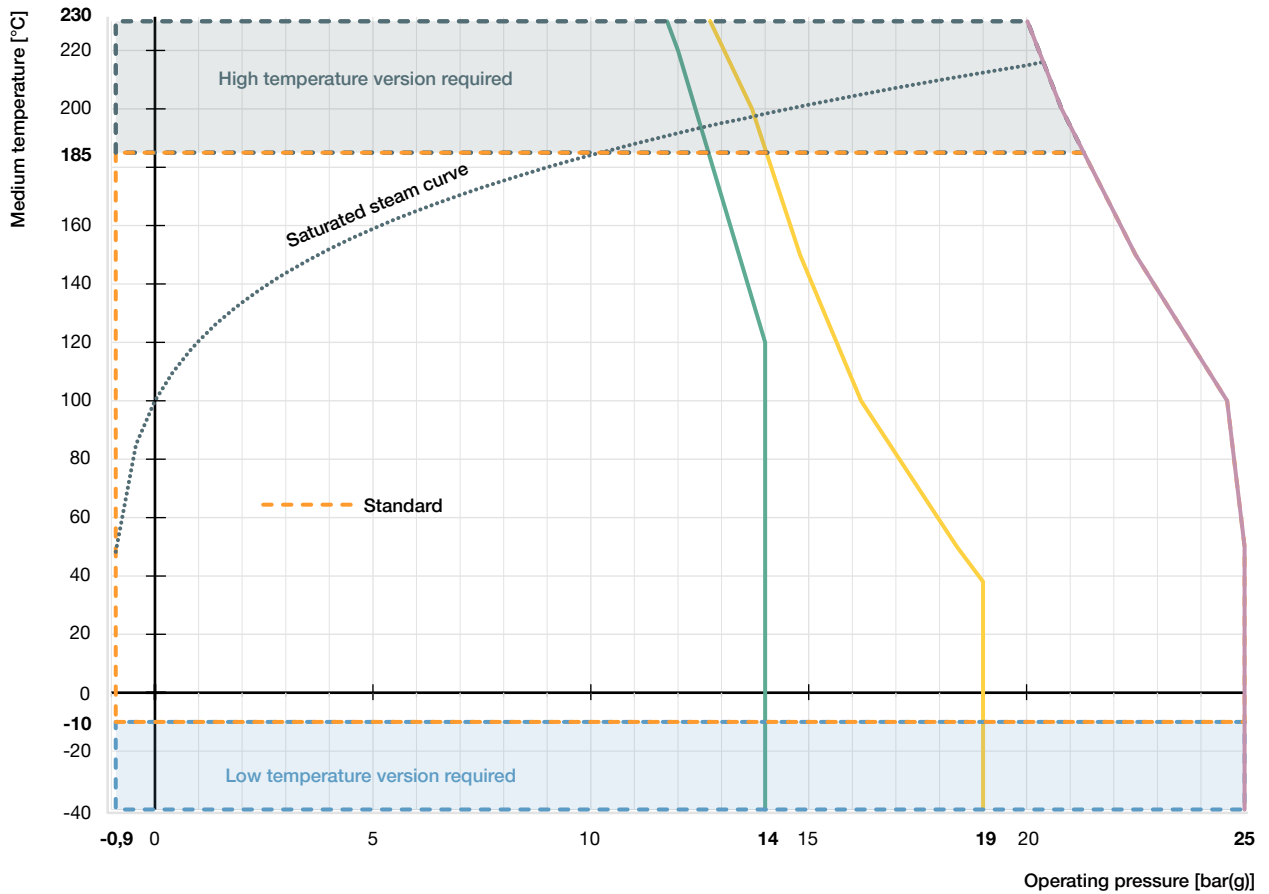

- Operating limits for PN25 acc. to DIN EN 12516-1
- Operating limits for flange 10K acc. to JIS B 2220
- Operating limits for Class 150 acc. to ASME B16.34
- ⋯ Saturated steam curve for water

DTS 1000010970 EN Version: AE Status: RL (released | freigegeben | validé) printed: 14.07.2022

Operating limits for ambient and medium temperature

Note:

For PA actuators of sizes 40, 50 and 63, the combination of maximum medium temperature and maximum ambient temperature is shown in the following diagram:

Classic PA actuator

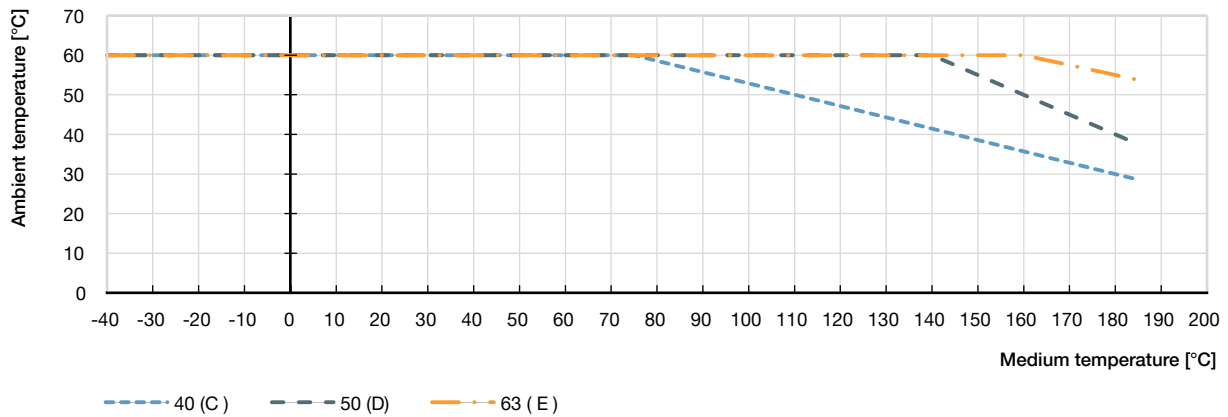

Classic PPS actuator

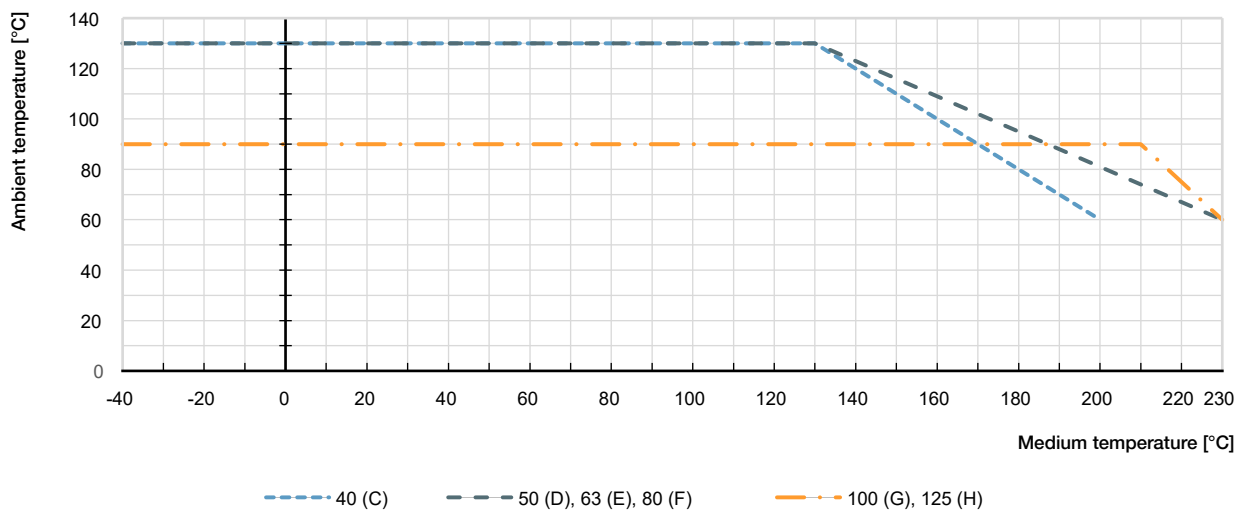

Operating limits for optional versions

High temperature version

By adapting the spindle sealing and seat seal in PEEK, this version is suitable for applications with steam, neutral gases and other heat transfer mediums up to 230 °C.

Hot water version

For applications with hot water up to 200 °C a special configuration of the spindle seal increases the lifetime significantly. It is recommended for water temperatures starting at 85 °C.

Vacuum version

Without leakage bore, this design is suitable down to -0.9 bar(g).

Low temperature version

Suitable for minimum medium temperatures down to -40 °C

8. Product accessories

Electric position feedback sensor	
Type 8697 ▶ Actuator size Ø 40(C)...125(H)	Description The position feedback Type 8697 is designed for integrated mounting on CLASSIC series 20XX process valves suiting the requirements of hygienic process environment Mechanical or inductive limit switches register the position of the valve Features <ul style="list-style-type: none"> • Compact design • LED position indicator • Mechanical or inductive limit switches for end position registering • Easy to clean chemically resistant housing featuring IP65/IP67, 4X Rating • Optional intrinsically safe version acc. to ATEX Customer benefits <ul style="list-style-type: none"> • Easy and quick installation • High level of signal reliability thanks to self adjusting limit switches • Minimised space requirement in the plant piping for more flexibility in plant design
	
Adaptation for proximity switch	
Type 2XXX ▶	Description Various options for the use of inductive proximity switches are available for the actuators of the CLASSIC series: <ul style="list-style-type: none"> • Nipple • Support bracket, 1-fold • Support bracket, 2-fold
	
Plunger valve 3/2 way direct acting	
Type 6012 ▶ for Actuator size Ø 40(C)...63(E) Type 6014 ▶ for Actuator size Ø 50(D)...125(H)	Description For easy direct mounting to a pneumatic actuator, a banjo connection with banjo bolt is the ideal solution. An optional manual override allows fast commissioning and optimum maintenance. In conjunction with a cable plug according to DIN EN 175301 - 803 Form A or B, the valves meet protection class IP65 Features <ul style="list-style-type: none"> • High reliability • Resistant according to IP65 Customer benefits Easy and quick installation
	
Stroke limiter	
Type 2XXX ▶	Description Stroke limitations can be used to limit the minimum (min.) and maximum (max.) flow rate of the valves. Different versions are available: <ul style="list-style-type: none"> • Max. Stroke Limitation • Max. and min. stroke limitation with optical position indicator
	

9. Networking and combination with other Bürkert products

Note:

The globe valve Type 2012 can be combined with the feedback positioner Type 8697 to form the valve system On/Off CLASSIC Type 8801-GA.

Note:

- For the configuration of further valve systems please use the **product enquiry form** at the end of this document.
- You order two components and receive a completely assembled and tested valve.

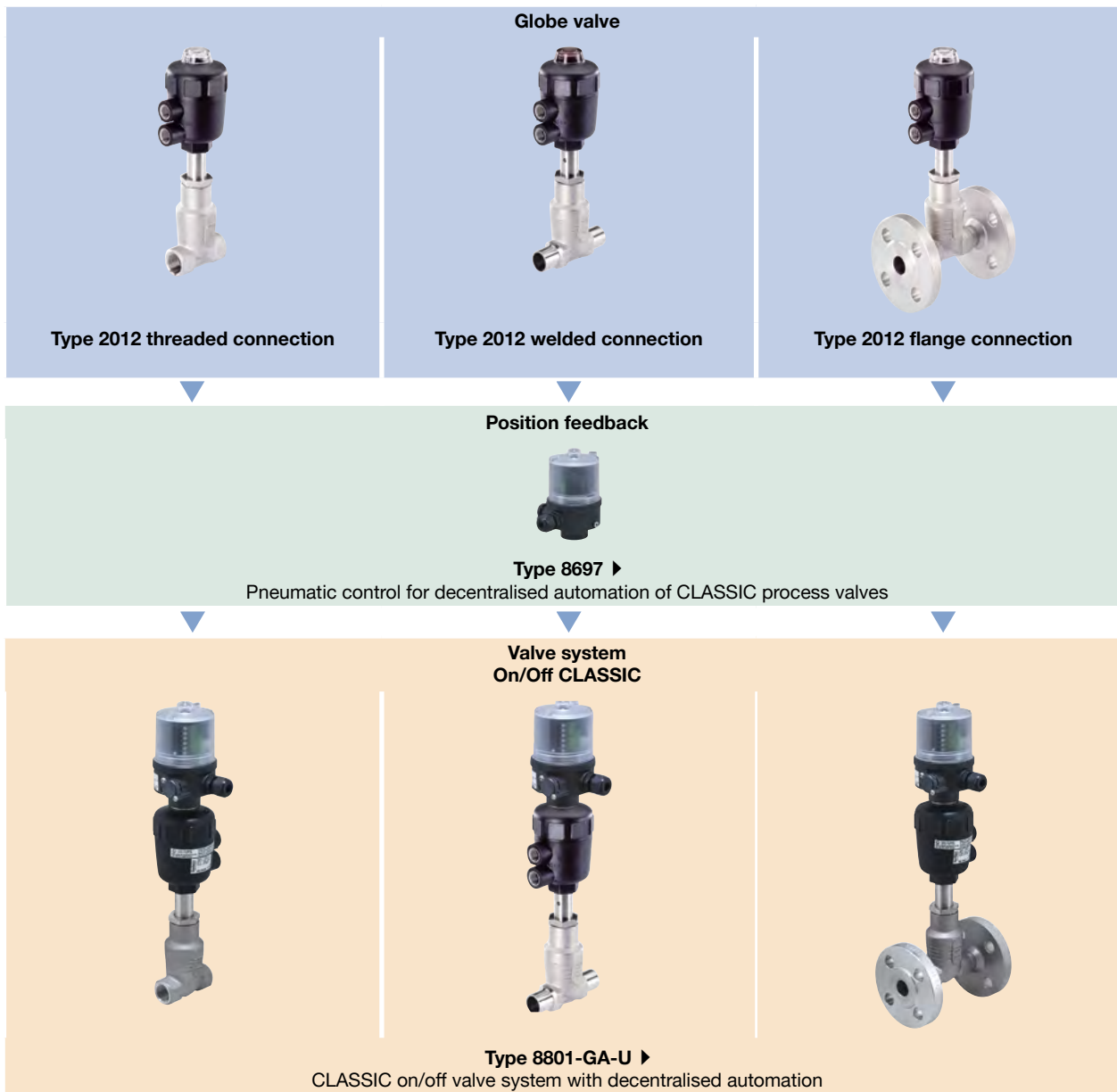

10. Ordering information

10.1. Bürkert eShop – Easy ordering and quick delivery



Bürkert eShop – Easy ordering and fast delivery

You want to find your desired Bürkert product or spare part quickly and order directly? Our online shop is available for you 24/7. Sign up and enjoy all the benefits.

[Order online now](#)

10.2. Bürkert product filter



Bürkert product filter – Get quickly to the right product

You want to select products comfortably based on your technical requirements? Use the Bürkert product filter and find suitable articles for your application quickly and easily.

[Try out our product filter](#)

10.3. Ordering chart flange connection





Valves with flow direction below seat

Control function	Nominal diameter [mm]	Actuator size Ø [mm]	K _v value water [m ³ /h]	Pilot pressure min. [bar(g)]	Operating pressure max. [bar(g)]	Stainless steel body	
						Article no. PA actuator	Article no. PPS actuator
DIN EN 1092-1							
CF: A , see control functions ^{1.)}	10	40(C)	4.7	4.0	15	343814	344096
		50(D)	4.7	4.1	16	343818	344095
	15	40(C)	4.7	4.0	15	343823	On request
		50(D)	4.7	4.1	16	343829	343912
	20	40(C)	8.1	4.0	6.5	344116	On request
		50(D)	8.1	4.1	11	343835	On request
		63(E)	8.1	4.5	20	344117	344119
	25	63(E)	13.0	4.5	11	342307	343965
		80(F)	13.0	5.0	25	343851	344132
	32	63(E)	20.0	4.5	6	343855	On request
		80(F)	20.0	5.0	14	343859	344137
	40	80(F)	31.0	5.0	9	343864	On request
		125(H)	31.0	3.2	25	343869	344163
	50	100(G)	45.0	4.4	7.2	346199	359741
		125(H)	45.0	3.2	10	344071	344178
	65	125(H)	73.0	5.7	12	344183	344185
		175(K)	73.0	4.5	16(15 ^{3.)})	344184	On request
	80	125(H)	110.0	5.7	7.5	343951	344190
		175(K)	110.0	4.5	10	344188	On request
		225(L)	110.0	3.3	16(12.5 ^{3.)})	344189	On request
100	125(H)	165.0	5.7	5	344195	344197	
	175(K)	155.0	4.5	7.0	344193	On request	
	225(L)	155.0	4.8	16(10 ^{3.)})	344194	On request	

1.) Further information in chapter "3. Circuit functions" on page 5.

2.) Detailed information can be found in chapter "Pilot pressure diagram with flow direction below seat (control function B)" on page 13.

3.) According to pressure equipment directive 2014/68/EU for compressible fluids of group 1 (dangerous gases and vapours according to article 4, paragraph (1), c), i), first indent)





Further versions on request	
 Approval Food processing, drinking water, oxygen, fuel gases, explosion protection	 Pressure Other versions for operating pressures up to 25 bar(g) Vacuum version down to -0.9 bar(g)
 Material Seal: NBR, FKM, EPDM	 Temperature High temperature version up to 230 °C Hot water version up to 200 °C Low temperature version down to -40 °C
 Process connection Clamp connection, threaded connection, welded connection	

Valves with flow direction above seat

Control function	Nominal diameter [mm]	Actuator size Ø [mm]	K _v value water [m ³ /h]	Pilot pressure min. [bar(g)]	Operating pressure max. [bar(g)]	Stainless steel body	
						Article no. PA actuator	Article no. PPS actuator
DIN EN 1092-1							
CF: A, see control functions ^{1.)}	10	40(C)	4.7	See footnote ^{2.)}	16	344092	On request
		50(D)	4.7		16	343899	343911
	15	40(C)	4.7		16	344112	On request
		50(D)	4.7		16	343900	342699
	20	40(C)	8.1		16	343902	On request
		50(D)	8.1		16	343903	343913
	25	50(D)	12.0		16	343905	343914
	32	63(E)	20.0,		16	344138	343916
	40	80(F)	31.0		16	342648	344165
	50	80(F)	45.0		16	341405	343917
	65	125(H)	73.0		10	343941	On request
	80	125(H)	110.0		10	343943	On request
	100	125(H)	165.0		6	342703	On request

1.) Further information in chapter "3. Circuit functions" on page 5.

2.) Detailed information can be found in chapter "Pilot pressure diagram for flow direction above seat (control function A)" on page 14.

Further versions on request	
 Approval Food processing, drinking water, oxygen, fuel gases, explosion protection	 Pressure Other versions for operating pressures up to 25 bar(g) Vacuum version down to -0.9 bar(g)
 Material Seal: NBR, FKM, EPDM	 Temperature High temperature version up to 230 °C Hot water version up to 200 °C Low temperature version down to -40 °C
 Process connection Clamp connection, threaded connection, welded connection	

10.4. Ordering chart thread connection

Valves with flow direction below seat





Note:

Further versions on request

Control function	Nominal diameter [mm]	Threaded connection	Actuator size Ø [mm]	K _v value water [m ³ /h]	Pilot pressure min. [bar(g)]	Operating pressure max. [bar(g)]	Stainless steel body	
							Article no. PA actuator	Article no. PPS actuator
CF: A, see control functions ¹⁾	10	G 3/8	40(C)	4.7	4.0	15	343815	343833
			50(D)	4.7	4.1	16	343819	344098
	15	G 1/2	40(C)	4.7	4.0	15	344100	On request
			50(D)	4.7	4.1	16	343901	344102
	20	G 3/4	40(C)	8.1	4.0	6.5	343833	On request
			50(D)	8.1	4.1	11	343836	On request
			63(E)	8.1	4.5	20	344121	344122
	25	G 1	63(E)	13.0	4.5	11	343846	On request
			80(F)	13.0	5.0	25	343852	344133
	32	G 1 1/4	63(E)	20.0	4.5	6	343856	On request
			80(F)	20.0	5.0	14	343860	On request
	40	G 1 1/2	80(F)	31.0	5.0	9	344172	On request
			125(H)	31.0	3.2	16	343870	343894
	50	G 2	100(G)	45.0	4.4	7.2	342873	On request
			125(H)	45.0	3.2	10	343880	343896
65	G 2 1/2	125(H)	65.0	5.7	12	343921	344187	
		175(K)	65.0	4.5	16(15 ²⁾)	344186	On request	

1.) Further information in chapter "3. Circuit functions" on page 5.

2.) According to pressure equipment directive 2014/68/EU for compressible fluids of group 1 (dangerous gases and vapours according to article 4, paragraph (1), c), i), first indent)

Further versions on request	
 Approval Food processing, drinking water, oxygen, fuel gases, explosion protection	 Pressure Other versions for operating pressures up to 25 bar(g) Vacuum version down to -0.9 bar(g)
 Material Seal: NBR, FKM, EPDM	 Temperature High temperature version up to 230 °C Hot water version up to 200 °C Low temperature version down to -40 °C
 Process connection Clamp connection, threaded connection, flange connection	

Valves with flow direction above seat





Note:

There is a risk of water hammer!

Control function	Nominal diameter [mm]	Threaded connection	Actuator size Ø [mm]	K _v value water [m ³ /h]	Pilot pressure min. [bar(g)]	Operating pressure max. [bar(g)]	Stainless steel body	
							Article no. PA actuator	Article no. PPS actuator
CF: A, see control functions ^{1.)}	10	G 3/8	40(C)	4.7	See footnote ^{2.)}	16	20020021	On request
			50(D)	4.7		16	20020075	On request
	15	G 1/2	40(C)	4.7		16	20020080	On request
			50(D)	4.7		16	341406	On request
	20	G 3/4	40(C)	8.1		16	20020091	On request
			50(D)	8.1		16	374604	On request
	25	G 1	50(D)	12.0		16	343906	343915
	32	G 1/4	63(E)	20.0		16	346131	On request
	40	G 1 1/2	80(F)	31.0		16	20020097	On request
	50	G 2	80(F)	45.0		16	343910	On request
	65	G 2 1/2	125(H)	65.0		10	20020103	On request

1.) Further information in chapter "3. Circuit functions" on page 5.

2.) Detailed information can be found in chapter "Pilot pressure diagram for flow direction above seat (control function A)" on page 14.

Further versions on request	
 Approval Food processing, drinking water, oxygen, fuel gases, explosion protection	 Pressure Other versions for operating pressures up to 25 bar(g) Vacuum version down to -0.9 bar(g)
 Material Seal: NBR, FKM, EPDM	 Temperature High temperature version up to 230 °C Hot water version up to 200 °C Low temperature version down to -40 °C
 Process connection Clamp connection, threaded connection, flange connection	

10.5. Ordering chart welded connection





Valves with flow direction below seat

Control function	Nominal diameter [mm]	Welded connection external Ø x Ws [mm]	Actuator size Ø [mm]	K _v value water [m ³ /h]	Pilot pres- sure min. [bar(g)]	Operating pressure max. [bar(g)]	Stainless steel body	
							Article no. PA actuator	Article no. PPS actuator
EN ISO 1127/ISO 4200								
CF: A, see control functions ¹⁾	10	17.2 × 1.6	40(C)	4.7	4.0	15	343816	On request
			50(D)	4.7	4.1	16	343820	343884
	15	21.3 × 1.6	40(C)	4.7	4.0	15	343824	On request
			50(D)	4.7	4.1	16	343830	343886
	20	26.9 × 1.6	40(C)	8.1	4.0	6.5	343834	On request
			50(D)	8.1	4.1	11	343837	On request
			63(E)	8.1	4.5	20	343843	343888
	25	33.7 × 2.0	63(E)	13.0	4.5	11	343847	On request
			80(F)	13.0	5.0	25	343853	343890
	32	42.4 × 2.0	63(E)	20.0	4.5	6	343857	On request
			80(F)	20.0	5.0	14	343861	343893
	40	48.3 × 2.0	80(F)	31.0	5.0	9	343865	On request
			125(H)	31.0	3.2	16	343871	343895
	50	60.3 × 2.0	100(G)	45.0	4.4	7.2	343875	On request
			125(H)	45.0	3.2	10	343881	343897
	65	76.1 × 2.3	125(H)	73.0	5.7	12	343922	343956
			175(K)	73.0	4.5	16(15 ²⁾)	343827	On request
	80	88.9 × 2.3	125(H)	110.0	5.7	7.5	343952	343959
			175(K)	110.0	4.5	10	343932	On request
			225(L)	110.0	4.8	25(12.5 ²⁾)	343934	On request
100	114.3 × 2.6	125(H)	165.0	5.7	5	343954	343961	
		175(K)	155.0	4.5	7.0	343937	On request	
		225(L)	155.0	4.8	16(10 ²⁾)	343939	On request	

Control function	Nominal diameter [mm]	Welded connection external Ø x Ws [mm]	Actuator size Ø [mm]	K _v value water [m ³ /h]	Pilot pres- sure min. [bar(g)]	Operating pressure max. [bar(g)]	Stainless steel body	
							Article no. PA actuator	Article no. PPS actuator
DIN 11850 series 2								
CF: A , see control functions ^{1.)}	10	13 × 1.5	40(C)	4.7	4.0	15	343817	On request
			50(D)	4.7	4.1	16	343821	343885
	15	19 × 1.5	40(C)	4.7	4.0	15	343825	On request
			50(D)	4.7	4.1	16	343831	343887
	20	23 × 1.5	40(C)	8.1	4.0	6.5	On request	On request
			50(D)	8.1	4.1	11	343838	On request
			63(E)	8.1	4.5	20	343844	343889
	25	29 × 1.5	63(E)	13.0	4.5	11	On request	On request
			80(F)	13.0	5.0	25	343854	343891
	32	35 × 1.5	63(E)	20.0	4.5	6	343858	On request
			80(F)	20.0	5.0	14	343862	On request
	40	41 × 1.5	80(F)	31.0	5.0	9	343866	On request
			125(H)	31.0	3.2	16	343872	344087
	50	53 × 1.5	100(G)	45.0	4.4	7.2	343876	On request
			125(H)	45.0	3.2	10	343882	343898
	65	70.0 × 2.0	125(H)	73.0	5.7	12	343923	343958
			175(K)	73.0	4.5	16(15 ^{2.)})	343928	On request
	80	85.0 × 2.0	125(H)	110.0	5.7	7.5	343953	343960
			175(K)	110.0	4.5	10	343933	On request
			225(L)	110.0	4.8	25(12.5 ^{2.)})	343936	On request
100	104.0 × 2.0	125(H)	165.0	5.7	5	343955	343962	
		175(K)	155.0	4.5	7.0	343938	On request	
		225(L)	155.0	4.8	16(10 ^{2.)})	343940	On request	

1.) Further information in chapter "3. Circuit functions" on page 5.

2.) According to pressure equipment directive 2014/68/EU for compressible fluids of group 1 (dangerous gases and vapours according to article 4, paragraph (1), c), i), first indent)

Further versions on request	
 Approval Food processing, drinking water, oxygen, fuel gases, explosion protection	 Pressure Other versions for operating pressures up to 25 bar(g) Vacuum version down to -0.9 bar(g)
 Material Seal: NBR, FKM, EPDM	 Temperature High temperature version up to 230 °C Hot water version up to 200 °C Low temperature version down to -40 °C
 Process connection Clamp connection, threaded connection, flange connection	

Valves with flow direction above seat

Note:

- Valves with flow direction above seat are only suitable for liquid fluids to a limited extent.
- There is a risk of water hammer!

Control function	Nominal diameter	Welded connection external Ø x Ws	Actuator size Ø	K _v value water	Pilot pressure min.	Operating pressure max.	Stainless steel body	
	[mm]						[mm]	[mm]
EN ISO 1127/ISO 4200								
CF: A , see control functions ^{1.)}	10	17.2 × 1.6	40(C)	4.7	See Footnote ^{2.)}	16	342653	On request
			50(D)	4.7		16	20020146	On request
	15	21.3 × 1.6	40(C)	4.7		16	20020156	On request
			50(D)	4.7		16	20020161	On request
	20	26.9 × 1.6	40(C)	8.1		16	20020168	On request
			50(D)	8.1		16	343904	On request
	25	33.7 × 2.0	50(D)	12.0		16	343907	On request
	32	42.4 × 2.0	63(E)	20.0		16	20020175	On request
	40	48.3 × 2.0	80(F)	31.0		16	346297	On request
	50	60.3 × 2.0	80(F)	45.0		16	20020179	On request
	65	76.1 × 2.3	125(H)	73.0		10	20020186	On request
	80	88.9 × 2.3	125(H)	110.0		10	343945	On request
100	114.3 × 2.6	125(H)	165.0	6	343948	On request		
DIN 11850 series 2								
CF: A , see control functions ^{1.)}	10	13 × 1.5	40(C)	4.7	See footnote ^{2.)}	16	20020191	On request
			50(D)	4.7		16	20020198	On request
	15	19 × 1.5	40(C)	4.7		16	20020202	On request
			50(D)	4.7		16	346118	On request
	20	23 × 1.5	40(C)	8.1		16	20020211	On request
			50(D)	8.1		16	20020216	On request
	25	29 × 1.5	50(D)	12.0		16	20011741	On request
	32	35 × 1.5	63(E)	20.0		16	20020217	On request
	40	41 × 1.5	80(F)	31.0		16	20020218	On request
	50	53 × 1.5	80(F)	45.0		16	379466	On request
	65	70.0 × 2.0	125(H)	73.0		10	343942	On request
	80	85.0 × 2.0	125(H)	110.0		10	343946	On request
100	104.0 × 2.0	125(H)	165.0	6	343949	On request		

1.) Further information in chapter "3. Circuit functions" on page 5.

2.) Detailed information can be found in chapter "Pilot pressure diagram for flow direction above seat (control function A)" on page 14.

Further versions on request	
	Approval Food processing, drinking water, oxygen, fuel gases, explosion protection
	Material Seal: NBR, FKM, EPDM
	Process connection Clamp connection, threaded connection, flange connection
	Pressure Other versions for operating pressures up to 25 bar(g) Vacuum version down to -0.9 bar(g)
	Temperature High temperature version up to 230 °C Hot water version up to 200 °C Low temperature version down to -40 °C

10.6. Ordering chart accessories

Accessories for 3/2 way pilot valve with banjo bolts

Note:

- Seal material FKM / NBR
- Complete program see data sheet [6012](#) ▶, [6014](#) ▶, [2507](#) ▶, [2518](#) ▶

Valve for Actuator size Ø	Type	Pilot air ports	Working port (banjo bolt)	Q _{Nn} value air	Pressure range	Electrical coil connection Ind. Std.	Power consumption	Article no.			
								Voltage/Frequency		Cable plug	
								024 V DC	230 V/50	12...24 AC/DC with LED	0...250 AC/DC
[mm]				[l/min]	[bar(g)]		[W]	[V]	[V]	[V]	[V]
40(C)	6012P	Thread G ¼	Thread G ⅛	48	0...10	Type 2507 Form B	4	552295	552298	423849	423845
		Push-in connector Ø6 mm						552287	552286		
50(D)... 63(E)	6012P	Thread G ¼	Thread G ¼	48	0...10	Type 2507 Form B	4	552291	552294	423849	423845
		Push-in connector Ø6 mm						552283	552286		
50(D)... 125(H)	6014P	Thread G ¼	Thread G ¼	120	0...10	Type 2518 Form A	8	424103	424107	314812	314802
175(K)... 225(L)	6014P	G ¼	G ⅛	174	0...6	Type 2518 Form A	8	786014	786015	314812	314802

Bürkert – Close to You

For up-to-date addresses
please visit us at
www.burkert.com

DTS 1000010970 EN Version: AE Status: RL (released | freigegeben | validé) printed: 14.07.2022



Product Enquiry Form - Pneumatic Shut-off Valves

Thank you for your interest in our products! In order to provide you with optimum advice, please fill out the following form and send it to your **Bürkert representative** or e-mail address: info@burkert.com. All information submitted will of course be kept strictly confidential.

Please fill in the required fields! *

*Note: The interactive functions of this PDF may be restricted depending on the PDF reader used.

Personal Information			
Company		Contact person	
Customer no.		Department	
Street		Postcode / Town	
Telephone no.		Email	

Delivery	
Quantity	Required delivery date

Operating data			
Function <small>(Function of the control valve in the process / process description)</small>			
Pipeline	DN	PN	
Operating medium			
Type of medium	Fluid	Steam	Gas
Operating pressure	Unit		
Medium temperature	°C / °F		
Ambient temperature	°C / °F		

Valve body				
Construction	Angle seat valve		Globe valve	
Actuator material	Stainless steel/PPS		Stainless steel	PPS PA
Housing material	Stainless steel		Gunmetal	
Seat seal	PTFE EPDM		NBR Other	PEEK FKM
DN / Nominal pressure	DN		PN	
Flow coefficient	K_v	m^3/h	C_v	GPM(US)
Connection	Flange	DIN EN 1092-1		ANSI B16.5 JIS 10K
	Thread	G		NPT RC
	Weld	DIN EN ISO 1127 / ISO 4200		DIN 11850 2 / DIN 11866 A ASME BPE
	Clamp	ASME BPE		DIN 32676 A (tube ISO 4200) DIN 32676 B (tube DIN 11850)
	Other			

Valve data	
Circuit Function	A: Normally closed B: Normally open I: Double acting
Control pressure	Min. Max.

DTS 1000010970 EN Version: AE Status: RL (released | freigegeben | valide) printed: 14.07.2022

Approvals / Conformities

For use with food (conform to EG regulation no. 1935/2004)
For use with food (conform to FDA)
Explosion protection in accordance with ATEX II 2GD mech. / IECex
European Gas Appliances Directive (EU) 2016/426, DVGW DIN EN 161 and DIN EN 16678
Suitable for drinking water ^{1.)}
Certificate for the fulfilment of the order EN-ISO 10204 2.1 (Article no. 440788)
Test report EN-ISO 10204 2.2 (Article no. 803722)
Conformity certification for raw material EN-ISO 10204 3.1 (included)

1.) For use with drinking water for medium temperatures up to 85 °C in accordance with the Drinking Water Ordinance §17 and the assessment principles of the Federal Environment Agency.

Additional Requirements / Comment

DTS 1000010970 EN Version: AE Status: RL (released | freigegeben | validé) printed: 14.07.2022

Control heads / pneumatic control for on/off process valves of the CLASSIC series

For actuator size ø40 to 225 mm

Electrical position feedback Type 8697 ▶



- Optical position indicator
- Mechanical or inductive limit switches for end position registering
- Optional intrinsically safe version acc. to ATEX / IECEx

Electrical connection

Cable gland

M12 connector^{1.)}

Number of end position feedback switches

2x Micro or inductive

Approvals

ATEX cat. 3GD, IECEx

ATEX cat. 2DG, IECEx

Without

Position feedback switch

Micro switch 24 V DC

Micro switch 50...225 V DC/AC

Inductive switch 3-wire PNP

Inductive switch 2-wire NAMUR

Inductive switch 2-wire 24 V DC

Without

1.) Applicable only with inductive switch 3-wire PNP