

## Type 7012

3/2-way solenoid valve  
3/2-Wege-Magnetventil  
Électrovanne 3/2 voies



Operating Instructions

Bedienungsanleitung  
Manuel d'utilisation

## Contents

1	About these instructions .....	2
2	Intended use .....	3
3	Basic safety instructions .....	4
4	Technical data .....	5
5	Installation .....	7
6	Disassembly .....	11
7	Maintenance, troubleshooting .....	12
8	Spare parts .....	12
9	Transportation, storage, disposal .....	13

## 1 ABOUT THESE INSTRUCTIONS

The operating instructions contain important information.

- ▶ Carefully read these instructions and follow the safety instructions.
- ▶ Store the instructions in such a way that they are available to all users.
- ▶ Liability and warranty for the device will be invalidated if the operating instructions are not followed.

### 1.1 Symbols

- ▶ designates instructions to avoid danger.
- designates a procedure which you must carry out.



#### **DANGER**

Imminent danger! Serious or fatal injuries.



#### **WARNING**

Potential danger! Serious or fatal injuries.



#### **CAUTION**

Danger! Moderate or minor injuries.

## NOTE

Warns of damage.



Important tips and recommendations.



Refers to information in these operating instructions or in other documentation.

## 1.2 Definition of the term "device"

Term	in these instructions stands for
Device	the 3/2-way solenoid valve Type 7012

## 1.3 Warranty

A precondition for the warranty is that the device is used as intended in consideration of the specified operating conditions.

## 2 INTENDED USE

The 3/2-way solenoid valve Type 7012 is designed for blocking, dosing, filling and ventilating neutral gaseous and liquid media.

- ▶ Use the device only as intended. Non-intended use of the device may be dangerous to people, nearby equipment and the environment.
- ▶ Do not use the device outdoors.
- ▶ When using the device, observe the permitted data, operating conditions and application conditions. This information can be found in the contractual documents, the operating instructions and on the type label.
- ▶ Use the device only in conjunction with third-party devices and components recommended or approved by Bürkert.
- ▶ The device must only be used when in perfect condition; always ensure proper storage, transportation, installation and operation.

### 3 BASIC SAFETY INSTRUCTIONS

These safety instructions do not make allowance for any contingencies and events which may arise during installation, operation and maintenance.

The operator is responsible for observing the location-specific safety regulations, also with reference to personnel.



#### **Risk of injury due to high pressure in the system or device.**

- ▶ Before working on the system or device, switch off the pressure and ventilate and empty the lines.

#### **Risk of injury due to electric shock.**

- ▶ Before working on the device or system, switch off the power supply and secure to prevent reactivation.
- ▶ Observe the applicable accident prevention regulations and safety regulations for electrical devices.

#### **Risk of burns or fire from hot device surfaces due to prolonged operation.**

- ▶ Keep the device away from highly flammable substances and media and do not touch with bare hands.

#### **Risk of injury due to malfunctioning valves that operate with alternating current (AC).**

A seized core causes the solenoid to overheat, which leads to functional failure.

- ▶ Monitor the working process for proper function.

#### **General hazardous situations.**

Ensure the following the prevent injuries:

- ▶ The device only when it is in perfect condition and in accordance with the operating instructions.
- ▶ Do not make any internal or external changes to the device and do not subject it to mechanical stress.
- ▶ Secure device or system to prevent unintentional activation.
- ▶ Make sure only trained technicians carry out installation and maintenance work.
- ▶ Install the valves according to the regulations applicable in the respective country.
- ▶ After an interruption in the power supply, ensure that the process is restarted in a controlled manner.
- ▶ Observe the general rules of technology.

## 4 TECHNICAL DATA

### 4.1 Conformity



Conformities for the solenoid valve Type 7012 can be viewed on the Bürkert homepage at [www.burkert.com](http://www.burkert.com)

### 4.2 Operating conditions



#### WARNING

**Risk of injury due to malfunction if used outdoors.**

- ▶ Do not use the device outdoors and keep it away from heat sources that could cause the permissible temperature range to be exceeded.

Ambient temperature	see type label
Medium temperature	see data sheet
Media	neutral gaseous and liquid media that do not attack the housing and seal materials, see resistance table at: <a href="http://www.country.burkert.com">www.country.burkert.com</a>
Viscosity	max. 21 mm <sup>2</sup> /s
Degree of protection	IP65 as per EN 60529 with cable plug

### 4.3 Mechanical data

Dimensions	see data sheet
Body material	see type label
Seal material	see type label

### 4.4 Fluidic data

Circuit functions

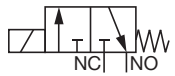
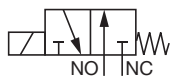
C (NC)		3/2-way valve, closed in rest position, outlet A relieved
D (NO)		3/2-way valve, outlet B pressurized in rest position

Pressure range	see type label
Port connections	see type label

## 4.5 Electrical data

Solenoid dimensions	Solenoid 20 mm (SG2)	Solenoid 24.5 mm (SG3)
Ports	DIN EN 175301-803, design form C: for cable plug 2516 Industry standard, design form B: for cable plug 2507 Flat-pin terminal as protection class III Stranded port on request	
Operating voltage	see type label	
Voltage tolerance	±10%	
Nominal power	2 W to 6.5 W	2 W to 7 W
Nominal operating mode	Continuous operation: 100% duty cycle	

## 4.6 Device identification

### 4.6.1 Type label

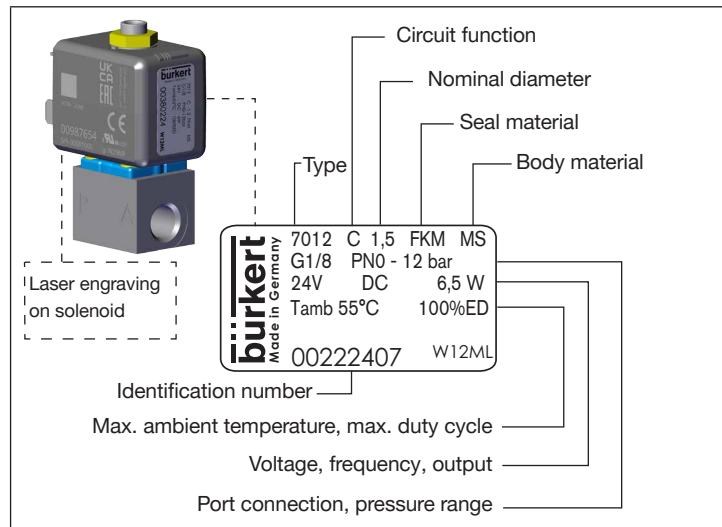

Fig. 1: Description of the type label (example)

## 4.6.2 Laser engraving of solenoid AC08

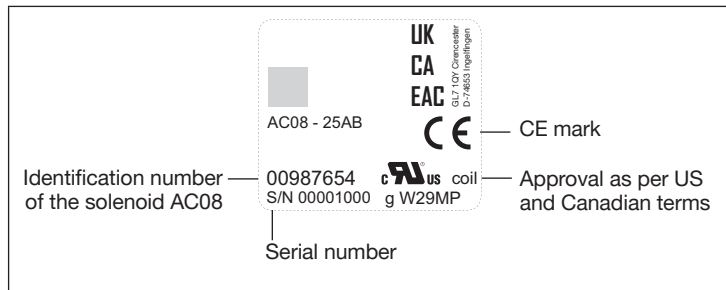

Fig. 2: Description of laser engraving on solenoid AC08

## 4.7 Approvals

All solenoid AC08 marked with cURus are certified in accordance with US and Canadian terms.



Identification of the solenoid is not necessarily linked with the approval of the valve.

## 5 INSTALLATION



### DANGER

**Risk of injury due to high pressure in the system or device.**

- ▶ Before working on the system or device, switch off the pressure and ventilate and empty the lines.

**Risk of injury due to electric shock.**

- ▶ Before working on the system or device, switch off the power supply and secure to prevent reactivation.
- ▶ Observe the applicable accident prevention regulations and safety regulations for electrical devices.
- ▶ Only connect protection class III devices (without protective conductor) to SELV or PELV power sources.
- ▶ Only use cable plug for matching solenoid variant. Cable plug B must not be used for a protection class III device.



## WARNING

Risk of injury due to improper installation.

- ▶ Installation may only be performed with trained technical personnel with suitable tools.
- ▶ Secure the system against unintentional activation.
- ▶ Following installation, ensure a controlled restart.

## 5.1 Connect device fluidically

Installation position: any, preferably solenoid facing upward.

- Check pipelines for soiling and clean if required.
- Install a dirt trap to protect against disruptions (mesh width: 0.2–0.4 mm).



Note flow direction.

Letters on the housing indicate the flow direction:  
from 1(P) → 2(A).

## 5.1.1 Devices with threaded connection

### NOTE

Caution: risk of breakage.

- ▶ Do not use the solenoid as a lever arm.

- Seal the thread with PTFE tape.
- Hold the device on the housing using an open-end wrench and screw into the pipeline.

## 5.1.2 Devices with flange connection

- Remove protective cover.
- Loosen nut and remove solenoid.



## WARNING

Risk of injury due to medium leak.

- ▶ Ensure that the seals provided fit the valve properly.
- ▶ Ensure that the manifold is level.
- ▶ Ensure sufficient surface quality of the manifold.

- Insert the seal into the housing.
- Screw the housing onto the manifold, observing the maximum tightening torque of 1 Nm.



→ Place the solenoid on it and fasten the nut, observing the maximum tightening torque of 2.8 Nm.

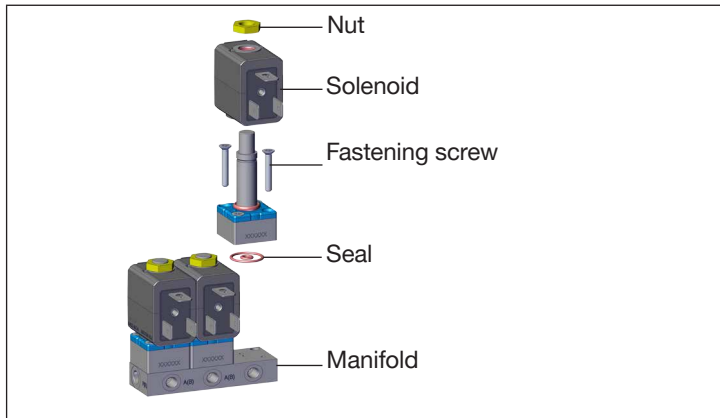

Fig. 3: Installing the devices with a flange connection

## 5.2 Connect device electrically



### WARNING

**Risk of injury due to electric shock.**

- ▶ Before working on the system or device, switch off the power supply and secure against reactivation.
- ▶ Observe the applicable accident prevention regulations and safety regulations for electrical devices.

**Risk of electric shock if protective conductor not connected.**

- ▶ Always connect protective conductor.
- ▶ Check electrical continuity between solenoid and housing.

- Connect the protective conductor.
- Attach seal and check that it fits properly.
- Screw on the cable plug (see data sheet for approved types), observing the maximum tightening torque of 0.3 Nm.
- Check electrical passage.

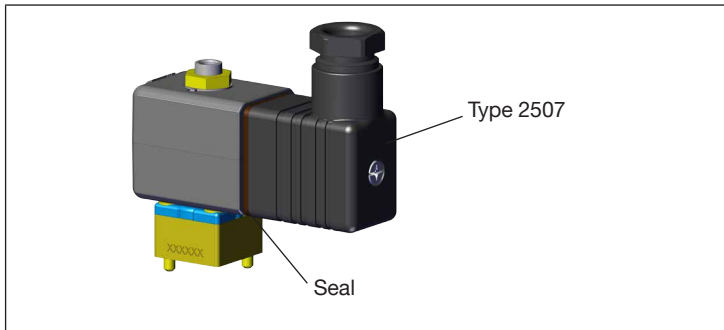

Fig. 4: Electrical connection

### 5.3 Rotate the solenoid



#### WARNING

**Risk of injury due to electric shock.**

If there is no protective conductor function between the solenoid and housing, there is a risk of electric shock.

- ▶ Check the protective conductor function after installing the solenoid.

**Risk of injury due to overheating or fire hazard.**

Connecting the solenoid without first installing the armature will lead to overheating and will destroy the solenoid.

- ▶ Only connect the solenoid after the armature has been installed.

The solenoid can be rotated by 4 x 90°. 2 x 180° in case of a block installation.

- Loosen the nut.
- Rotate the solenoid.
- Screw in the nut with an open-end wrench, observing the maximum tightening torque of 2.8 Nm.

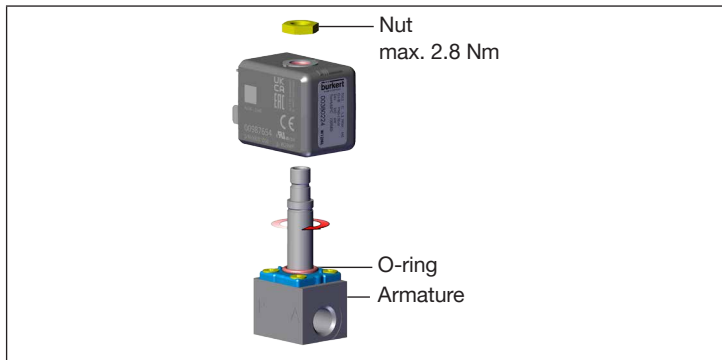

Fig. 5: Rotating the solenoid

## 6 DISASSEMBLY



### DANGER

**Risk of injury due to high pressure in the system or device.**

- ▶ Before working on the system or device, switch off the pressure and ventilate and empty the lines.

**Risk of injury due to electric shock.**

- ▶ Before working on the system or device, switch off the power supply and secure to prevent reactivation.

**Risk of injury due to improper disassembly.**

- ▶ Disassembly may be carried out by authorized technicians only.

→ Shut off the pressure and vent the lines.

→ Switch off the electrical voltage.

→ Remove the cable plug.

**Devices with threaded connection**

→ Hold the device on the housing using an open-end wrench and screw out from the pipeline.

**Devices with flange connection**

→ Loosen nut and remove solenoid.

→ Remove the housing from the manifold.

## 7 MAINTENANCE, TROUBLESHOOTING



### DANGER

Risk of injury if maintenance work is not carried out correctly.

- ▶ Maintenance may be carried out only by trained specialist technicians and with the appropriate tools.
- ▶ Secure the system against unintentional activation.
- ▶ Ensure a controlled restart after maintenance is completed.

### 7.1 Faults

Check in case of faults:

- the line connections,
- the operating pressure,
- the power supply.

If the valve still does not actuate, contact your local Bürkert Service representative.

## 8 SPARE PARTS



### CAUTION

Risk of injury and/or damage due to incorrect parts.

Incorrect accessories and unsuitable spare parts may cause injuries and damage the device and the area around it.

- ▶ Use only original accessories and original spare parts from Bürkert.

The solenoid and armature can be ordered with the device's identification number. Wearing part set on request.

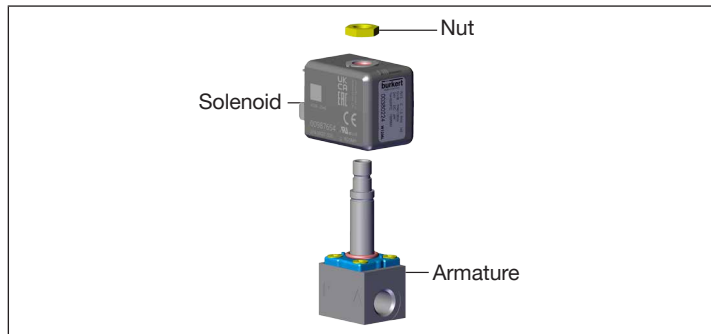

Fig. 6: Spare parts

## 9 TRANSPORTATION, STORAGE, DISPOSAL

### NOTE

#### **Damage in transit due to inadequately protected devices.**

- ▶ Protect the device against moisture and dirt in shock-resistant packaging during transport.
- ▶ Seal electrical interfaces with protective caps.
- ▶ Observe permitted storage temperature.

#### **Incorrect storage may damage the device.**

- ▶ Store the device in a dry and dust-free location.
- ▶ Storage temperature: -40 to +80 °C.

#### **Damage to the environment caused by parts contaminated with media.**

- ▶ Dispose of the device and packaging in an environmentally friendly manner.
- ▶ Observe applicable disposal and environmental regulations.

Bürkert Fluid Control Systems  
Sales Center  
Christian-Bürkert-Str. 13-17  
D-74653 Ingelfingen  
Tel. + 49 (0) 7940 - 10 91 111  
Fax + 49 (0) 7940 - 10 91 448  
E-mail: [info@burkert.com](mailto:info@burkert.com)

International address  
[www.burkert.com](http://www.burkert.com)

Manuals and data sheets on the Internet: [www.burkert.com](http://www.burkert.com)  
Bedienungsanleitungen und Datenblätter im Internet: [www.buerkert.de](http://www.buerkert.de)  
Manuel d'utilisation et fiches techniques sur Internet : [www.burkert.fr](http://www.burkert.fr)

© Bürkert Werke GmbH & Co. KG, 2008 - 2021  
Operating Instructions 2106/01\_EU-ML\_00815362 / Original DE

[www.burkert.com](http://www.burkert.com)